



BOOKS^{TO}_{GO}

MOBILE APP USER MANUAL FOR ANDROID USERS

Table of Contents

1. Introduction	3
2. Getting Started	4
A. Minimum System and Hardware Requirements	4
B. Download the AGCO Parts To Go app and obtain a login.....	4
C. Logging in to the app.....	5
3. Using the App	6
A. Home Screen	6
B. Searching and Sorting the Catalogs Filter	7
C. Searching the Catalogs	8
D. Viewing Catalog Content	11
E. Using the Shopping Cart	16
F. Dealer Business System / Dealer Management System	18
G. Changing The App Settings.....	19
H. Frequently Asked Questions.....	21

1. INTRODUCTION

Parts Books To Go is AGCO's mobile app to present electronic Parts Catalog information on an Android device for AGCO's Dealer/Distribution network or Customers around the world. The app provides interactive parts catalogs which present exploded view drawings. The drawings contain hotspots which are associated directly to part numbers for AGCO branded models allowing you to easily and quickly find AGCO Parts. Searches are enabled by Brand, Book Title (Model), Book Code, Page Title, Part Number, Part Description, and Serial Number (for select Brands). The app also enables you to create a parts list that you can easily email. This app will present the AGCO cornerstone brands which include Challenger, Fendt, Massey Ferguson and Valtra along with the ancillary brands (Ag-Chem, Spra-Coupe, Fella, Laverda, Gleaner, Hesston, etc).

Key features of the app allow you to:

- Easily search (find) parts for your machine
- Create a parts list
- Send parts list to an e-mail of choice
- Supports on-line and off-line book viewing
- Multi-language support

The data residing in the Books To Go app will be synchronized with EPSILON / AGCO Parts Book data on a weekly basis.

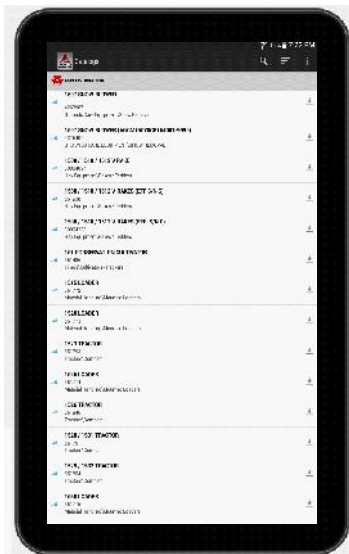
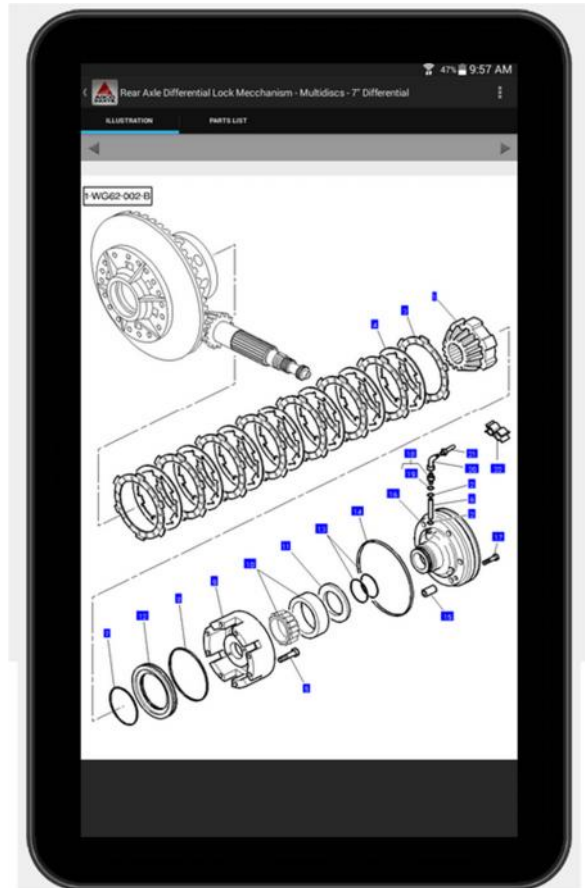

2. GETTING STARTED

A. MINIMUM SYSTEM AND HARDWARE REQUIREMENTS

1. Supported Devices and Operating Systems:

- a. Android operating systems 4.0.1 onwards for both phones and tablets.

2. Other Requirements:

- a. At least 15 MB will be used by the app (More space will be needed to download books for offline use).
- b. A user name and password are required. AGCO will provide to Dealers / Distributors. Dealer / Distributors will provide to their Customers.
- c. An internet connection is required for logging in to the app and to download books (offline use is available after login).

B. DOWNLOAD THE AGCO PARTS TO GO APP AND OBTAIN A LOGIN

1. The app will be available for download in the Google Play Store on your device. An account with Google is required.
2. You can find the app by using the search feature of the store. Use keywords AGCO, Parts and Book to search for the app.
3. Download the app to your device. The icon for the app is shown below.



4. To obtain a login to the AGCO Parts Books To Go app please contact your Dealer / Distributor. Dealers / Distributors should contact their normal AGCO Support Help Desk.

C. LOGGING IN TO THE APP

1. When you first start up the app you will come to the Login screen.

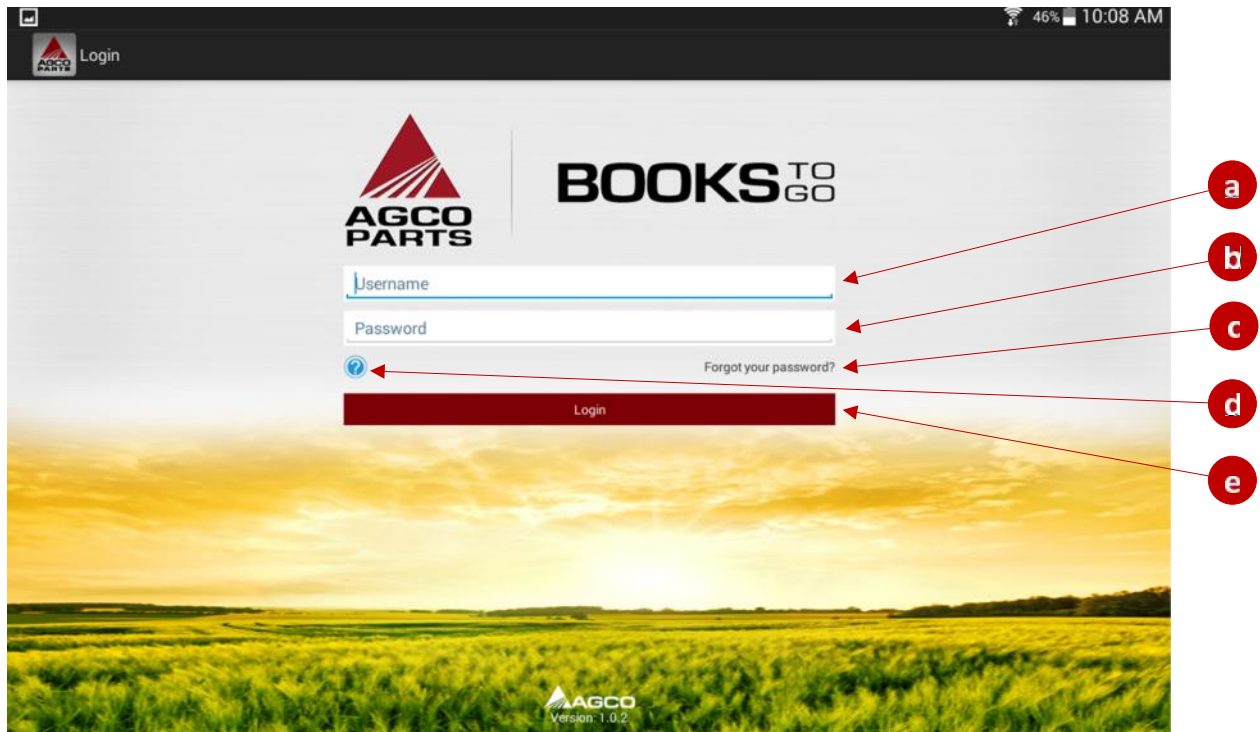

2. Enter your login information.

- a. In this field, you must type your **Username**.
- b. In this field, you must type your **Password**.
- c. If you have **Forgotten your password**, click on this link. You will be required to enter your email address and then click on Reset Password.
- d. If you need assistance logging in, press the “?” to go to the FAQs page. (Note: Your mobile device must have internet service to access FAQs page.)
- e. Once you complete entering your username and password, press this **Login** button to enter the app.

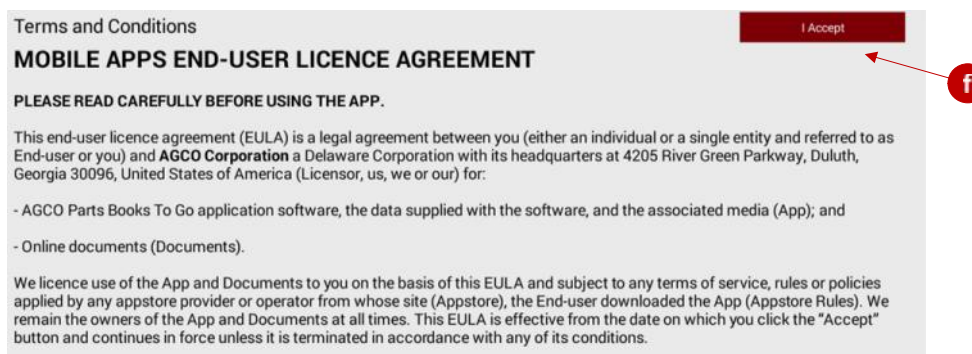

- f. If this is the first time you have logged in you will come to the Terms and Conditions page. Press the “I accept” in the upper right hand corner to accept the Terms and Conditions and continue on to the app.

3. USING THE APP

A. HOME SCREEN

After logging in you will be at the Home Screen.

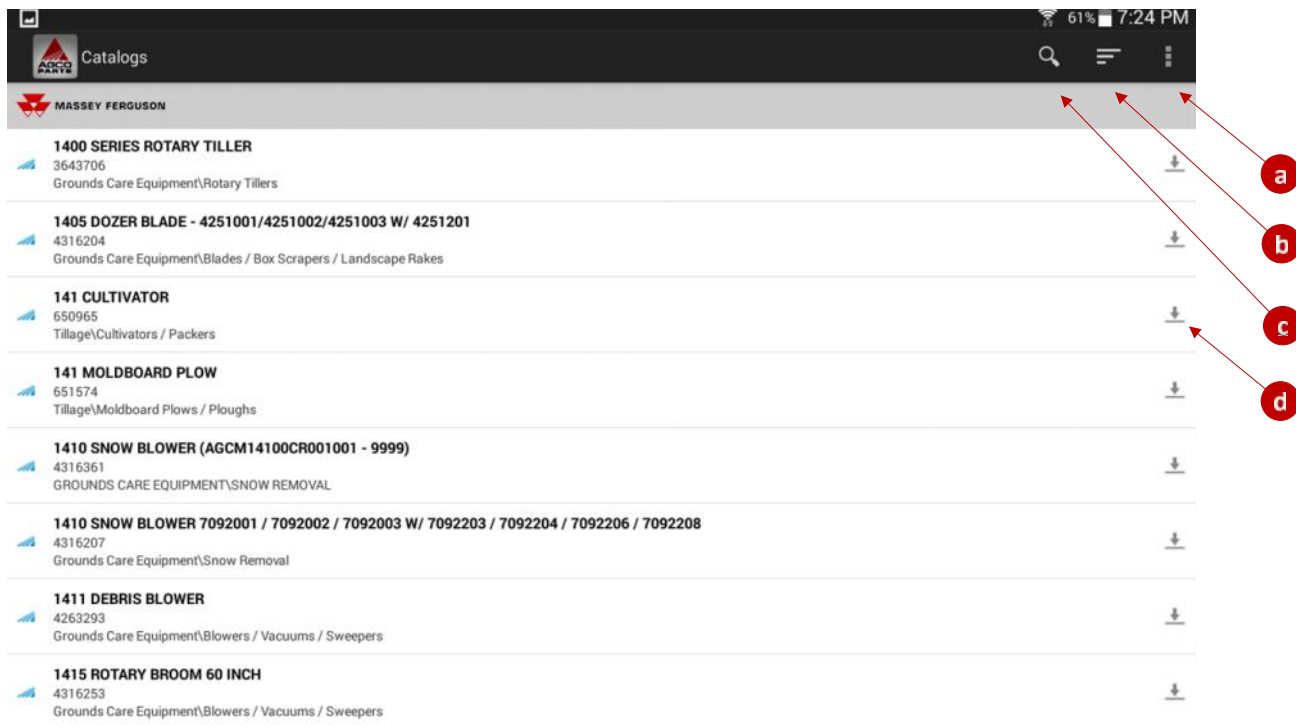

- a. This is the menu button and allows you to move between the **Catalogs / Cart / Settings** screens.
- b. **Configure Search**. This will give you the option to change the search settings to Model / Book Title, Serial Number or Part Number.
- c. **Search bar**. This will bring up a search bar and the keyboard will automatically appear as shown below.
- d. **Download**. Touch to download a book. The progress can be seen in the normal Android status bar. Depending on your device this could be at the top / bottom of the screen.

B. SEARCHING AND SORTING THE CATALOGS FILTER

1. The Search By and Sort by filter menu is available any time you are viewing the list of catalogs.

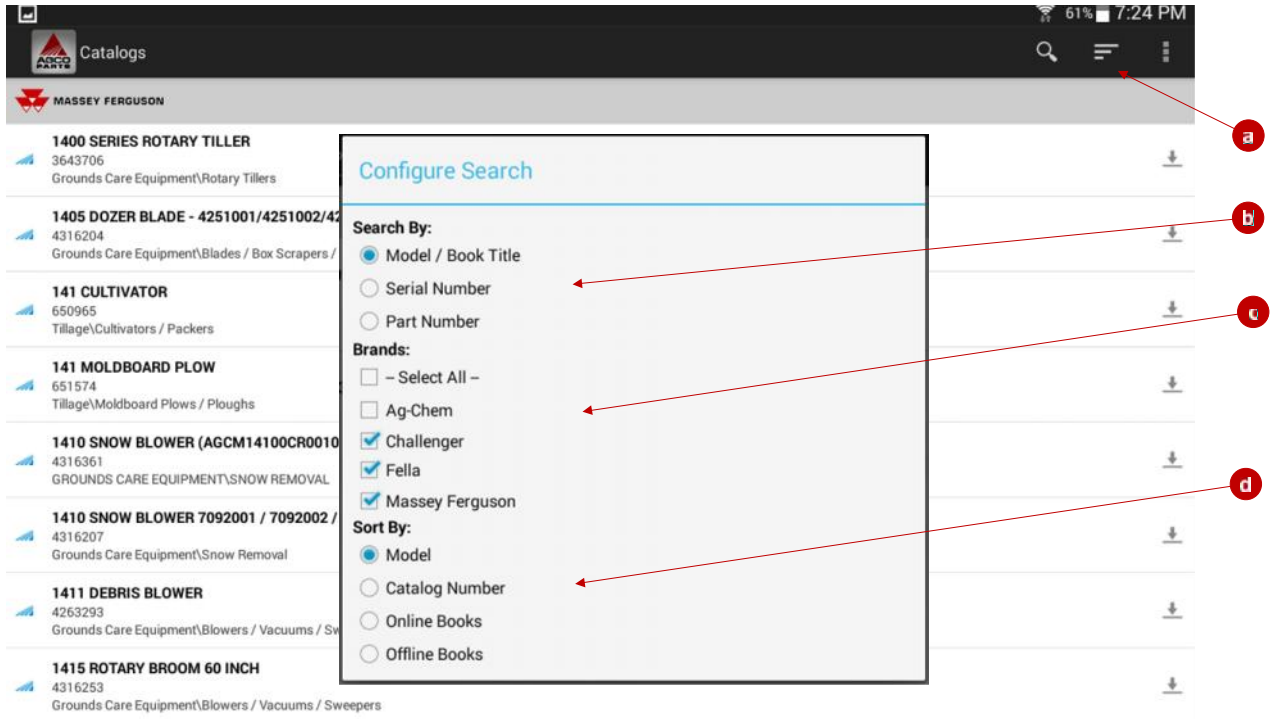

- a. Click on the Filter option to display the menu.
- b. Select the option that you want to search catalogs by: **Model / Book Title**, **Serial Number** (Fendt models only), or **Part Number**.
- c. Further narrow searches by selecting or de-selecting desired **Brands**.
- d. Select the option you want to sort the catalogs by: **Model**, **Catalog Number**, **Online Books**, or **Offline Books**.

C. SEARCHING THE CATALOGS

1. Searching by Model / Book Title:

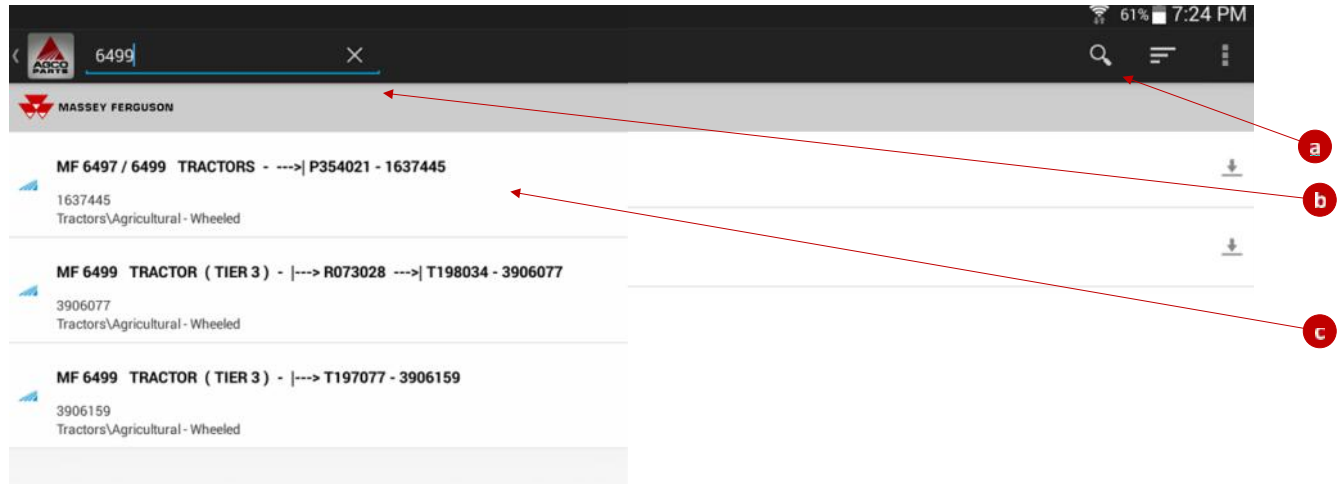

- Click the **Search** icon to start the search feature. The icon will disappear once pressed and a new area for entering a search will appear.
- Enter the **Search Model** to start the search.
- When you are searching via the **Model / Title filter**, entering numbers and letters will cause the catalog to continuously filter out incompatible results until you are left with all the possible matches.

2. Searching by Serial Number (Fendt only):

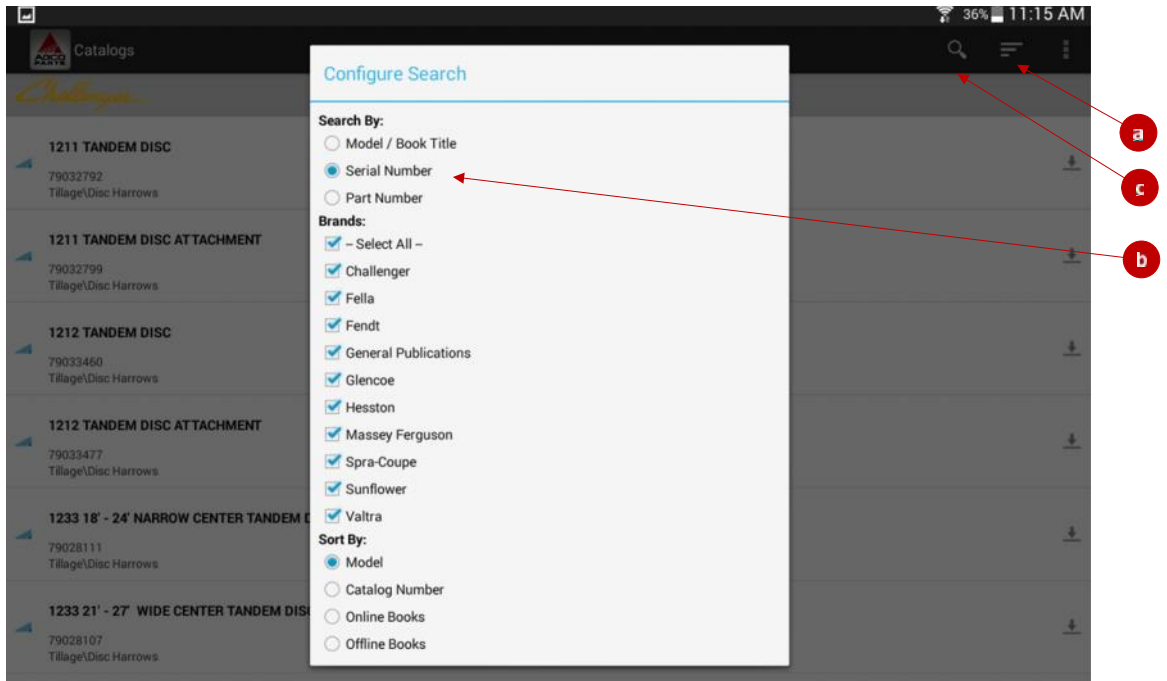

- a. Tap on **Configure Search**.
- b. Change the search to **Serial Number**. Tap anywhere on the screen to remove the window.
- c. Tap on the Search icon to bring up the search bar.

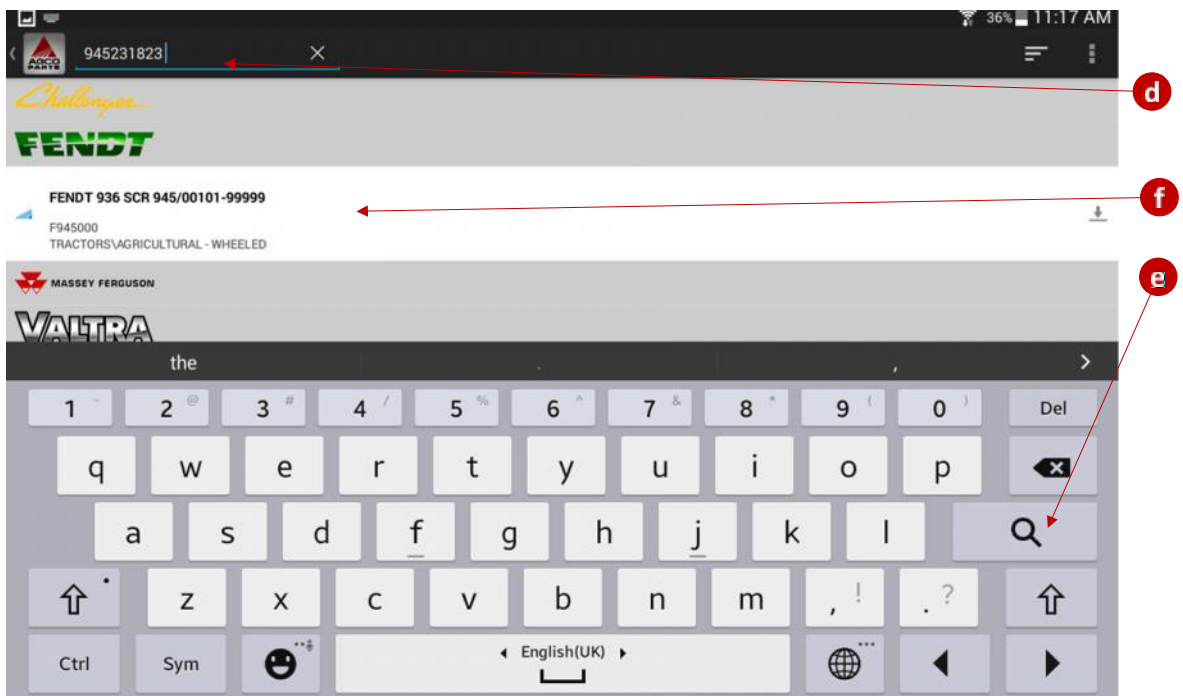

- d. Type in the full Serial Number here.
- e. Press the Search key on the keyboard.
- f. Tap on the book name to enter the book.

3. Searching by Part Number:

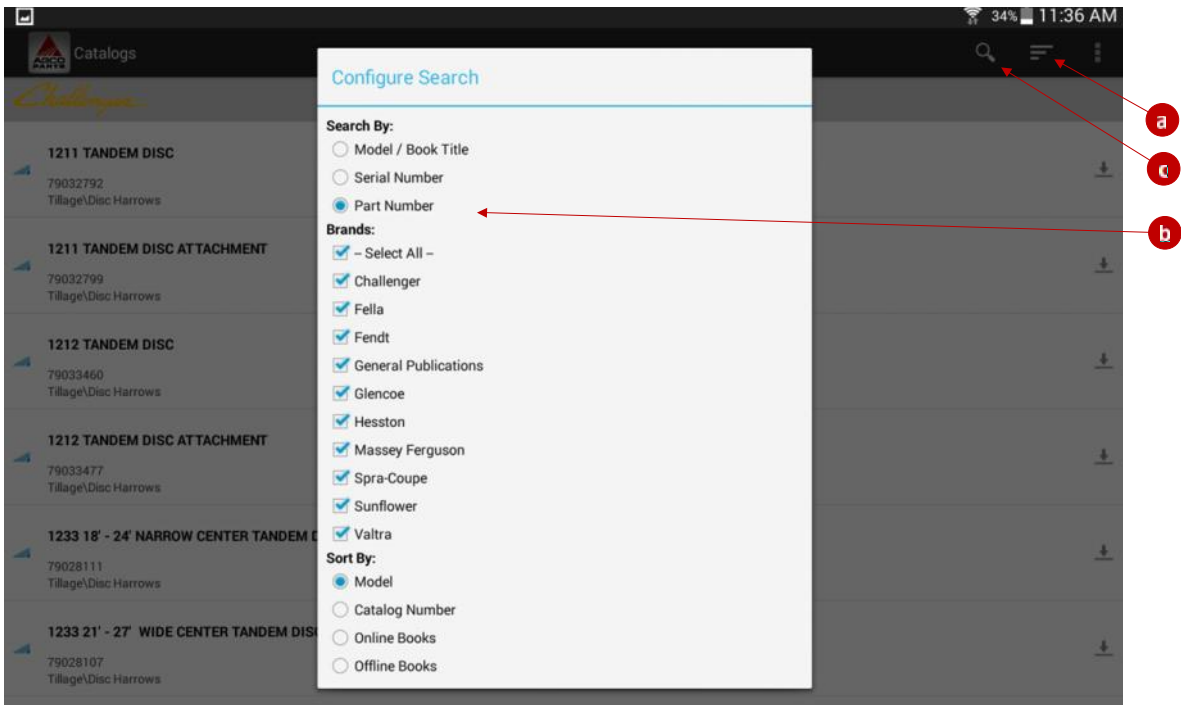

- a. Tap on Configure Search.
- b. Change the search to 'Part Number'. Tap anywhere on the screen to remove the window.
- c. Tap on the Search icon to bring up the search bar.

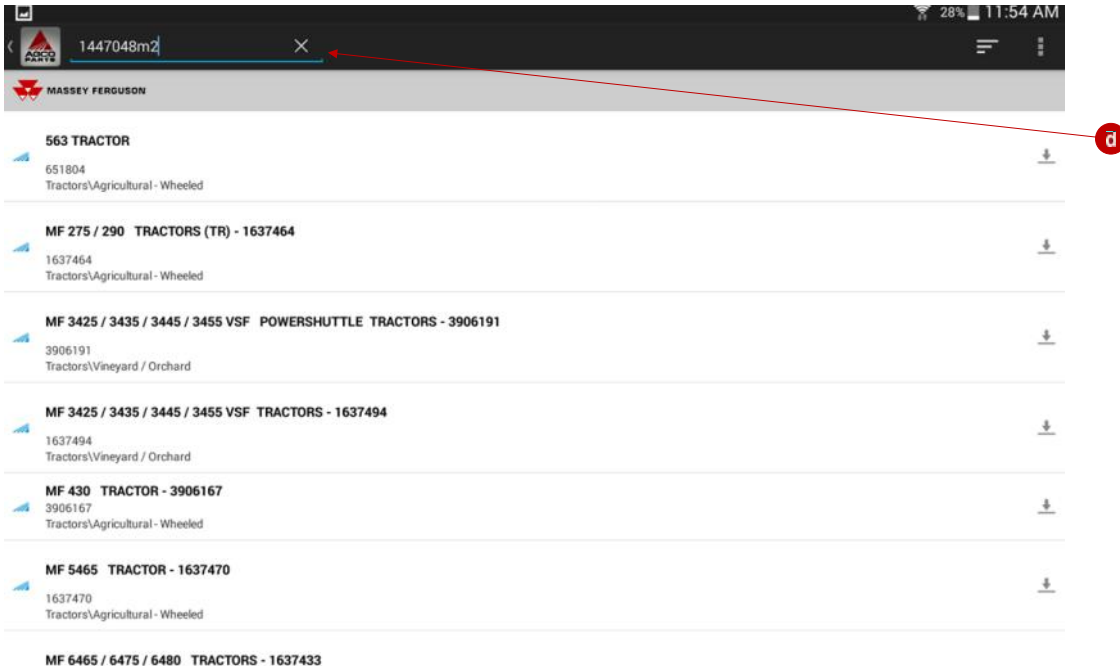

- d. Enter a part number and click on search and the books that contain this part number will appear.

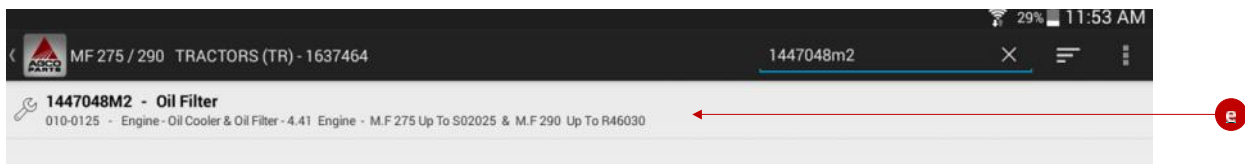

- e. Clicking on the catalog will bring up the search of the part number within that book.

D. VIEWING CATALOG CONTENT

1. When you select a catalog to view you will be shown the catalog's content:

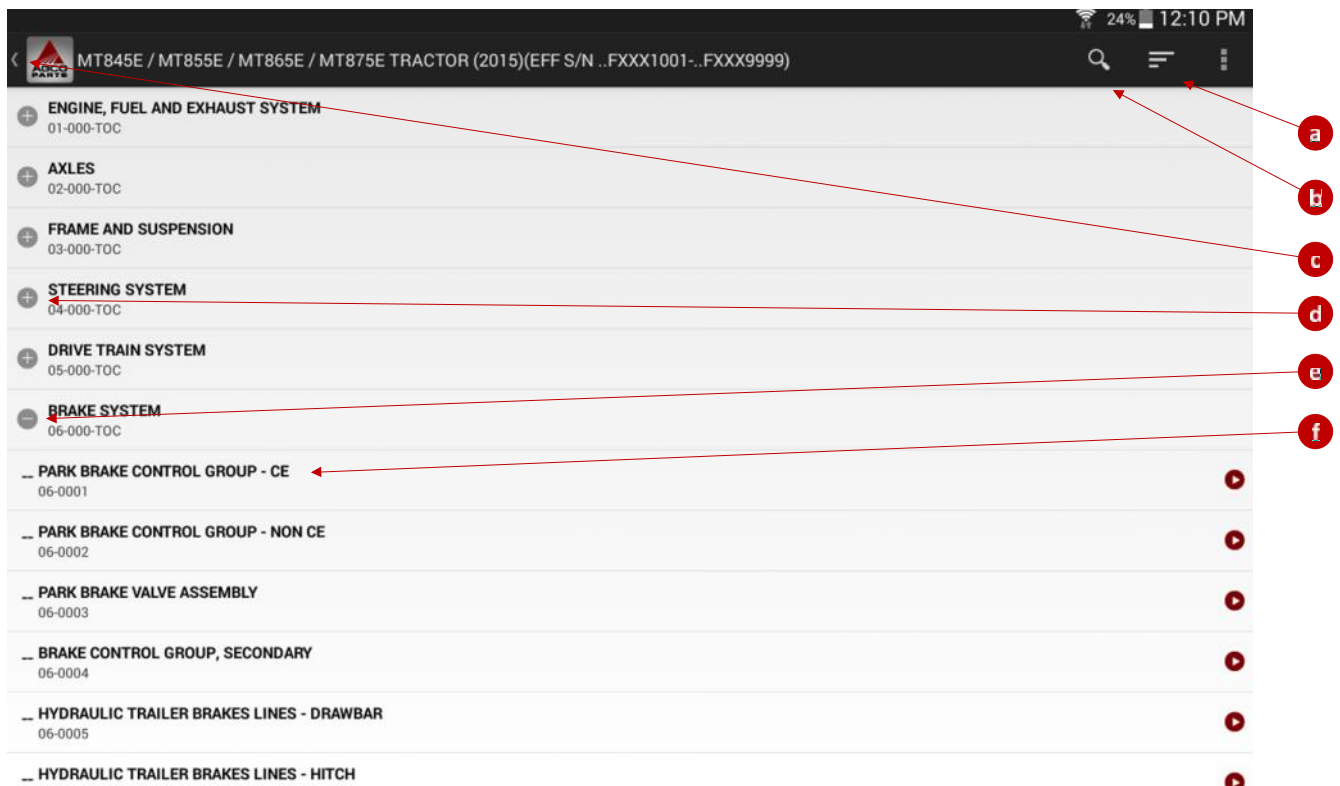

- a. **Configure Search:** The filter icon allows for more specific searches.
- b. **Search Icon:** This brings up the search bar and the configured search (a) will be performed on the book.
- c. **Home:** Exits the book and takes you back to the home screen. Note that this is different from the back button which will take you back one step.
- d. **Expand List:** Touch the title or the Plus (+) icon to expand the contents of the section.
- e. **Collapse List:** Touch the title or the Minus (-) icon to collapse the contents of the section.
- f. **Illustration:** Touch the page title to go to the illustration.

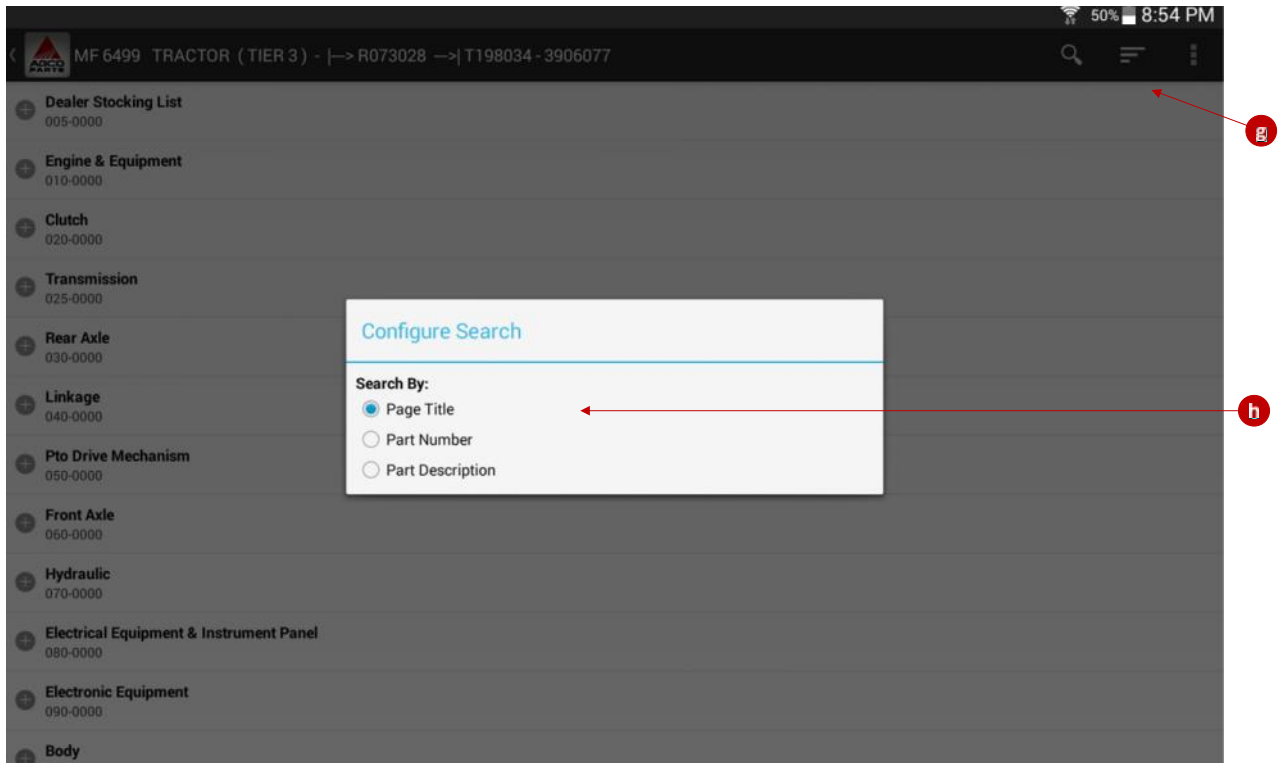

- g. The Configure Search configure search option allows searches by:
- h. Page Title, Part Number, Part Description.

After selecting the search type, you will need to click on the Search icon  to enter the search criteria.

2. Illustration Display :

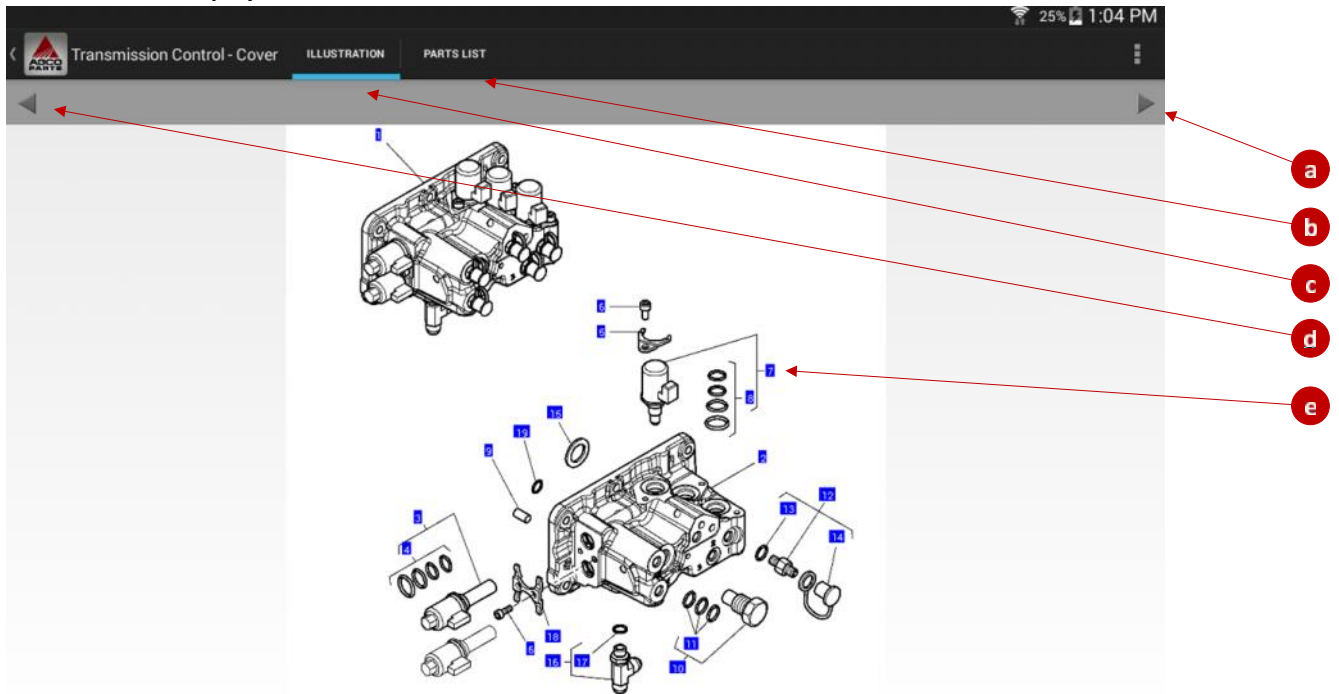

This area displays the page illustration of the catalog with a diagram with call out numbers on it (numbers in blue rectangles). You can zoom into the illustration by pinching with two fingers. If you touch any call out number it will open a window which includes detail information about the part. See below for more information.

- a. Press the forward arrow to go to the next page of the catalog. If the icon is missing then you are on the last page of the book.
- b. Press the Parts List tab to switch to the Parts List Display.
- c. Press the Illustration tab to switch to the Illustration. The blue highlight bar shows that the illustration tab is active.
- d. Press the back arrow to go to the previous page of the catalog. If the icon is missing then you are on the first page of the book.
- e. Press any of the blue call out numbers to get more information on the part illustrated.

3. Part Detail Window:

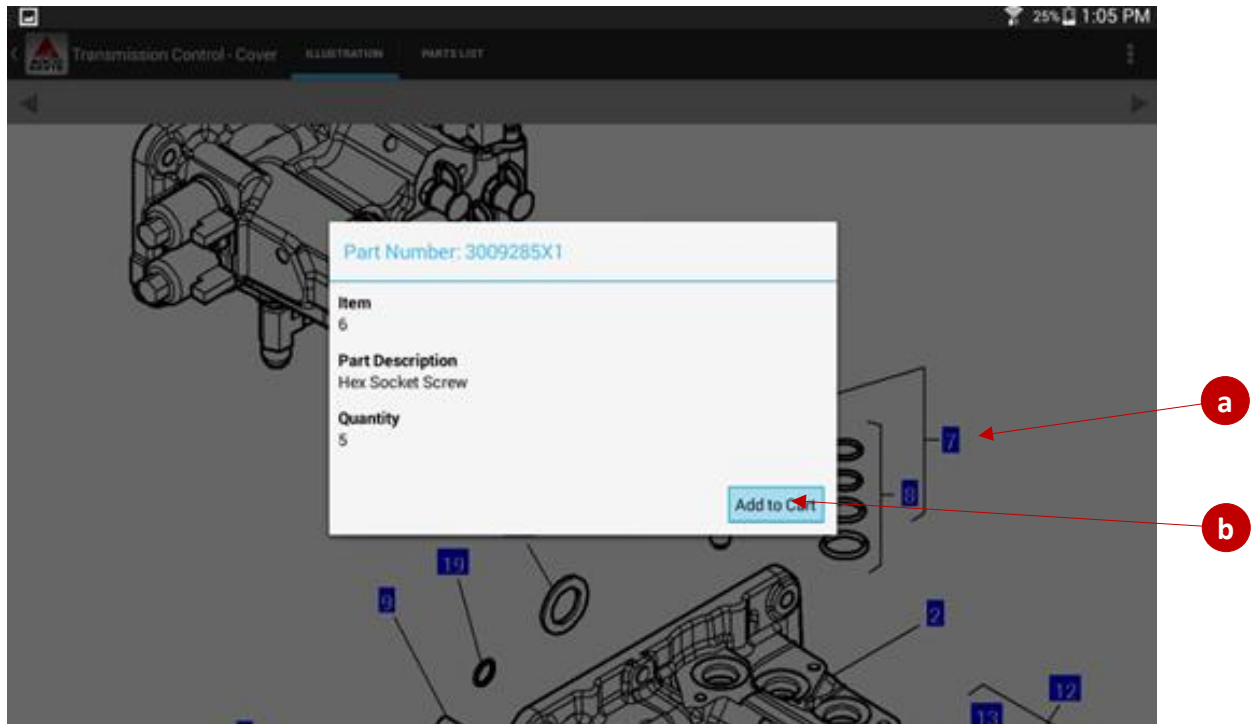

- a. The detail information window will be displayed when you touch a call out number.
- b. Press the **Add to Cart** button to add the item to your cart. See section *E. Using the Shopping Cart* for more information.

4. Parts List Display:

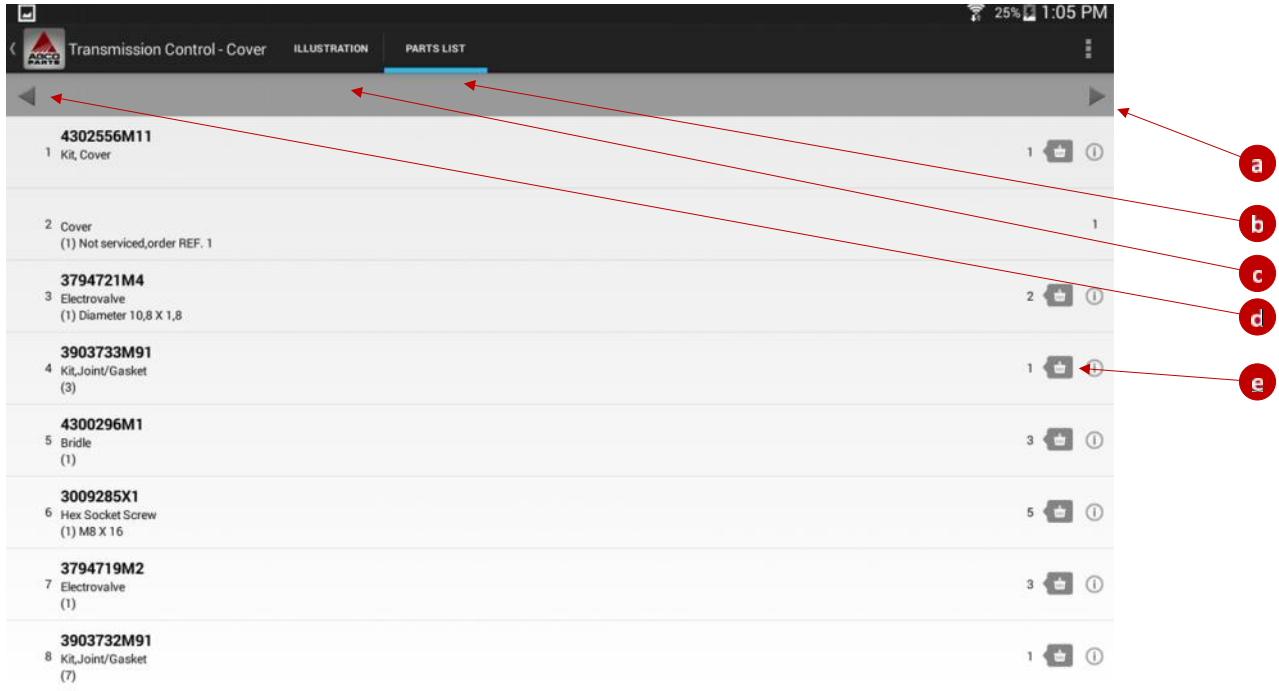

- Press the forward arrow to go to the next page of the catalog. If the icon is missing then you are on the last page of the book.
- The blue highlight bar shows that the parts list is active.
- Tap to show the illustration for the parts list displayed.
- Press the back arrow to go to the previous page of the catalog. If the icon is missing then you are on the first page of the book.
- Press to add the part to the cart. Each line shown has the following information:
 - Part number.
 - Part Description.
 - Technical Specifications.
 - Quantity.

E. USING THE SHOPPING CART

1. After pressing the Add to Cart Button the following window will display:

The screenshot shows a mobile application window titled "Add to Cart". The window contains the following elements:

- Part Number:** 3009285X1
- Quantity:** 5, with minus (-) and plus (+) buttons for adjustment.
- Part Description:** Hex Socket Screw
- Comments:** (1) M8 X 16
- Buttons:** A blue "Add to Cart" button at the bottom.

Red circles labeled a through f point to specific elements:

- a: Top right corner of the window.
- b: The quantity field.
- c: The minus (-) button.
- d: The plus (+) button.
- e: The comments field.
- f: The "Add to Cart" button.

- a. Touch anywhere outside the window to cancel and keep the part from being added to your cart.
- b. Quantity can be directly entered using the numeric keypad by touching the quantity figure.
- c. You can decrease the quantity by 1.
- d. You can increase the quantity by 1.
- e. Comments can be edited if required.
- f. Click on **Add to Cart** to add the part to the cart.

2. Shopping Cart Display:

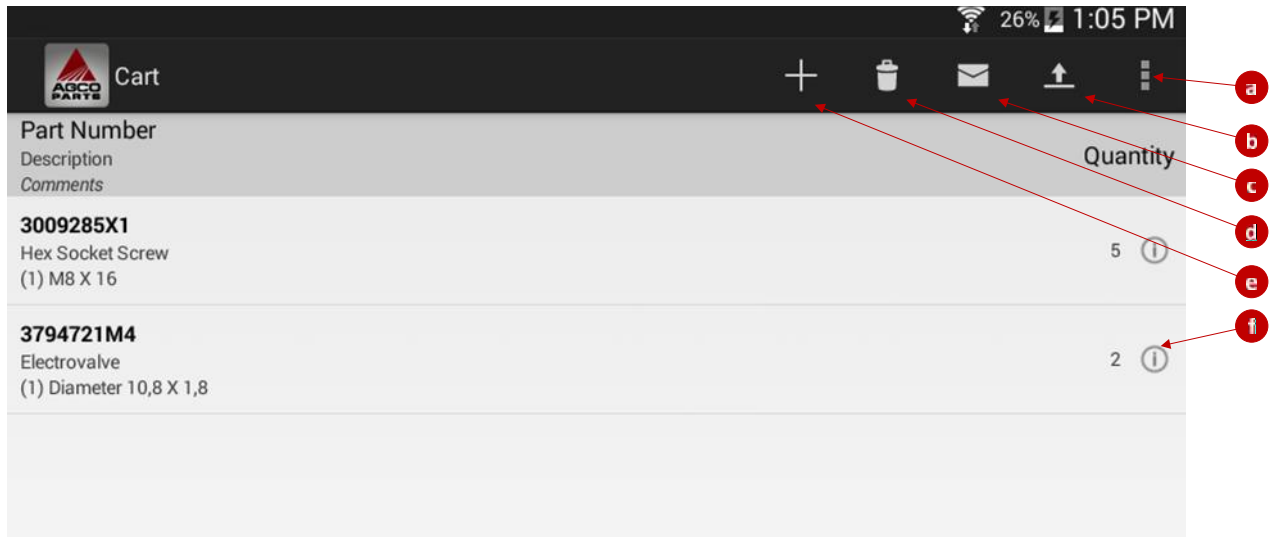

- The Shopping cart is displayed by clicking on the menu button and selecting Cart.
- Transfer cart to Authorized Dealer / Distributor. (Only if your dealer has enabled the Dealer Business System Integration. See section **F. Dealer Business System**)
- Email cart. An email will be generated with the part numbers / quantities on the email. You need to enter the email address and click send.
- To remove the entire list of parts from the cart, click on the trash can icon.
- If you want to add parts manually to the cart, click this button and enter the details.
- To edit the item in your cart press the "Information" icon. This will open an "Add to Cart" window where you can change the quantity or comments for the item. You are also able to remove the line from the cart.

F. DEALER BUSINESS SYSTEM / DEALER MANAGEMENT SYSTEM

As an optional service your Dealership may opt to implement a Dealer Business System (DBS or DMS) integration with Parts Books To Go. This integration provides Dealers the ability to show the following supplemental information in the app.

For Customers:

- a. Dealer Selling Price
- b. OH (On-Hand) Inventory

For Dealers:

- c. Recommended Retail Price
- d. Dealer Net Price
- e. OH Inventory
- f. Dealer Group Stock
- g. Dealer Bin Location

The image displays two screenshots of the 'Add to Cart' interface. The left screenshot shows the customer view, and the right screenshot shows the dealer view. Red arrows point from callouts 'a' through 'g' to specific data points in both views.

Field	Customer View Value	Dealer View Value	Callout
Part Number	V835076137	V835076137	
Quantity	1	1	
Part Description	Engine	Engine	
Comments	Replace and repair. Old not interchangeable with new V835061285	Replace and repair. Old not interchangeable with new V835061285	
Recommended Retail Price	72675.00	72675.00	c
Dealer Net Price		39370.00	d
OH Inventory	2	2	e
Dealer Group Stock		3	f
Bin Location		ENGINE	g

These details can be seen on screen when adding parts to the cart. For more information on the DBS integration for those interested, please contact your AGCO Dealer Support Help Desk.

G. CHANGING THE APP SETTINGS

1. When you press the menu button (a) and select Settings the following screen is shown:

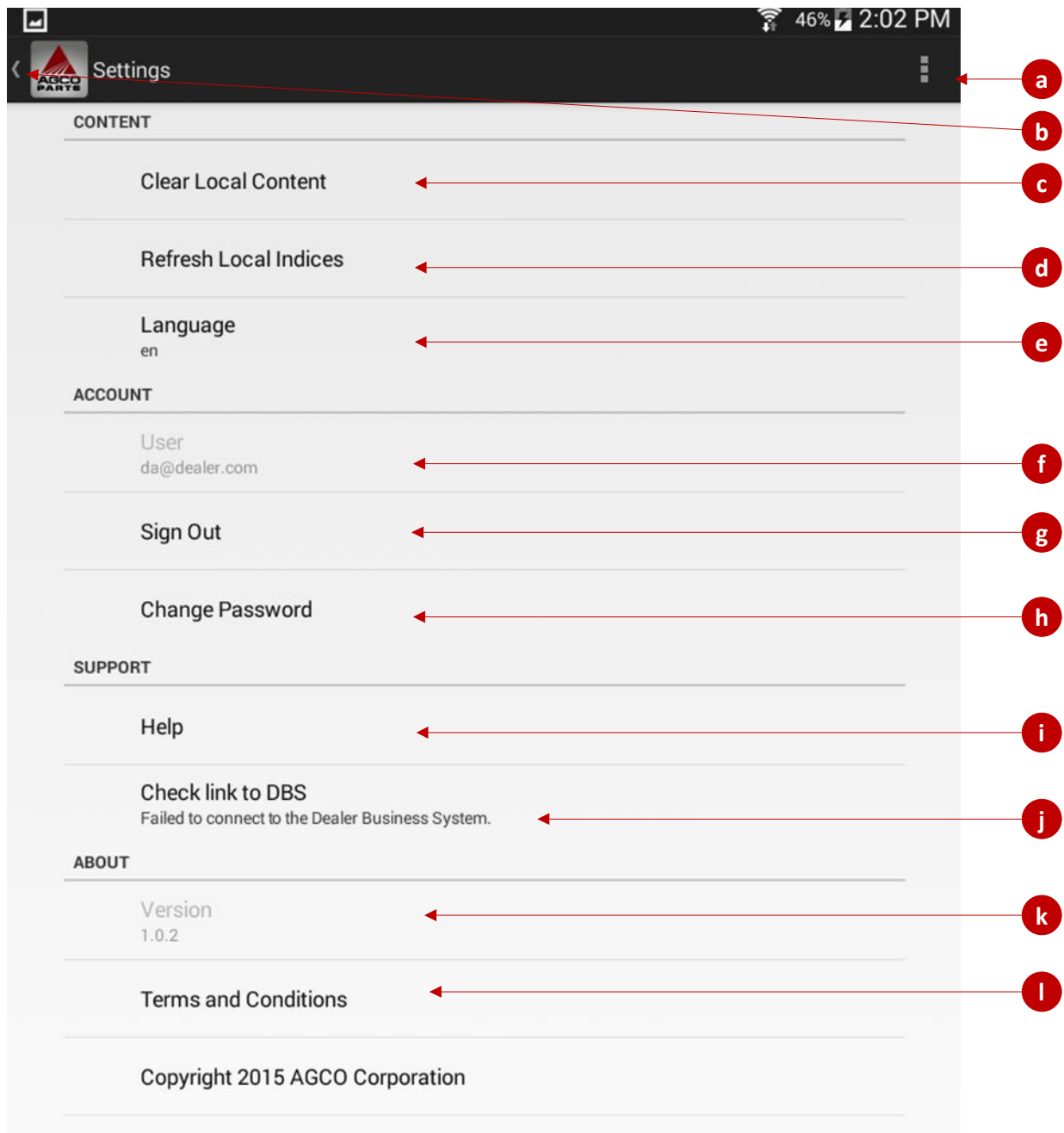

- Menu Button.** Press and select Settings to display the settings screen.
- Home.** Press to go back to the initial home page showing the catalogs of books.
- Clear Local Content:** Press "Clear Local Content" to clear all the catalogs that have been downloaded to your device.
- Refresh Local Indices:** Press "Refresh Local Indices" to refresh data without deleting all downloaded books.
- Select Language:** Press "Language" to switch the default language that is displayed.
- User ID:** This is the user ID that has logged in to the app.
- Sign Out:** Press "Sign Out" to log off from your account (this will take you back to the login screen).

- h. **Change Password:** Press here to change your password.
- i. **Help Button:** When you press “Help” your browser will open and take you to our Help web site. (Note: Your device must be online to access the Help site.)
- j. **Check Link to DBS:** This will show if there is an active link to the Dealer Business System. Press to recheck status. (Note: This will only apply if Dealer has implemented the DBS Interface.)
- k. **Current Version of app:** This is the version of the app that is on your device.
- l. **Terms and Conditions:** Pressing here will display the Terms and Conditions of the app.

H. FREQUENTLY ASKED QUESTIONS

- 1. Can I use the app if I am offline?**
 - a. Yes – but you have to already be logged on. You may not login without being online.
- 2. How long will downloaded data stay on my device?**
 - a. Downloaded data will stay on your device for 7 days. After 7 days you must re-download the data to keep the information up to date and valid.
- 3. How much data am I able to download each week?**
 - a. The data download limit is 100MB or around 20 books.
- 4. Do I have to login every time I use the app?**
 - a. No – As long as you do not logout yourself or completely close out the app you will remain logged on for the next 7 days. If you do not use the app for 7 or more days you will then automatically be logged out and be forced to re-enter your credentials the next time you use the app.
- 5. How many users can a single dealer have?**
 - a. At this time, each dealer may have a maximum of 50 users. If this starts to cause you a problem please contact us.
- 6. What will occur if I do not use the app for a long period of time?**
 - a. If a user does not use their account for 120 days or more they will get disabled. Once this happens you must contact either your Dealer (for Customers) or AGCO Dealer Support Help Desk (for Dealers / Distributors) to get your account re-enabled.
- 7. For Dealers – How do I get implemented in a DBS Integration with the app?**
 - a. Contact your AGCO Dealer Support Help Desk and they will provide you a document describing how to get integrated.