

1940-96

Agricultural Tractors

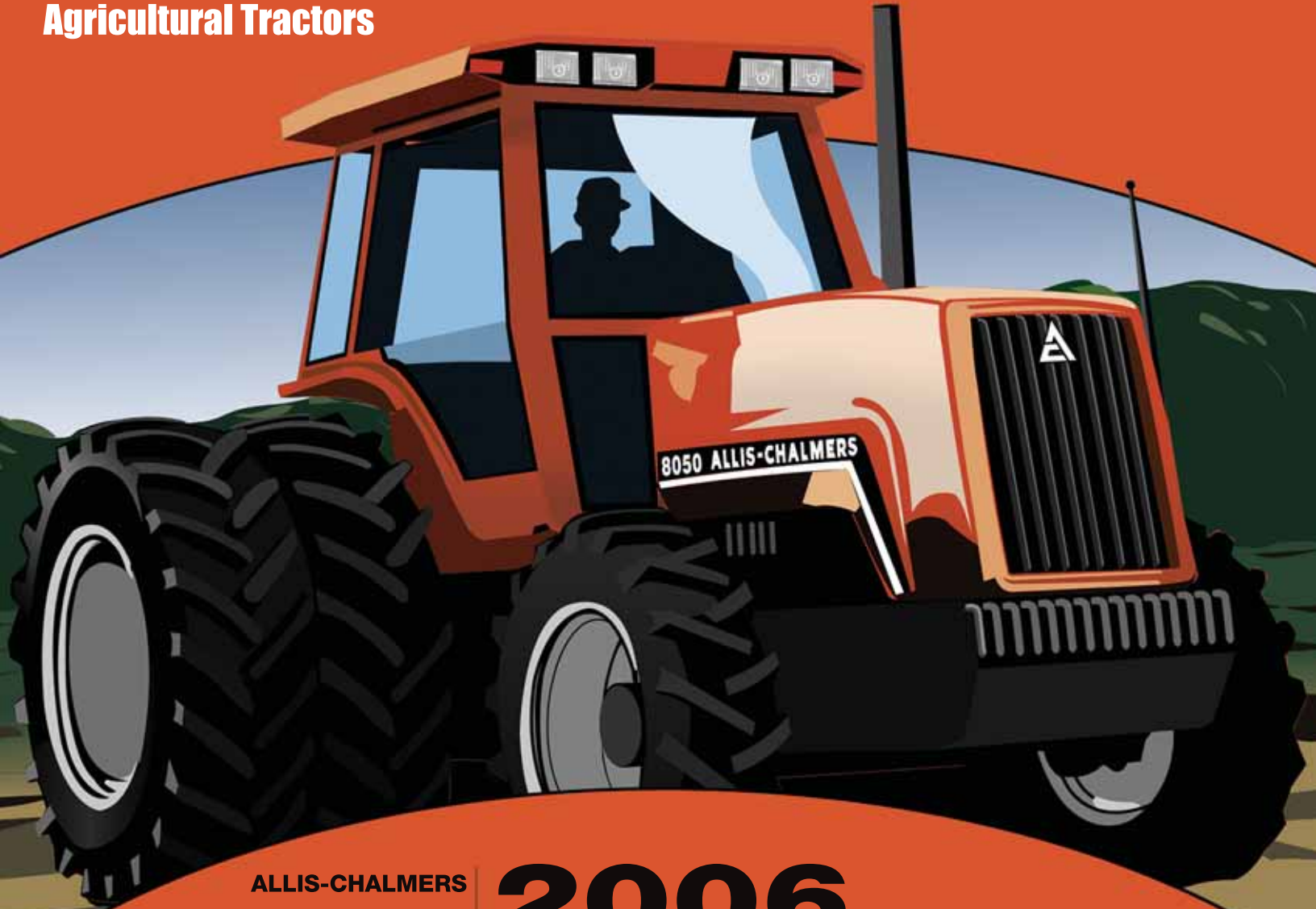

ALLIS-CHALMERS
AGCO-ALLIS
DEUTZ-ALLIS
DEUTZ-FAHR

2006

PARTS & MERCHANDISE CATALOG





2006 AGCO® HERITAGE® PARTS AND MERCHANDISE CATALOG

Agricultural Tractors 1940-1996

Allis-Chalmers™, AGCO®-Allis, Deutz-Allis, Deutz-Fahr



Cover Illustration

The Allis-Chalmers™ 8050 tractor was one of four A-C 8000 Series tractors introduced in early 1982. Rated at just over 152 hp and featuring front-wheel assist, the tractor included a roomy cab with numerous comfort features. A sales brochure for the 8000 Series hailed the line as being “Better by Design.” Today, you’ll still find thousands of Allis-Chalmers™ tractors in service across North America and the world, cherished by active farmers and collectors alike. AGCO® Heritage® parts bring original equipment quality that farmers and collectors will appreciate, at attractive prices, and backed by a full-year warranty.

- Illustration by Elmer Meider

Allis-Chalmers™, Ferguson™, SisuDiesel™ and White™ are trademarks, and AGCO®, Cockshutt®, Epsilon®, Gleaner®, Heritage®, Massey Ferguson®, Minneapolis-Moline®, New Idea®, Oliver®, Solutions® and the White Farm Equipment (WFE®) logotype are registered trademarks, of AGCO Corporation, Duluth, GA, USA. Challenger® is a registered trademark of, and is used worldwide under license from, Caterpillar Inc., Peoria, IL, USA.

3M® is a registered trademark of 3M Corporation, St. Paul, MN, USA. Bosch® is a registered trademark of Robert Bosch GMBH, Gerlingen, Federal Republic of Germany. Caterpillar is a registered trademark of Caterpillar Inc., Peoria, IL, USA. Case® and Case IH® are registered trademarks of CNH America LLC, Racine, WI, USA. Cummins® is a registered trademark of Cummins Engine Company, Columbus, OH, USA. Delco-Remy® is a registered trademark of General Motors Corporation, Detroit, MI, USA. Denso® is a registered trademark of Denso Corporation, Showa-cho Kariya-city, Aichi-pref., Japan. Deutz® is a registered trademark of Klockner-Humboldt-Deutz Corporation (KHD), Koln, Federal Republic of Germany. Deutz-Fahr® is a registered trademark of Same Deutz-Fahr S.p.A., Treviglio, Bergamo, Italy. Ford® and Motorcraft® are registered trademarks of Ford Motor Company, Dearborn, MI, USA. GMC® is a registered trademark of General Motors Corporation, Detroit, MI, USA. International® is a registered trademark of International Truck Intellectual Property Corporation, Warrenville, IL, USA. John Deere® is a registered trademark of Deere & Company, Moline, IL, USA. Kenworth® is a registered trademark of PACCAR Inc. (aka Kenworth Truck Company), Bellevue, WA, USA. Lucas® is a registered trademark of Lucas Industries Ltd., West Midlands, UK. Marvel-Schebler® is a registered trademark of Raymond Beutel, Lockport, NY, USA. Niehoff® is a registered trademark of BWD Automotive Corporation, Branford, CT, USA. Perkins® is a registered trademark of Perkins Holdings Ltd., Peterborough, England. Zenith® is a registered trademark of Zenith Electronics Corporation, Lincolnshire, IL, USA.

While AGCO has made every effort to catalog this information correctly, the possibility for error exists. Please verify each listing with your parts book or service manual.

CONTENTS

INTRODUCTION	2-3
RESTORE YOUR WORKING TRACTOR TO LIKE-NEW CONDITION	4-5
AGCO OFFICIALLY LICENSED MERCHANDISE	6-9
Die Cast Toys and Pedal Tractors, Replicas and Collector Series, Resin and Pewter Collectibles, Apparel and Caps, Specialty Items	
INDEX	10-11
MACHINE INFORMATION	12-28
A-C Tractor & Serial Number Location Guide, Operators and Service Manuals, Parts Books	
UNIVERSAL ACCESSORIES	29
Quick Hitches, Toolbox	
AESTHETICS	29-58
Decals, Decal Kits and Emblems, Paint Application Guide, Cab Kits, Floor Mats, Upholstery, Headliners, Wipers, Glass, Seats, Knobs, Gauges, Latches, Handles	
ENGINE	59-107
Liners, Pistons and Components, Complete Overhaul Kits, Block Kits, Engine Belts	
LUBRICATION	108-109
Dipsticks, Oil Fill Caps, Gaskets, Hose, Oil Pump Assemblies	
ELECTRICAL	110-125
Distributor Ignition Components, Spark Plugs, Starters and Alternators, Cross-Reference Guide, Solenoids, Regulators, Switches	
LIGHTING	126
Bulbs, Assemblies	
FILTERS	127-130
Allis-Chalmers™ Brand, Heritage® Filters	
FUEL COMPONENTS	131-134
Carburetors, Fuel Pumps, Glass Fuel Bowls, Fuel Injection Components, Lift Pumps, Fuel Caps	
EXHAUST AND INTAKE	134-141
Manifolds and Gaskets, Mufflers and Supports, Universal Exhaust Accessories, Air Cleaner Components, Precleaners	
COOLING	142-145
Radiators and Hoses, Gaskets, Sending Units, Thermostats, Water Pumps	
FRONT AXLE AND STEERING	146-149
Spindles, Tie-Rod Ends, Steering Arms, Power Steering Components, Wheel Bearing Kits	
3-PT. HITCH AND PTO	149-150
Lift Arm Components, Driveline, PTO Bearings, Seals Components	
BRAKES	151
Discs, Seals, Master Cylinders	
CLUTCH	152-155
Pressure Plate and Disc Sets, Assemblies, Bearings, Discs	
TRANSMISSION COMPONENTS	156
Bearings	
REAR AXLE	157
Bearings, Seals	
HYDRAULICS	158
Pump Assemblies, Control Units	
FROM THE ALLIS-CHALMERS™ PARTS MARKETING ARCHIVES	159-161
A look through the Allis-Chalmers™ Parts photo files from the 1970s reveals certain themes still apply.	

INTRODUCTION



Heritage® Parts carry distinctive packaging and labels. Heritage® parts are backed by a full year warranty for quality and performance.

Heritage® parts are original-equipment-quality parts for older equipment now part of the AGCO family of equipment brands. An AGCO® Heritage® part carries its own packaging and can be sold by any U.S. or Canadian AGCO dealer, including Massey Ferguson®, AGCO® tractor and Challenger® dealers.

AGCO® Heritage® parts offer the following benefits:

- O.E. approval for the original equipment
- Attractively priced
- Backed by a full year warranty
- Stocked in AGCO parts distribution centers across U.S. and Canada
- Available from all AGCO dealers

In addition, dealers actively promoting Heritage® parts will have indoor and outdoor signage highlighting this line.



Dealers carrying Heritage® parts can promote this fact with outdoor and indoor signage.



This catalog overviews O.E.-quality replacement parts available for Allis-Chalmers™, AGCO®-Allis, Deutz-Allis and Deutz-Fahr tractors, manufactured from 1940 through 1996. (A handful of parts are also included for A-C cotton harvesting equipment, as well as for tractors manufactured in the 1930s.) It is intended to help dealers and customers alike identify Heritage® O.E.-approved parts currently available from AGCO Parts.

If you do not find the part you need, it may still be available:

- This catalog references fast-moving Heritage® parts only. Not included are thousands of additional parts also available from AGCO Parts for these tractors.
- The Heritage® parts line continues to grow daily.
- The part you're looking for could still be available from AGCO under an O.E.M. part number.

HOW TO ORDER

Any AGCO dealer can order a Heritage® part from AGCO Parts. Heritage® parts are stocked in U.S. and Canadian parts distribution centers for fast, convenient availability. Most Heritage® part numbers for A-C, AGCO®-Allis, Deutz-Allis and Deutz-Fahr applications end with the letter "V", although there are exceptions.

HOW TO USE THIS CATALOG

The catalog is divided into major sections based on the tractor component area (for example, engine, cooling and transmission).

Individual sections are usually organized by MUO (Machine Used On) information, from late to early models. Photos and illustrations are added throughout.

In addition, the Machine Information section includes a valuable serial number location guide with A-C tractor models and the years they were built.

Be sure to take special note of the Allis-Chalmers™ brand product, including filters and gauges, for early A-C tractors.

The AGCO® Heritage® parts line was introduced 10 years ago to make O.E.-quality parts available for sale by all AGCO dealers, U.S. and Canada.

Ultimately, by expanding the Heritage® parts line, farmers and collectors who want O.E. parts quality should be able to more easily find a dealer who can fully support their older equipment.

RESTORE YOUR WORKING TRACTOR TO LIKE-NEW CONDITION



Photo courtesy of Norman Swinford

Keeping your Allis-Chalmers™ or AGCO®-Allis tractor in top condition isn't simply a matter of pride. Improve its performance with an update using Heritage® parts.



Manuals

Pg 23-28

ALLIS-CHALMERS

Decals

Pg 29-47

Paint

Pg 48-50

Interior Cab

Pg 51-57

Engine

Overhaul Kits

Pg 95-99

Electrical

Starters & Alternators

Pg 112-123

Filters

Pg 127-130

Mufflers

Pg 136-139

Front Axle

Pg 147-148

Clutch Sets

Pg 152-154

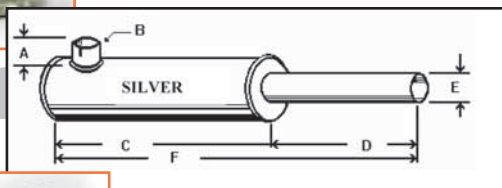
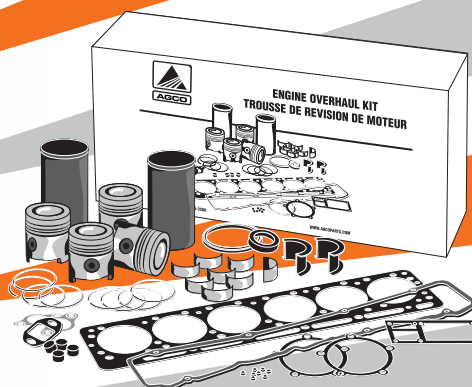

Die Cast Pedal Tractors

Scale Models



A-C WD45
FT-0680

AGCO® RT150
FT-0703



Plastic Pedal Trailer
FT-0671



- Sized for children 3-10 years old
- Rubber tires, pedals, plastic seat and throttle
- A trailer completes the ensemble
- Some assembly required

Throw Blanket

A-C Vintage B, WC, WD, WD45
Streff Advertising
68"x54"
100% woven cotton
AG04-902AC



Mailbox

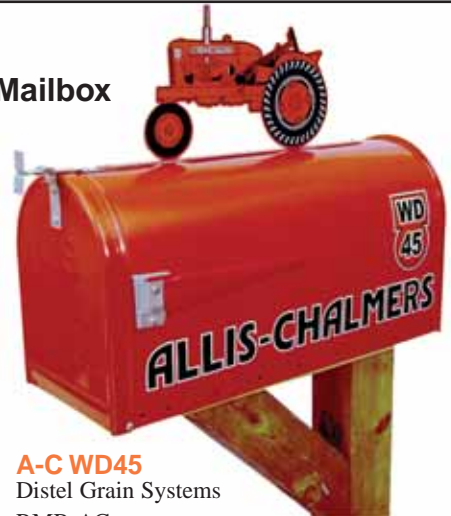

A-C WD45
Distel Grain Systems
RMB-AC

Resin Figure

Boy Holding A-C Flag
Spec Cast
30" H
SCT801



Buckle
Spec Cast



Pewter w/ Enamel
SC03064

1:64 Die Cast



All-American A-C, on Kenworth Truck
Spec Cast
SC32018

1:12 Die Cast



A-C Model WC Steel Wheel
Franklin Mint
B11E100



A-C Model WC
Franklin Mint
FM-0001



A-C All-Crop Harvester
Franklin Mint
FM-0003

Allis-Chalmers™ and AGCO® Tractor Licensed Merchandise

1:16 Die Cast



A-C Model C
Scale Models
FT-0498



A-C Model G w/ Plow
Scale Models
FT-0404



A-C Model D14 Gas Wide Front
Spec Cast
SCT240



A-C Model D15 Gas Narrow Front
Spec Cast
SCT235

NEW!



A-C Model D15 Gas Wide Front
Spec Cast
SCT255



A-C Model 185
Scale Models
FT-0698



A-C Model H-3 Crawler Gas w/ Blade
Spec Cast
SCT236

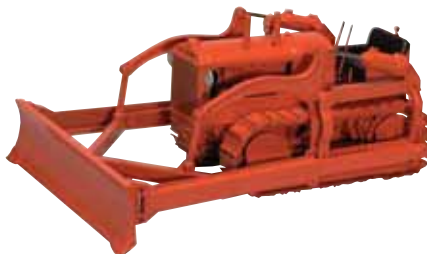

A-C Model KO Crawler Diesel w/ Blade
Spec Cast
SCT237



AGCO® Model DT240A
Scale Models
FT-0704

1:16 Resin



A-C 60 Combine
Spec Cast
SCT253

1:24 Die Cast



Gleaner® Combine
Scale Models
Die cast body; plastic cropheads, spout and tires
FT-0641

1:25 Die Cast



A-C 1932 Ford Pickup
Spec Cast
SC26083

Adult T-Shirts

NEW!



A-C Worn Logo
The Jym Bag Co.
S03322



AGCO® Tractor Word
The Jym Bag Co.
S03099



AGCO® DT240A
The Jym Bag Co.
S03070

Many other styles available.

Youth T-Shirts



Someday Big AGCO® Tractor
The Jym Bag Co.
S02316

AGCO® Owner in Training
The Jym Bag Co.
S02432

Adjustable Caps

Available in a variety of colors and styles.



A-C Logo
The Jym Bag Co.
Direct Embroidery
ES1618



AGCO® Tractor

- American Identity
- Antonio Moreau (Canada)
- Cary Francis
- The Jym Bag Co.

NEW! Flags, Pennants and Counter Stools



A-C Nylon Flag, one sided

Streff Advertising

3'H x 5'W

AG04-201

Also Available:

AGCO® Tractor Flag AG04-206

AGCO® Tractor Pennant (60"L) AG04-222

AGCO® Tractor Counter Stool (30"H) AG04-115

Pewter Watch Fobs, Key Chains



Watch fob comes with leather strap.

A-C (Top) Watch Fob

LAAW0019

Also Available: Key Chain

LAAK0021

A-C (Bottom) Watch Fob

Lone Tree Creek, LLC

LAAW0021

Also Available: Key Chain

LAAW0012

Collectible Jigsaw Puzzle

A-C Vintage Montage

Putt-Putt Puzzles

513 pieces, 15"x12"

ACO4-1



Art Print



Delivering to the Farmer Since 1953

by Dorothea Paul

Allis-Chalmers™ and AGCO® Tractor Licensed Merchandise

Thermometer



A-C Model WD45
S&D Inc.
27"H x 8"W
33352

Adult Folding Camp Chair



S&D Inc.
w/ carrying bag
33361

Match Box Holder



S&D Inc.
6"H x 3-3/4"D x 3"W
88809

Oil Lamp



S&D Inc.
Functional; w/ Kerosene,
Citronella or Lamp Oil
12" H
33347

Christmas Lights, Ornaments



**A-C WD45
Ornament Set**
CTH Collectibles
7001



**A-C WD45
Light Set**
CTH Collectibles
2001

Hitch Cover



S&D Inc.
Fits 2" hitch
Locking pin included
33342

Windchimes



A-C Model WD45
S&D Inc.
6-1/2"W x 36"H
55545

Also Available:
AGCO®-Allis 55543
AGCO® RT Series 55579

Windmill



S&D Inc.
8' Tall
22" Fan Blades
26" Base
99908



When looking for brand merchandise, look for the AGCO Licensed Product mark... your assurance you have a genuine licensed item. You'll see this mark on approved licensed products beginning in 2006.

To purchase merchandise featured in this catalog, see a participating AGCO dealer.

Dealer Websites

American Identity
Antonio Moreau (Canada)
Cary Francis
CTH Collectibles
Distel Grain Systems
Lone Tree Creek LLC
Protexall
Putt Putt Puzzles
Rainbow Marketing (Canada)
S&D Inc.
Streff Advertising

www.americanidentity.com
www.antoniomoreau.com
www.thecfg.com
www.cthcollectibles.com
www.distelgrain.com
www.lonetreecreek.com
www.protexallinc.com
www.putt-puttpuzzles.com
www.rainbowmarketing.ca
www.harvest-farms.com
www.streffstores.com

Retail Websites

Franklin Mint
Scale Models
Spec Cast

www.franklinmint.com
www.scalemodeltoys.com
www.toycollectorclub.com

For licensing information, including having a collectible personalized for a collector event or program, or for information regarding participating dealers, contact Jacques Baillargeon, AGCO Licensed Merchandise Manager:
jacques.baillargeon@agcocorp.com

Index

MACHINE INFORMATION

Manuals, Operators	23-28
Manuals, Service.....	23-28
Parts Books	23-28

ACCESSORIES, UNIVERSAL

Quick Hitches, Cat. 1, 2, 3	29
Tractor Toolbox, Black	29

AESTHETICS

Adhesive, Spray	51
Ammeters (includes A-C Brand version)	57
Bumper, Sheet Metal Body Panels	58
Cab Kits, Interior	51
Decals, Decal Kits, Emblems	29-47
Floor Mats.....	51
Fuel Gauges	57
Gas Shocks, Doors and Windows.....	52
Gauge Components, Adapters, Drive and Shaft Assemblies.....	58
Glass, Cab	52
Handle	58
Headliners	51
Knobs, Levers	56
Latches, Body Panels.....	58
Oil Pressure Gauges (includes A-C Brand versions).....	57
Paint Part Number Listing	50
Seats, Seat Components.....	53-55
Tachometers, Hourmeters	57
Upholstery Kits.....	51
Water Temperature Gauges (includes A-C Brand versions)	57
Wiper Blades.....	52
Wiper Motor.....	52

ENGINE

Liners, Pistons and Components / by A-C Model.....	59-85
Liners, Pistons and Components / by D-A Model	86-94

Overhaul Kits, Complete Engine / by A-C Model

160 / 6040	95
170	95
175.....	96
180, 185, 190XT	96
200, 7000	96
210, 220, 7030, 7040, 7045, 7050, 7060	96
7080.....	96
6240, 6250	96
7010, 7020	96
8010.....	96
7085.....	96
7110, 7120	97
8030, 8050, 8070, 4W220	97
9130, 9150, 9170, 9190	97
Overhaul Kits, Complete Engine / by D-A Model.....	97-99
Block Kits, Engine / by A-C Model.....	100-103
Block Kits, Engine / by D-A Model.....	104
Belts, Engine / by A-C Model	104-106
Belts, Alternator / by D-A Model.....	107

LUBRICATION

Dipsticks	108
Gaskets (Drain Plugs, Oil Filter Base, Oil Pan, Oil Pump Cover)	108
Oil Cooler Hose	109
Oil Fill Caps.....	108
Oil Pump Assemblies.....	109

ELECTRICAL

Air-Conditioning Switch.....	125
Alternators, A-C Applications	113-115
Alternators, D-A Applications	117
Blower Switch.....	125
Distributor Caps.....	110
Distributor Rotors	110
Engine Starting Switch	125
Ether Push-Start Switch.....	125
Ground Shut-Off Switch.....	125
Ground Straps, Battery	124
Ignition Coils	110
Ignition Switches	125
Indicator Light Switch	125
Light Switch.....	125
Regulators, Voltage	124
Relay	124
Safety Start Switch	125
Sending Units.....	124
Solenoids.....	124
Spark Plug Guide (Early A-C Tractors, Combines and Cotton Pickers)	111
Spark Plugs	110
Starters, A-C Applications	115-117
Starters, D-A Applications.....	118
Starting, Light Switch.....	125
Starter Cap Switch.....	125
Tune-Up Kits, Points and Condenser	110
Universal Alternators, Starters	112
Wire Sets.....	110

LIGHTING

Bulbs	126
Lamp Assemblies.....	126

FILTERS

A-C Tractor Applications, Gas (includes A-C Brand versions)	127
A-C Tractor Applications, Diesel (includes A-C Brand versions)	128
D-A Tractor Applications	128-130

FUEL COMPONENTS

Carburetor Assemblies	131
Carburetor Floats	132
Carburetor Repair Kits	131
Carburetor Gasket Kits	131
Control Cables, Fuel Shut-Off	134
Fuel Pump Assemblies, Hand Primer	132
Fuel Pumps, Diesel	132
Fuel Pumps, Gas	132
Fuel Bowls, Glass	132
Fuel Cap	134
Gaskets, Fuel-Injection	133
Lift Pump Repair Kits	134
Lift Pump Gaskets	134
Lift Pumps	134
Nozzles, Fuel-Injection	133
Pump Repair Kits, Fuel Injection	133

EXHAUST SYSTEMS

Clamps, Muffler	139
Extenders, Curved Exhaust	139
Gaskets, Exhaust	134-135
Manifolds	134
Mufflers	136-139
Rain Caps	139
Straight Pipes, Black, 24" and 48"	140
Support, Muffler	136

EXHAUST AND INTAKE

Air Cleaner Hoses	140
Blower, Hydraulic	142
Blower Motor, Air Conditioning	142
Breather Valve	140
Caps, Radiator	142
Cold-Weather Starting Aid	140
Gasket, Diffuser	140
Gaskets, Cooling Systems	143-144
Hoses, Radiator	142-143
Precleaners	141
Radiators	142
Sending Units, Cooling Systems	145
Thermostats	145
Water Pump Repair Kits	145
Water Pumps	145

FRONT AXLE AND STEERING

Final Drive, Front Axle	149
Linkage, Power-Steering	148
Seal Repair Kits, Power-Steering	148
Spindles	146
Steering Arms	148
Tie-Rod Ends	147-148
Universal U-Joint	148
Wheel Bearing Kits	149

3-PT. HITCH AND PTO

Lift-Arm Components	149
PTO Bearings, Seals	150
PTO Drivelines	150

BRAKES

Actuator Assembly	151
Caliper Repair Kit	151
Cylinders	151
Discs	151
Master Cylinder	151
Seals	151
Struts	151

CLUTCH COMPONENTS

Clutch Assemblies	154
Clutch Discs	155
Clutch Sets, Complete (Cover and Disc)	152-154
Foot Release Repair Kit	155
Pilot Bearings	152-154
Release Bearings	152-155

TRANSMISSION COMPONENTS

Bearings	156
Gears	156

REAR AXLE

Bearings	157
Seals	157

HYDRAULICS

Control Unit, Main Hydraulic	158
Pump Assemblies	158

SPECIALS

Color Sections, Helpful Information and Interesting Facts

A-C Manufacture, Serial No. and Location by Model, Year	12-22
Paint Color Note: The Evolution of A-C Orange	22
Color: Paint Application Guide, Tractor Location Key, Year, Model Series	48-49
Special Color Feature: Vintage Paint	50
Color Photo: Cab Kit for A-C 8000 Series tractor	51
Color Photos: A-C Tractor Cab, Before and After Update	52
Engine Overhaul Kit Selection and Ordering Guide	95
Bearing Return Procedure, Overhaul Kit (for Dealer)	99
Engine Block Kit Selection and Ordering Guide	100
Engine Belt Selection Guide & Gauge Tool	104

Engine Belt Alignment Notes	105-106
Rules of Engine V-Belt Tensioning, Maintenance	107
Tune-Up Specifications (A-C Models B through 190XT)	111
Cross-Reference Guide, Manufacturer OEM Part No. to Heritage Part No. Alternators	118-122
Starters	123
Allis-Chalmers Brand Filters and Applications Guide	127
Photo Section: Allis-Chalmers™ Parts Marketing Archives	159-161
Heritage® Parts Catalog Release Timeline	Back Cover

Machine Information - Allis-Chalmers



MODEL IU w/Continental Engine 1929-1932

MODEL U 1932-1950

MODEL UC w/Continental Engine 1930-1933

MODEL UC 1933-1941

MODEL IU 1937-1945

MODEL U-316 (Power Unit) 1945-1953

Tractor Serial Number is located on rear of differential housing (Models IU, U, UC); on plate on clutch inspection cover (Model U-316 / U-40).

Engine Serial Number is located on the center of LH side of cylinder block in nameplate (Model S10 Continental); RH side of cylinder block below oil filler cap (Model UM).

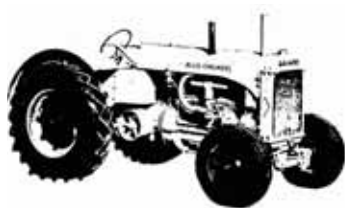

MODEL A TRACTOR AND E563 (E-60) POWER UNIT 1936-1942

Tractor Serial Number is located on transmission case ahead of gear shift quadrant.

Engine Serial Number is located on LH side of cylinder block.

Power Unit Serial Number is located on plate on clutch inspection cover.

Engine Serial Number is located on LH side of cylinder block.

Use this Serial Number Guide and Locator to accurately determine when your Allis-Chalmers tractor was manufactured. Correctly identifying this information is critical for determining the correct paint color, engine, and other important information about your specific tractor.

MODEL AND YEAR SERIAL NO.

B

1937	1 - 96
1938	97 - 11799
1939	11800 - 33501
1940	33502 - 49720
1941	49721 - 56781
1942	56782 - 61400
1943	64501 - 65501
1944	65502 - 70209
1945	70210 - 72264
1946	72265 - 73369
1947	73370 - 74079
1947	75080 - 80555
1948	80556 - 85833
1948	87834 - 92294
1949	92295 - 102392
1950	102393 - 103578
1950	106579 - 114526
1951	114527 - 118673
1952	118674 - 122309
1953	122310 - 124200
1954	124201 - 124710
1955	124711 - 126496
1956	126497 - 127185
1957	126186 - 127461

IB

1946	1001 - 1002
1947	1003 - 1009
1948	1010 - 1281
1949	1282 - 1555
1950	1556 - 1878
1951	1879 - 2118
1952	2219 - 2567
1953	2570 - 2847

C

1940	1 - 111
1941	112 - 12388
1942	12389 - 18781
1943	18782 - 23907
1944	23908 - 30694
1945	30695 - 36377
1946	36378 - 39167
1947	39168 - 51514
1948	51515 - 68280
1949	68281 - 80517
1950	50518 - 54030



MODEL B 1937-1957

Tractor Serial Number is located on top of transmission above shift pattern.

Engine Serial Number is located on rear LH side of engine between carburetor and fuel filter.



MODEL IB 1949-1957

Tractor Serial Number is located on top of transmission above gear shift pattern.

Engine Serial Number is located on the rear LH side of engine between carburetor and fuel filter.

Note: This information was taken from the 1983 Tractor Identification serial and engine number locations guide. Information was updated when possible.

Machine Information - Allis-Chalmers

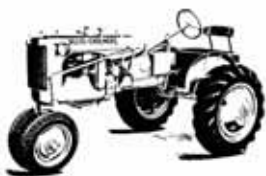

MODEL C
1940-1950

Tractor Serial Number is located on top of the transmission near shift pattern.

Engine Serial Number is located on the rear LH side of the engine.

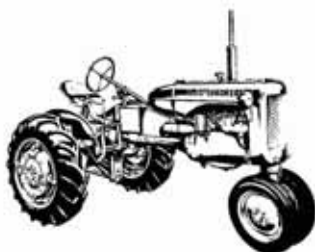

MODEL CA
1950 -1958

Tractor Serial Number is located on top of transmission next to shift pattern.

Engine Serial Number is located on the rear LH side of engine.

MODEL AND YEAR SERIAL NO.

CA	
1950	14 - 321
1951	322 - 10538
1952	10539 - 22180
1953	22181 - 31423
1954	31424 - 32906
1955	32907 - 37202
1956	37203 - 38617
1957	38976
1958	38977 - 39513

WC (Square Radiator)	
1933	WC1 - WC28
1934	WC29 - WC3126
1935	WC3127 - WC13869
1936	WC13870 - WC31783
1937	WC31784 - WC60789
1938	WC60790 - WC74329

WC (Styled)	
1938	74330 - 75215
1939	75216 - 91533
1940	91534 - 103516
1941	103517 - 114533
1942	114534 - 123170
1943	123171 - 127641
1944	127642 - 134623
1945	134624 - 148090
1946	148091 - 152844
1947	152845 - 170173
1948	170174 - 178202

WF (Square Radiator)	
1937	WF4 - 288
1938	289 - 1335
1939	1336 - 1891
1940	1892 - 1903

WF (Styled)	
1940	1904 - 2299
1941	2300 - 2703
1942	2704 - 3003
1943	NONE
1944	3004 - 3194
1945	3195 - 3509
1946	3510 - 3747
1947	3748 - 4110
1948	4111 - 5499
1949	5500 - 7317
1950	73318 - 8315
1951	83316 - 8353

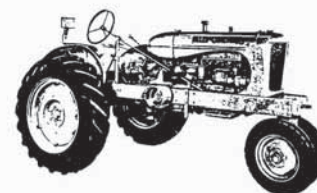

MODEL WC
1933-1948

Tractor Serial Number is located on rear of rear axle housing.

Engine Serial Number is located on LH side of engine near carburetor.

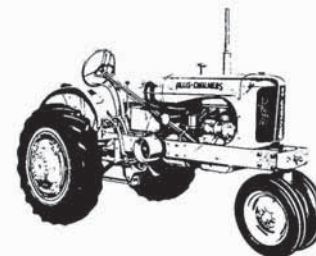

MODEL WD
1948 -1953

Tractor Serial Number is located at the LH brake cover or the LH rear of axle housing.

Engine Serial Number is located on LH side of engine near carburetor.

Machine Information - Allis-Chalmers

MACHINE INFORMATION

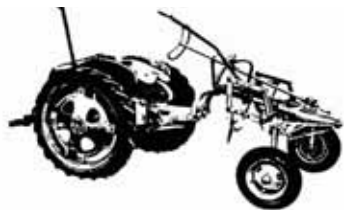

MODEL G

1948 -1955

Tractor Serial Number is located next to the starter on engine.

Engine Serial Number is located on starter side of engine near starter.

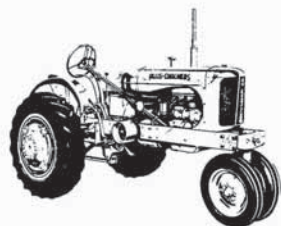

MODEL WD

1948 -1953

Tractor Serial Number is located at the LH brake cover or the LH rear of axle housing.

Engine Serial Number is located on LH side of engine near carburetor.

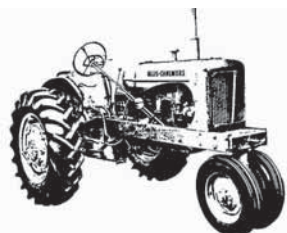

MODEL WD45

1953 -1958

Tractor Serial Number is located at the LH brake cover or the LH rear of axle housing.

Engine Serial Number is located on LH side of the engine near carburetor.

Diesel Engine Serial Number is located on LH side of engine.

MODEL AND YEAR SERIAL NO.

G

1948	6
1949	10961
1950	23180
1951	24006
1952	25269
1953	26497
1954	28036
1955	29036

WD

1948	7 - 9249
1949	9250 - 35444
1950	35445 - 72327
1951	72328 - 105181
1952	105182 - 126931
1952	127007 - 131242
1953	131243 - 146606

WD45

1953	146607 - 160385
1954	160386 - 190992
1955	190993 - 217991
1956	217992 - 230294
1957	230295 - 236958

D10 (Persian Orange #1)

1959	1001 - 1933
------	-------------

D10 (Persian Orange #2)

1960	1950 - 2702
1961	2801 - 3262

D10 (149 Cubic Inch)

1961	3501 - NA
1962	INA - 4511

D10 (Series II)

1963	6801 - 7674
1964	7675 - 7850

D10 (Series III)

1964	9001 - 9203
1965	9204 - 9485
1966	9486 - 9794
1967	9795 - 9978
1968	9979 - 10100

D12 (Persian Orange #1)

1959	1001 - 1734
------	-------------

D12 (Persian Orange #2)

1960	1950 - 2428
1961	2801 - 2919

D12 (149 Cubic Inch)

1961	3001 - NA
1962	NA - 3638

D12 (Series II)

1963	5501 - 6011
1964	6012 - 6144



MODEL D10, D12

1959-1964

Tractor Serial Number is located at the LH front end of torque housing.

Engine Serial Number is located on the rear LH side of engine block at rear of carburetor.



MODEL D10, D12 SERIES III

1964-1967

Tractor Serial Number is located at the LH front end of torque housing.

Engine Serial Number is located on the rear LH flange of the engine block.



MODEL D14

1957-1961

Tractor Serial Number is located at LH front end of torque tube.

Engine Serial Number is located on the rear LH side of engine in back of the carburetor.

Machine Information - Allis-Chalmers



MODEL D15

1960-1962

Tractor Serial Number is located at LH front end of torque tube.

Gasoline Engine Serial Number is located on the rear LH side of the engine, back of carburetor.

Diesel Engine Serial Number is located at top LH side of engine block.



MODEL D15 SERIES II

1963-1968

Tractor Serial Number is located at LH front end of torque housing.

Gasoline Engine Serial Number is located at the rear LH side of the engine block at rear of carburetor.

Diesel Engine Serial Number is located at top LH side of cylinder block.



MODEL D17

1957-1963

Tractor Serial Number is located at LH front end of torque housing.

Engine Serial Number is located on the rear LH side of engine block at rear of carburetor.

MODEL AND YEAR SERIAL NO.

D14	
1957	1001 - 9399
1959	9400 - 14899
1960	14900 - 18230
1959	19001 - 21799
1960	21800 - 24050

D15	
1960	1001 - 1899
1961	1900 - 6469
1962	6470 - 8169

D15 Series II	
1963	13001 - 16927
1964	16928 - 19680
1965	19681 - 21374
1966	21375 - 23733
1967	23734 - 25126
1968	25127 - 25419

D17	
1957	1001 - 4299
1958	4300 - 16499
1959	16500 - 23363

D17 (Black Bars)	
1959	24001 - 28199
1960	28200 - 31625

D17 (Persian Orange #2)	
1960	32001 - 32099
1961	33100 - 38069
1962	38070 - 41540

D17 Series III	
1962	42001 - 43358
1963	65001 - 70610
1964	70611 - 72768

D17 Series IV	
1964	75001 - 77089
1965	77090 - 80532
1966	80533 - 86060
1967	86061 - 89213

D19	
1961	1001 - 1249
1962	1250 - 7331
1963	12001 - 14944
1964	14945 - 16266

D21	
1963	1001 - 1416
1964	1417 - 2078
1965	2079 - 2129

D21 Series II	
1965	2201 - 2407
1966	2408 - 2862
1967	2863 - 3776
1968	3777 - 4497
1969	4498 - 4609



MODEL D17 SERIES III

1962-1964

Tractor Serial Number is located at LH front end of torque housing.

Gasoline Engine Serial Number is located at the rear LH side of the engine block at rear of carburetor.

Diesel Engine Serial Number is located at top LH side of cylinder block.



MODEL D17 SERIES IV

1965-1967

Tractor Serial Number is located at LH front end of torque housing.

Gasoline Engine Serial Number is located at the rear LH side of the engine block at rear of carburetor.

Diesel Engine Serial Number is located at top LH side of cylinder block.



MODEL D17 DIESEL

1957-1963

Tractor Serial Number is located at LH front end of torque housing.

Engine Serial Number is located on the rear LH side of engine block at rear of carburetor.

Machine Information - Allis-Chalmers

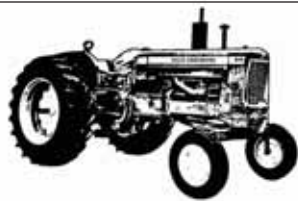

MODEL D19

1961-1964

Tractor Serial Number is located on machined surface at top rear of transmission housing.

Engine Serial Number is located at top LH side of the engine block.



MODEL D21

1963-1965

Tractor Serial Number is located on front flange of torque housing at the LH side of tractor.

Engine Serial Number is stamped on a plate located at the upper rear of engine block on the LH side.



**MODEL D21 SERIES II
TURBOCHARGED DIESEL**

1965-1969

Tractor Serial Number is located on the front flange of torque housing at the LH side of tractor.

Engine Serial Number is stamped on a plate located at the upper rear of engine block on the LH side.

MODEL AND YEAR SERIAL NO.

ED40

1963	NA
1964	NA

160

1969	NA
1970	NA
1971	NA
1972	NA
1973	NA
1974	NA

170

1967	1005 - 2720
1968	2721 - 5373
1969	5374 - 6368
1970	6369 - 6987
1971	6988 - 7384

170 (Black Hood Decal)

1971	7500 - 7796
1972	7797 - 8820
1973	8821 - 10300

175

1970	1001 - 1476
1971	1477 - 1623
1972	1624 - 1739
1973	1740 - 2152
1974	2153 - 3254
1975	3255 - 3739
1976	3740 - 4811
1977	4812 - 5662

1978	5663 - 6320
1979	6321 - 6998
1980	6999 - 7502

180

1967	1007 - 2681
1968	2682 - 6093
1969	6094 - 9234
1970	9235 - 10560
1971	10561 - 11728
1972	11729 - 12446
1973	12447 - 12985

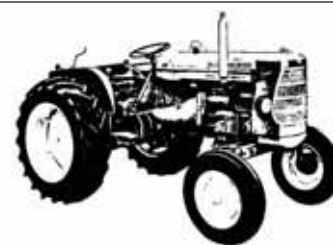

MODEL ED40

1963-1964

Tractor Serial Number is located under the seat on the LH side of the transmission.

Engine Serial Number is located on the top RH side of the cylinder block above the dynamo.



MODEL 160

1969-1974

Tractor Serial Number is located on a plate ahead of fuel tank.

Engine Serial Number is located on the LH side of cylinder block.



MODEL 170

1967-1971

Tractor Serial Number is located at the LH front side of torque housing.

Gasoline Engine Serial Number is located at the rear LH side of the engine block at rear of carburetor.

Diesel Engine Serial Number is located at top RH side of cylinder block.

Machine Information - Allis-Chalmers



MODEL ONE-SEVENTY

1971-1974

Tractor Serial Number is located at the LH front side of torque housing.

Gasoline Engine Serial Number is located at the rear LH side of the engine block at rear of carburetor.

Diesel Engine Serial Number is located at top RH side of cylinder block.



MODEL 175

1970-1980

Tractor Serial Number is located at the front of torque housing on the LH side.

Gasoline Engine Serial Number is located at the LH side of the cylinder block at the rear of the carburetor.

Diesel Engine Serial Number is stamped either on the front RH side of the cylinder block near the alternator, or on the front LH side of the cylinder block above the injection pump.



MODEL 180

1967-1974

Tractor Serial Number is located at LH front side of torque housing.

Engine Serial Number is located on LH side of engine block in front of oil filler cap.

MODEL AND YEAR SERIAL NO.

185	
1970	1001 - 1951
1971	1952 - 2934
1972	2935 - 3762
1973	3763 - 4960
1974	4961 - 6541
1975	6542 - 8366
1976	8367 - 10024
1977	10025 - 11625
1978	11626 - 13159
1979	13160 - 14671
1980	14672 - 15647
1981	15648 - 15961

190, 190XT (Bar Grille)	
1964	1001 - 2484
1965	2485 - 8218
1966	8219 - 8626
1966	9004 - 13272
1967	13273 - 17784

190, 190XT (No Bars)	
1967	19001 - 19261
1968	19262 - 22153

190, 190XT Series III	
1968	23001 - 23233
1969	23234 - 25900
1970	25901 - 29135
1971	29136 - 31056
1972	31057 - 31117
1973	31118 - 31140

200	
1972	1004 - 3343
1973	3344 - 3558
1973	4001 - 6293
1974	6294 - 9249
1975	9250 - 11521

210	
1970	1004 - 1106
1971	1107 - 2081
1972	2082 - 2496

220	
1969	1004 - 1937
1970	1938 - 2450
1971	2451 - 2625
1972	2626 - 2866



MODEL 185 DIESEL

1970-1981

Tractor Serial Number is located at the front of torque housing on the RH side.

Engine Serial Number is located on the front LH side of the cylinder block near alternator.



MODEL 190, 190XT

1964-1968

Tractor Serial Number is located at LH front side of torque housing.

Engine Serial Number is stamped on a nameplate located upper LH side of cylinder block.



MODEL 190, 190XT SERIES III

1969-1973

Tractor Serial Number is located at LH front side of torque housing.

Engine Model and Serial Number are stamped on nameplate located upper LH side of cylinder block.

Machine Information - Allis-Chalmers



MODEL 200 DIESEL

1972-1975

Tractor Serial Number is located on RH side of torque housing.

Engine Serial Number is stamped on a nameplate located on the upper LH side of cylinder block.



MODEL 210

1970-1973

Tractor Serial Number is located at the LH front of torque housing.

Engine Serial Number is located at upper rear LH side of cylinder block.



MODEL 220

1969-1973

Tractor Serial Number is located at LH front of torque housing.

Engine Serial Number is located at upper rear LH side of cylinder block.

MODEL AND YEAR SERIAL NO.

440	
1972	1001 - 1139
1973	1140 - 1339
1974	1440 - 1650
1975	1651 - NA
1976	NA - 2010

5015	
1982	1001 - 1726
1983	1727 - 3276
1984	3277 - 4231
1985	4232 - NA

5020	
1977	1001 - 2219
1978	2220 - 3090
1979	3091 - 4114
1980	4115 - 5789
1981	5790 - 7033
1982	7034 - 8387
1983	8388 - 8733
1984	8734 - 9216
1985	9217 - NA

5030	
1978	1001 - 2004
1979	2005 - 2254
1980	2255 - 2975
1981	2976 - 3519
1982	3520 - 4065
1983	4066 - 4213
1984	4214 - 4368
1985	4369 - NA

5040	
1976	408445 - NA
1977	410364 - NA
1978	462148 - NA
1979	473000 - NA
1980	474000 - NA

5045	
1981	988500 - NA

5050	
1977	573461 - NA
1978	579632 - NA
1979	584000 - NA
1980	591000 - NA
1981	596014 - NA
1982	598050 - NA



MODEL 440 DIESEL

1972-1976

Tractor Serial Number is located on the LH side of dash panel.

Engine Serial Number is located in two locations: the LH front engine block and LH rear engine block.



MODEL 5015

1982-1985

Tractor Model and Serial Number appear as the Product Identification Number (PIN). The PIN is stamped on a nameplate located on rear surface of the steering shaft support facing operator.

Give component number as stamped. Example: 5015-101 for Model 5015 or 9518-1001 for Model 9518.

Engine Model and Serial Number are located on LH side of cylinder block.

Machine Information - Allis-Chalmers



MODEL 5020, 5030 COMPACT DIESEL

5020 – 1977-1985
5030 – 1978-1985

Tractor Model and Serial Number are stamped on a nameplate located on rear surface of the steering gearbox facing operator.

Engine Model and Serial Number are located on LH side of the cylinder block.

Transmission Model and Serial Number are located on RH side of cylinder block.



MODEL 5040

1975-1981

Tractor Serial Number is located on a plate on the rear of the console under the steering wheel.

Engine Serial Number is located on the LH side of the engine block.



MODEL 5050

1976-1982

Tractor Serial Number is located on the nameplate on the rear of the console under the steering wheel.

Engine Serial Number is located on the LH side of the engine block.

MODEL AND YEAR SERIAL NO.

6040	
1975	NA
6060	
1980	1001 - 1296
1981	1297 - 2462
1982	2463 - 2893
1983	3894 - 4571
1984	4572 - 5027
6070	
1984	1001 - 1608
1985	1609 - 1972
6080	
1980	1001 - 1151
1981	1152 - 3001
1982	3002 - 4566
1983	4567 - 5779
1984	5780 - 6852
1985	6850 - 7698
6140	
1982	1001 - 1446
1983	1447 - 1850
1984	1851 - 2710
1985	2711 - 2714
1986	3545 - 3732
7000 (Maroon)	
1975	1001 - 1647
1976	1648 - 5035
1977	5036 - 6372
1978	6373 - 6760
7000 (Black)	
1978	8000 - 8962
1979	8963 - 9503
7010	
1979	1001 - 1924
1980	1925 - 2805
1981	2806 - 3433
7020	
1977	1001 - 1316
1978	1317 - 2731
1979	2732 - 3841
1980	3842 - 4709
1981	4710 - 5209



MODEL 5045

1981

Tractor Serial Number is located on the nameplate on the rear of the console under the steering wheel.

Engine Serial Number is located on the LH side of the engine block.

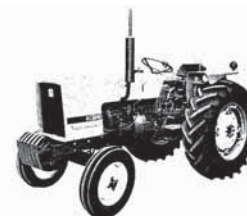

MODEL 6040

1975

Tractor Serial Number is located on a plate ahead of the fuel tank at the RH side of the tractor.

Engine Serial Number is stamped on the RH side of the cylinder block under the intake manifold.



MODEL 6060, 6080

6060 – 1980-1984
6080 – 1980-1985

Tractor Serial Number is located on the RH side of the adapter housing.

Engine Serial Number is stamped on a nameplate located on upper LH side of cylinder block.

Models in 1982 have a PIN (Product Identification Number) as 8000 Series.

Machine Information - Allis-Chalmers



MODEL 6140
1982

Tractor Model and Serial Number appear as the Product Identification Number (PIN). The PIN is stamped on a plate located on LH side of clutch housing.

Engine Model and Serial Number are stamped on LH side of cylinder block.



MODEL 7000
1975-1979

Tractor Serial Number is located on RH side of differential housing.

Engine Serial Number is stamped on a nameplate located on upper LH side of cylinder block.



MODEL 7010
1979-1981

Tractor Serial Number is located on the rear side of the differential housing above the PTO shield.

Engine Serial Number is stamped on a nameplate located on upper LH side of cylinder block.

MODEL AND YEAR SERIAL NO.

7030	
1973	1001 - 2594
1974	2596 - 4398
7040	
1974	1001 - 1302
1975	1303 - 4128
1976	4129 - 6839
1977	6840 - 8250
7045	
1977	1001 - 1233
1978	1234 - 2151
1979	2152 - 3398
1980	3399 - 4224
1981	4225 - 4888
7050	
1973	1001 - 1687
1974	1688 - 3300
7060 (Maroon)	
1974	1001 - 1298
1975	1299 - 2748
1976	2749 - 4581
1977	4582 - 5644
7060 (Black)	
1978	6001 - 6788
1979	6789 - 7692
1980	7693 - 8441
1981	8442 - 9142
7080 (Maroon)	
1974	1001 - 1006
1975	1007 - 1571
1976	1572 - 2500
1977	2501 - 2930
7080 (Black)	
1978	3001 - 3267
1979	3268 - 3647
1980	3648 - 3953
1981	3954 - 4225



MODEL 7020
1977-1981

Tractor Serial Number is located on the rear side of the differential housing above the PTO shield.

Engine Serial Number is stamped on a nameplate located on upper LH side of cylinder block.



MODEL 7030
1973-1974

Tractor Serial Number is located on the rear side of the differential housing above the PTO shield.

Engine Model and Serial Number are stamped on a nameplate located on upper LH side of cylinder block.



MODEL 7040
1974-1977

Tractor Serial Number is located on the rear side of the differential housing above the PTO shield.

Engine Model and Serial Number are stamped on a nameplate located on upper LH side of cylinder block.

Machine Information - Allis-Chalmers



MODEL 7045

1977-1981

Tractor Serial Number is located on the rear side of the differential housing above the PTO shield.

Engine Serial Number is stamped on a nameplate located on upper LH side of cylinder block.



MODEL 7050

1973-1974

Tractor Serial Number is located on the rear side of the differential housing near the PTO outlet.

Engine Model and Serial Number are stamped on a nameplate located on upper LH side of cylinder block.



MODEL 7060

1974-1981

Tractor Serial Number is located on the rear side of the differential housing above the PTO shield.

Engine Model and Serial Number are stamped on a nameplate located on upper LH side of cylinder block.

MODEL AND YEAR SERIAL NO.

7580 (Maroon)	
1976	1001 - 1287
1977	1288 - 1604
1978	1605
7580 (Black)	
1978	2001 - 2217
1979	2218 - 2485
1980	2486 - 2716
1981	2717 - 3018
8550	
1977	1001 - 1082
1978	1083 - 1341
1979	1342 - 1552
1980	1553 - 1722
1981	1723 - 2021
8010	
1981	1001 - 1019
1982	1020 - 1711
1983	1712 - 2265
1984	2266 - 2608
1985	2609 - 2832
8030	
1981	1001 - 1008
1982	1009 - 2092
1983	2093 - 2700
1984	2701 - 3145
1985	3146 - 3328



MODEL 7080

1974-1981

Tractor Serial Number is located on the rear side of the differential housing above the PTO shield.

Engine Serial Number is stamped on a nameplate located on upper LH side of cylinder block.



MODEL 7580

1976-1981

Tractor Serial Number is located on the rear LH side of front frame.

Engine Serial Number is stamped on a nameplate located on upper LH side of cylinder block.



MODEL 8010, 8030

1981-1985

Tractor Model and Serial Number appear as the Product Identification Number (PIN). The PIN is located on top surface of LH side frame.

Engine Model and Serial Number are stamped on a nameplate located on upper LH side of cylinder block.

Machine Information - Allis-Chalmers



MODEL AND YEAR	SERIAL NO.
8050	
1981	1001 - 1015
1982	1016 - 1923
1983	1924 - 2495
1984	2496 - 3186
1985	3187 - 3336

8070	
1981	1001 - 1003
1982	1004 - 1429
1983	1430 - 2089
1984	2090 - 2902
1985	2903 - 3354

4W220	
1981	1001 - 1002
1982	1003 - 1080
1983	1081 - 1144
1984	1145 - 1175

4W305	
1981	1001 - 1003
1982	1004 - 1111
1983	1112 - 1175
1984	1176 - 1337
1985	1338 - 1412



MODEL 4W220
1981-1984

Tractor Model and Serial Number appear as the Product Identification Number (PIN). The PIN is located on top surface of LH side frame.

Engine Model and Serial Number are stamped on a nameplate located on upper LH side of cylinder block.

MODEL 8050, 8070
1981-1985

Tractor Model and Serial Number appear as the Product Identification Number (PIN). The PIN is located on top surface of LH side frame.

Engine Model and Serial Number are stamped on a nameplate located on upper LH side of cylinder block.



MODEL 8550
1977-1981

Tractor Serial Number is located on the rear LH side of the front frame.

Engine Serial Number is stamped on a nameplate located on upper LH side of cylinder block.



MODEL 4W305
1981-1985

Tractor Model and Serial Number appear as the Product Identification Number (PIN). The PIN is located on top surface of LH side frame.

Engine Model and Serial Number are stamped on a nameplate located on upper LH side of cylinder block.

A Paint Color Note

Double-check the tractor's Serial Number to make sure you have the correct color, because the specifications for Allis-Chalmers orange have changed over the years.

Allis-Chalmers used three different shades of Orange.

1929 - 1960	Persian Orange #1
1961 - 1977	Persian Orange #2
1978 - 1985	Corporate Orange

For more details, refer to the paint section that begins on page 48.

Manuals, Parts Books

MUO	Serial No.	Operators Manual	Service Manual	Parts Book
ALLIS-CHALMERS				
A & Power Unit E563		NA	79003401	79003122
B		70257986	79003403	79009414
IB		70257982	NA	70257982
C		70257985	79003403	79009414
CA		70257984	79003403	79003119
ED40		70257955	NA	79004710
G		70257983	79003403	79003102
U		NA	79003401	79003118
IU		NA	79003401	79003118
UC		NA	79003401	79003118
WC		70257978	NA	79009413
WD		70257977	79003405	79005698
WD45 Gas		70257975	79003405	79005698
WD45 Diesel		70257976	79003405	79005698
WF		NA	NA	79009413
D10	Prior to SN 3501	70257972	79003406	79001835
D10	SN 3501 - 9001	70257971	79003406	79001835
D10	Eff. SN 9001	70257970	79003406	79001835
D12	Prior to SN 3001	70257972	79003406	79001835
D12	SN 3001 - 9000	70257971	79003406	79001835
D12	Eff. SN 9001	70257970	79003406	79001835
D14	Prior to SN 19001	70257969	79003405	79003125
D14	Eff. SN 19002	70257968	79003405	79003125
D15 Gas	Prior to SN 13001	70257967	79003407	79008409
D15 Diesel	Prior to SN 13001	70257966	79003407	79008409
D15 II Gas	Eff. SN 13002	70257965	79003407	79008409
D15 II Diesel	Eff. SN 13002	70257965	79003407	79008409
D17 Gas	Prior to SN 24001	70257964	79003408	79006751
D17 Gas	SN 24002 - 42001	70257962	79003408	79006751
D17 Diesel	Prior to SN 24001	70257963	79003408	79006751
D17 Diesel	SN 24001 - 42001	70257961	79003408	79006751
D17	SN 42001 - 75001	70257960	79003408	79006751
D17 IV	Eff. SN 75001	70257959	79003408	79003152
D19		70257958	79003409	79003140
D21 Diesel		70257957	79003410	79003143
D21 II Diesel Turbo		70257956	79003410	79003143
160	Prior to SN 144045	70257954	79003411	79001341
160	Eff. SN 144046	70257953	79003411	79001341
170	Prior to SN 07500	70257952	79003412	79007024
170	Eff. SN 07501	70257354	79003412	79007024
175	Prior to SN 2151	79004709	79003412	79007024
175	Eff. SN 2152	70261774	79003412	79007024
180	Prior to SN 12800 E597H601	70257951	79003413	79006850
180	Eff. SN 12801	70261781	79003413	79006850
185	Eff. SN 12801	70261781	79003413	79006528
190	Prior to SN 23001	70257950	79003414	79006410
190XT	Prior to SN 23001	70257950	79003414	79006410
190 Series III	Eff. SN 23002	70257949	79003414	79006410
200	Eff. SN 4001	70257947	79003415	79007389



70257950



79003037



72097373



72102222



70261571



70257967

Manuals, Parts Books

MUO	Serial No.	Operators Manual	Service Manual	Parts Book
ALLIS-CHALMERS CONTINUED				
200	Eff. SN 4002	70257211	79003415	79007389
210		70257946	79003416	79001748
220		70257945	79003416	79001342
440	Prior to SN 1460	79003037	79003418	79005017
440	Eff. SN 1460	79003095	79003418	79005017
5040 6-9 Speed		72088554	79003450	79006636
5040 8-12 Speed		72088729	79003450	79006636
5045		72088739	79003450	79006527
5050		72088901	79003487	79006535
6040		72074367	79003411	79003866
6060		70272426	79005313	79007388
6070	Eff. SN 1001	70275862	79005313	79006969
6080	Prior to SN 4000	70272426	79005313	79012248
6080	Eff. SN 4000	70275862	79005313	79012248
6140		72099286	79005320	79006646
6150		70276877	79016010	79010689
7000	Prior to SN 8000	70261096	79003467	79006102
7000	Eff. SN 8001	70271394	79003467	79006529
7010		70272202	79003486	79006497
7020	Prior to SN 4580	70262680	79003486	79005677
7020	Eff. SN 4581	70261879	79003486	79005677
7030		70268338	79003417	79007023
7040		70269527	79003417	79006407
7045		70262681	79003486	79005678
7050		70268339	79003417	79002947
7060	Prior to SN 6001	70269528	79003417	79006523
7060	Eff. SN 6002	70261570	79003417	79006523
7080	Prior to SN 3001 E823	70269343	79003417	79004774
7080	Eff. SN 3002	70261571	79003417	79004774
7580	Prior to SN 2001	70270120	79003496	79005865
7580	Eff. SN 2001	70261572	79003496	79005865
8010		70275872	79005321	79012017
8030		70275872	79005321	79012182
8050		70270957	79005321	79017043
8070		70270957	79005321	79017044
8550		70261940	79003496	79006096
4W220		70273459	79005323	79012091
4W305		70273460	79005323	79010151
ALLIS-CHALMERS, DEUTZ-ALLIS COMPACT TRACTORS				
5015		72097373	79005322	79006649
5020, 5020 4WD		72097271	79003451	79009152
5030		NA	79003451	79009152
DEUTZ-ALLIS COMPACT TRACTORS				
5215 Hydrostatic		72118510	79005354	79012272
5215 Synchro-Shift		72118582	79005354	79009296
5220 Hydrostatic		72118708	79005362	79009486
5220 Synchro-Shift		72102222	79005330	79009488
5230		72102222	79005330	79009810



70257963



70257964



70257958

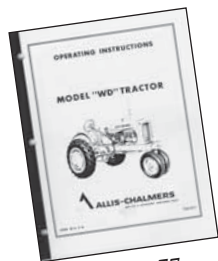

70257977



70257954

Manuals, Parts Books

MUO	Serial No.	Operators Manual	Service Manual	Parts Book
AGCO-ALLIS				
4650		72200444	72200007	79017177
4660		72200444	72200007	79017189
5650		72201150	79017097	79016724
5660		72201150	79017097	79016724
5670	Prior to SN 1500	72200445	72200008	79016693
5670	Eff. SN 1501	72201413	72200008	79016596
5680	Prior to SN 1500	72200445	72200008	79016704
5680	Eff. SN 1501	72201413	72200008	79017020
6670		72200446	72200008	79017105
6680		72200446	72200008	79017180
6690		72200446	72200008	79017289
7600		72200447	72200009	79017309
7630		72200447	72200009	79018518
7650		72200447	72200009	79016983
8610		72200448	79014982	79017321
8630		72200448	79014982	79017321
8745 (Cab)		1857081M3	1857088M91	79019062
8745 (Cab)	Cummins Engine	1857205M1	NA	79019862
8745 (Footstep)		1857117M2	1857088M91	79019862
8745 (Footstep)	Cummins Engine	1857206M1	NA	79019862
8765 (Cab)		1857081M3	1857088M91	79019863
8765 (Cab)	Cummins Engine	1857205M1	NA	NA
8765 (Footstep)		1857117M2	1857088M91	79019863
8765 (Footstep)	Cummins Engine	1857206M1	NA	NA
8775	SisuDiesel Engine	3378092M2	79017536	79017911
8775	J117019, Cummins Engine	3378092M3	NA	79019161
8785	SisuDiesel Engine	3378092M2	79017536	79017789
8785	J117019, Cummins Engine	3378092M3	NA	19019161
9435		72505900	79016312	79018743
9435	Eff. SN 93601M	72512953	79016312	79018743
9455		72505900	79016312	79018743
9455	Eff. SN 956301M	72512953	79016312	79018743
9630	SN 920001 - 920999	72503723	79015814	79016748
9630	SN 921001 - 921500	72506797	79015814	79016748
9630	Eff. SN 921501	72511976	79015814	79016748
9635	Prior to SN 932001	72505897	79015814	79019078
9635	Eff. SN 932001	72511978	79015814	79019078
9635	Eff. SN 932304P	72512955	79015814	79019078
9650	SN 940001 - 940999	72503723	79015814	79016748
9650	SN 941001 - 941500	72506797	79015814	79016748
9650	Eff. SN 941501	72511976	79015814	79016748
9655	Prior to SN 952001	72505897	79015814	79019078
9655	Eff. SN 952001	72511978	79015814	79019078
9655	Eff. SN 952306P	72512955	79015814	79019078
9670	Prior to SN 961001	72503722	79015814	79016819
9670	SN 961001 - 961999	72506798	79015814	79016819
9670	Eff. SN 962001	72511977	79015814	79016819
9675	Prior to SN 972000	72505898	79015814	79016362
9675	Eff. SN 972001	72511979	79015814	79016362
9675	Eff. SN 972308P	72512957	79015814	79016362
9690	Prior to SN 981001	72503722	79015814	79016819



72201150



70257354



70270957

Manuals, Parts Books



79004709



70257971

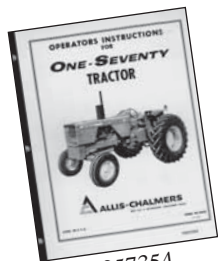

70257354



702617174



70261781

MUO	Serial No.	Operators Manual	Service Manual	Parts Book
AGCO-ALLIS CONTINUED				
9690	Eff. SN 981999	72506798	79015814	79016819
9690	Eff. SN 982001	72511977	79015814	79016819
9695	Prior to SN 992001	72505898	79015814	79016362
9695	Eff. SN 992001	72511979	79015814	79016362
9695	Eff. SN 992301P	72512957	79015814	79016362
9735		3378094M1	79017535	79019858
9745		3378094M1	79017535	79019859
9755		5016773M1	79018655	79017624
9755	Cummins Supplement	NA	NA	79021596
9755	Eff. SN 2001	NA	NA	79019248
9765		5016773M1	79018655	79017626
9765	Cummins Supplement	NA	NA	79021598
9765	Eff. SN 2001	NA	NA	79019248
9775		5016773M1	79018655	79017628
9775	Cummins Supplement	NA	NA	79021600
9775	Eff. SN 2001	NA	NA	79019270
9785		5016773M1	79018655	79017630
9785	Cummins Supplement	NA	NA	79021602
9785	Eff. SN 2001	NA	NA	79019270
9815	Prior to SN 902000	72505896	79015814	79016357
9815	Eff. SN 902001	72511980	79015814	79016357
9815	Eff. SN 902315P	79017156	79015814	79016357
DEUTZ-ALLIS (GREEN)				
6150		70276877	79016010	79010689
6240 Vario Cab		2986265	NA	5000844
6250 Vario Cab		2986265	NA	5000845
6250 VF		2986381	NA	79011976
6260 Vario Cab		2986265	NA	5000846
6260 Star Cab		2986265	NA	5000851
6260 VF		2986381	NA	79011976
6265 ROPS - Vario Cab		2986265	NA	5000847
6265 Star Cab		2986265	NA	5000852
6275 ROPS		2986265	NA	5000848
6275 F		2986381	NA	79011976
6275 Star Cab		2986265	NA	5000853
7085		2986291	2986365	79015732
7110		2986291	2986365	NA
7120		2986291	NA	NA
7120		2986362	2986365	NA
7145		2986321	2986365	NA
9130		72198030	79005361	79014883
9150		72198030	79005361	79014883
9170		72198056	79005361	79014884
9190		72198056	79005361	79014884

Manuals, Parts Books

MUO	Serial No.	Operators Manual	Service Manual	Parts Book
DEUTZ-FAHR				
D2505		NA	NA	NA
D3005		NA	NA	NA
D4005		NA	NA	NA
D4505		NA	NA	5000615
D5005		NA	NA	5000614
D5505		NA	NA	NA
D6005		NA	NA	NA
D8005		NA	NA	NA
D9005		NA	NA	5000610
D2506		2971462	NA	5000646
D3006		2971462	NA	5000691
D4006		2971462	NA	5000693
D4506		2971462	NA	5000694
D5006		NA	NA	NA
D5206		2971464	NA	5000695
D5506		NA	NA	5000666
D6006		NA	NA	5000668
D6206		2971464	NA	NA
D6806		2971466	NA	5000697
D7006		NA	NA	5000669
D7206		2971466	NA	5000698
D8006		2971770	NA	5000748
D9006		20228	NA	5000600
D10006		2971770	NA	5000749
D13006		2971770	NA	5000750
D2807		2986151	NA	NA
D3607		2986151	NA	5000790
D4507	82	2973117	NA	NA
D4507	82	2986127	NA	NA
D5207	82	2973117	NA	5000824
D5207	82	2986127	NA	5000824
D6207		2973117	NA	5000826
D6507		2986127	NA	5000771
D6507C		2986131	NA	5000781
D6807		2973159	NA	5000772
D7007		2986127	NA	5000773
D7007C		2986131	NA	5000783
D7807	82	2973159	NA	5000775
D7807	82	2986127	NA	5000775
D7807C	82	2986083	NA	5000785
D7807C	82	2986131	NA	5000785
DX90	76 Series	2973128	NA	5000712
DX90	78 Series	2986115	NA	5000794
DX110	Eff. SN 7620	2973128	NA	5000713
DX120	76 Series	2986091	NA	5000715
DX120	78 Series	2986115	NA	5000796
DX130		2973089	NA	5000716
DX140	76 Series	2971814	NA	5000717



7220047



70257983



72200445



70257986



70257961

Manuals, Parts Books



70257970



72200446



2986265



72118582

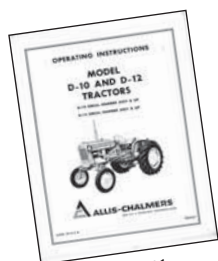

70257971



72118510



72102222



70276877



72201413



72118708



2986288

MUO	Serial No.	Operators Manual	Service Manual	Parts Book
DEUTZ-FAHR				
DX145	76 Series	2973089	NA	5000716
DX145	78 Series	2986115	NA	5000797
DX160	78 Series	2986105	NA	5000818
DX160	76 Series	2971814	NA	5000717
DX3.10		NA	NA	NA
DX3.30 V/C	Vario Cab	NA	NA	5000845
DX3.50	Vario Cab	NA	NA	5000846
DX3.50	Star Cab	NA	NA	5000851
DX3.70	ROPS - Vario Cab	NA	NA	5000847
DX3.70	Star Cab	NA	NA	5000852
DX3.90	ROPS - Vario Cab	NA	NA	5000848
DX3.90	Star Cab	NA	NA	5000853
DX4.70		2986288	NA	5000858
DX6.30		2986288	NA	79015197
DX6.50		2986288	NA	5000861
DX7.10		2986321	NA	5000862
DX8.30		2986284	NA	5000806
INTRAC 2002		2971574	NA	NA
INTRAC 2003		2971574	NA	NA
INTRAC 2004		2971979	NA	5000809
Agri Star 8.31	Prior to SN 94	NA	NA	79015917
Agri Star 8.31	Eff. SN 94	NA	NA	79016164

Universal Quick Hitches

Part No.	Description	Weight (lb/kg)	Dimensions (in/cm)
QUICK HITCHES			
79023042V	Category 1	76 lb / 34.4 kg	30" x 10" x 24" (76x25x61 cm)
79023871V	Replacement Upper Hook, Category 1		
79023043V	Category 2	134 lb / 60.7 kg	38" x 9" x 23" (96x23x58 cm)
79023044V	Category 2 Heavy Duty	160 lb / 72.5 kg	38" x 9" x 25" (96x23x63 cm)
79023962V	Category 2/3	192 lb / 87 kg	43.5" x 9" x 29" (110x23x74 cm)
79023045V	Category 3	182 lb / 82.5 kg	43.5" x 9" x 29" (110x23x74 cm)
79023046V	Category 3 Narrow	176 lb / 79.8 kg	39" x 9" x 29" (99x23x74 cm)
BUSHINGS			
79023086V	Category 1 Bushing		
79023087V	Category 2 Bushing		

Quick Hitch includes one set of bushings

Decals, Decal Kits

Description	Component(s)	Part No.
WC, WF (W201)		
Hood, A-C	Decal	70232050V
Drawbar Instructions	Decal	70256569V
Decal Kit		70226503V
	Allis-Chalmers (2)	
	Battery Instructions	
	Wiring Diagram	
	Cylinder Block Drain	
	Air Cleaner Instructions	
	Radiator Shutter Instructions	
	Steering Shaft U-Joint Instructions	
	Oil Filter	
	Wheel Rim	
WD, WD45, WD45D (W226)		
Hood, A-C	Decal	70232050V
Decal Kit		70226503V
	Allis-Chalmers (2)	
	Battery Instructions	
	Wiring Diagram	
	Cylinder Block Drain	
	Air Cleaner Instructions	
	Radiator Shutter Instructions	
	Steering Shaft U-Joint Instructions	
	Oil Filter	
	Wheel Rim	
	Hydraulic Pump	
	Pump Control Hand Lever	
	WD45 (2)	
	WD (2)	
	Snap Coupler Designation	
	Engine Designation	

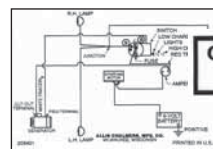
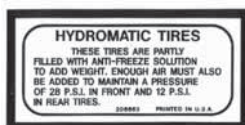

GREASE UNIVERSAL JOINT REGULARLY
PRINTED IN U.S.A.

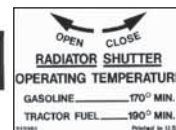

Category 2/3 Quick Hitch

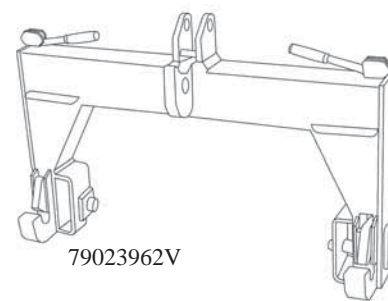

79023962V

Universal Tractor Toolbox

Black Frame-Mount Toolbox
Heavy-Duty



72160035V

Also order Bracket for
attaching Toolbox to tractor.
Part No. 72509278

AESTHETICS

ALLIS-CHALMERS

Decals, Decal Kits

AESTHETICS

Description	Component(s)	Part No.
CA		
Decal Kit		70225338V
	Allis-Chalmers (2)	
	Battery Instructions	
	Wiring Diagram	
	Radiator Shutter Instructions	
	Cylinder Block Drain	
	Clutch Lubrication	
	Air Cleaner Oil Level	
	Air Cleaner Instructions	
	Oil Filter	
D10, D12		
Ether Start	Decal	70242583V
Drawbar Instructions	Decal	70256569V
Hood, Allis-Chalmers	Decal	70232050V
Hand Lever (Pump Control)	Decal	70228708V
Engine Designation	Decal	70229977V
Position Control	Decal	70242246V
Traction Booster	Decal	70242249V
Warning, PTO	Decal	70271600V
Safety	Decal	70273992V
A-C Logo	Decal	70924244V
Decal Kit		70241765V
(Prior to SN D10-3501 & D12-3001)	Snap Coupler	
	Hydraulic Pump Instructions	
	Air Cleaner Instructions	
	Engine Designation	
	Hydraulic Pump Adjustment (3-pt. Hitch)	
(Eff. SN D10-9001 & D12-9001)	Shift Pattern	
(Eff. SN D10-9001 & D12-9001)	Position Control	
(Eff. SN D10-9001 & D12-9001)	Traction Booster	
	Drawbar Instructions	
	PTO Clutch & Brake	
	Patent	
	Warning	
D14		
Ether Start	Decal (Auxiliary Motor - D14)	70242583V
Drawbar Instructions	Decal (Auxiliary Motor - D14)	70256569V
Hood, A-C	Decal (Auxiliary Motor - D14)	70232050V
Warning, PTO	Decal	70271600V
Safety	Decal	70273992V
Snap Coupler	Decal	70226684V
Hand Lever (Pump Control)	Decal	70228708V
Engine Designation	Decal	70229977V
Decal Kit (Eff. SN 9001)	Multiple Decals	70240148V
Decal Kit (Prior to SN 9001)	Multiple Decals	70233542V

Decals, Decal Kits

Description	Component(s)	Part No.
D15		
Ether Start	Decal	70242583V
Hood, A-C	Decal	70232050V
Air Cleaner Instructions	Decal	70239522V
Air Cleaner Instructions	Decal	70235896V
Decal Set (Eff. SN 9001) D15 II	Multiple Decals	70240148V
Decal Set (Prior to SN 9001)	Multiple Decals	70233542V
D17		
D17 (Prior to SN 42001)	Decal (Prior to Series IV)	70234442V
Drawbar Instructions	Decal	70256569V
Ether Start	Decal	70242583V
Hood, A-C	Decal	70232050V
Air Cleaner Instructions	Decal	70235896V
Position Control	Decal	70242246V
Traction Booster	Decal	70242249V
Warning, PTO	Decal	70271600V
Safety	Decal	70273992V
A-C Logo	Decal (Series IV)	70924244V
Hand Lever (Pump Control)	Decal (Prior to Series IV)	70228708V
Patent Decal	Decal (Prior to Series IV)	70268404V
Decal Kit (Diesel) (Eff. SN 42001) (Prior to Series IV)		70237555V

- Snap Coupler
- PTO Warning
- Position Control
- Traction Booster
- Drawbar Instructions
- Dismounting Instructions
- Injection Pump Shut-Off
- Shift Pattern
- Air Cleaner Instructions
- Power Director Light
- RH Radiator Shell
- LH Radiator Shell
- RH Hood
- LH Hood
- RH Fuel Tank
- LH Fuel Tank

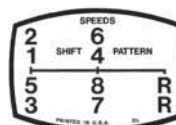
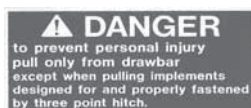
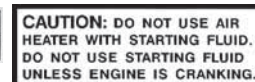

AESTHETICS

Description	Component(s)	Part No.
D17 CONTINUED		
Decal Kit - Series IV (Diesel)		70241969V
	Snap Coupler	
	PTO Warning	
	Position Control	
	Traction Booster	
	Drawbar Instructions	
	Dismounting Instructions	
	Injection Pump Shut-Off	
	Shift Pattern	
	Air Cleaner Instructions	
	Power Director Light	
	RH Radiator Shell	
	LH Radiator Shell	
	RH Hood	
	LH Hood	
	RH Fuel Tank	
	LH Fuel Tank	
Decal Kit - Series IV (Gas)		70241970V
	PTO Warning	
	Snap Coupler	
	Position Control	
	Traction Booster	
	Engine Designation	
	Drawbar Instructions	
	Dismounting Instructions	
	Air Cleaner Instructions	
	Shift Pattern	
	Power Director Light	
	RH Radiator Shell	
	LH Radiator Shell	
	RH Hood	
	LH Hood	
	RH Fuel Tank	
	LH Fuel Tank	
	Patent	
D19 (GAS)		
A-C, Rear Fuel Tank	Decal	70243073V
Ether Start	Decal	70242583V
Decal Kit	Multiple Decals	70236440V
D19 (DIESEL)		
A-C, Rear Fuel Tank	Decal	70243073V
Ether Start	Decal	70242583V
Decal Kit		70236736V
	Warning	
	Snap Coupler	
	RH Radiator Shell	
	LH Radiator Shell	
	RH Hood	
	LH Hood	

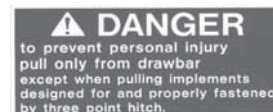

Continued on Next Page

Decals, Decal Kits

Description	Component(s)	Part No.
-------------	--------------	----------



D19 (DIESEL) CONTINUED

Decal Kit (continued)	RH Fuel Tank LH Fuel Tank Shift Pattern Drawbar Instructions Caution	
-----------------------	--	--



160

Allis-Chalmers Logo	Decal	70924243V
Allis-Chalmers	Decal	70254419V
LH Hood, Allis-Chalmers	Decal	70255273V
RH Hood, Allis-Chalmers	Decal	70255274V
Drawbar Instructions	Decal	70256569V
“Diesel”	Decal	70243481V
Injection Pump	Decal	70255618V
“Landhandler”	Decal	70255294V
Allis-Chalmers Logo	Decal	70255293V
Crop Hustler	Decal	70255277V
Ether Start	Decal	70242583V
Safety	Decal	70273992V
PTO Warning	Decal	70271600V

170, 175

“Landhandler”	Decal	70255294V
Allis-Chalmers Logo	Decal	70255293V
Crop Hustler	Decal	70255277V
Diesel	Decal	70243481V
Drawbar Instructions	Decal	70256569V
Ether Start	Decal	70242583V
RH Hood, Allis-Chalmers	Decal (Prior to SN 170-7500)	70249055V
LH Hood, Allis-Chalmers	Decal (Prior to SN 170-7500)	70249056V
LH Hood, Model Designation	Decal 170 (Prior to SN 170-7500)	70249727V
RH Hood, Model Designation	Decal 170 (Prior to SN 170-7500)	70249728V
RH Hood, Model Designation	Decal 170 (Eff. SN 170-7500)	70256070V
LH Hood, Model Designation	Decal 170 (Eff. SN 170-7500)	70256071V
Piston Control	Decal	70255679V
Position Control	Decal	70242246V
Traction Booster	Decal	70242249V
Fuel Injection Pump	Decal	70255618V
Drawbar Instructions	Decal	70256569V
Shift Pattern	Decal, 170	70256877V
Shift Pattern, w/Shuttle Clutch	Decal, 170	70257283V
Patent	Decal	70268404V
Instructions	Decal	70249908V
PTO Warning	Decal	70271600V
PTO Warning, w/Shuttle Clutch	Decal	70271602V
Dismounting Instructions	Decal	70273992V
A-C	Decal	70924244V



70924243V



70256071V

AESTHETICS

Decals, Decal Kits

Description	Component(s)	Part No.
170, 175 CONTINUED		
Decal Kit - Gas (Eff. SN 170-7501)		70256072V



70255273V



70242249V

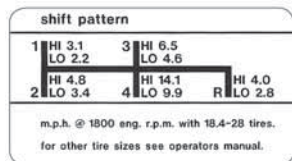

70257283V

- Oil Pressure
- RH Hood
- LH Hood
- A-C Logo
- Air Cleaner
- Shift Pattern
- Dismounting Instructions
- Traction Booster
- Position Control
- PTO Warning
- Drawbar Instructions
- Warning
- Warning, Fasten Seat Belts
- Warning, Keep Guards in Place
- Shift Pattern w/Shuttle Clutch

Decal Kit - Gas (Prior to SN 170-7500)		70249858V
--	--	-----------

- Oil Pressure
- RH Hood
- LH Hood
- Air Cleaner
- Shift Pattern
- Dismounting Instructions
- Traction Booster
- PTO Warning
- Position Control
- Drawbar Instructions

Decal Kit - Diesel (Eff. SN 170-7501)		70256073V
---------------------------------------	--	-----------

- Injection Pump, Diesel
- Oil Pressure
- RH Hood
- LH Hood
- A-C Logo
- Air Cleaner
- Shift Pattern
- Dismounting Instructions
- Traction Booster
- Position Control
- PTO Warning
- Drawbar Instructions
- Warning
- Warning, Fasten Seat Belts
- Warning, Keep Guards in Place

AESTHETICS

Decals, Decal Kits

Description	Component(s)	Part No.
170, 175 CONTINUED		
Decal Kit - Diesel (Prior to SN 170-7500)		70249859V
	Injection Pump Diesel	
	Oil Pressure	
	RH Hood	
	LH Hood	
	Air Cleaner	
	Ether	
	Position Control	
	PTO Warning	
	Diesel	
	Shift Pattern	
	Dismounting Instructions	
	Traction Booster	
180, 185 (PRIOR TO SN 12800)		
"Landhandler"	Decal	70255294V
Allis-Chalmers Logo	Decal	70255293V
Crop Hustler	Decal	70255277V
Drawbar Instructions	Decal	70256569V
Ether Start	Decal	70242583V
LH Hood, A-C	Decal, 180	70249055V
RH Hood, A-C	Decal, 180	70249056V
LH Hood, Model Designation	Decal, 180	70249057V
RH Hood, Model Designation	Decal, 180	70249058V
A-C, Seat	Decal	70924244V
Safety	Decal	70273992V
Engine Oil Pressure	Decal	70240646V
Position Control	Decal	70242246V
Traction Booster	Decal	70242249V
Air Cleaner Instructions	Decal	70249908V
Throttle	Decal	70254705V
Injection Pump	Decal	70255619V
Piston Control	Decal	70255679V
Shift Pattern	Decal	70256879V
Maximum Weight Limit	Decal	70261549V
Shift Pattern	Decal	70261555V
LH Hood, A-C	Decal, 185	70262838V
RH Hood, A-C	Decal, 185	70262839V
LH Hood, Model Designation	Decal, 185	70262840V
RH Hood, Model Designation	Decal, 185	70262841V
PTO Warning	Decal	70271600V
PTO Guard	Decal	70271602V



70255293V

Decals, Decal Kits

AESTHETICS

Description	Component(s)	Part No.
180, 185 CONTINUED		
Decal Kit 180 - (Prior to SN 12800) (Prior to SN 15272)	Warning Warning Injection Pump Engine Oil Pressure LH Hood, Model Designation RH Hood, Model Designation PTO Guard, 2 Speed Throttle Ether Start Instructions Shift Pattern Dismounting Warning, Towing Traction Booster Position Control Hydraulic Position Controls PTO Warning Drawbar Instructions LH Hood RH Hood Warning A-C Emblem	70249664V
Decal Kit 185	Injection Pump Engine Oil Pressure RH Hood, Model Designation LH Hood, Model Designation PTO Guard, 2 Speed A-C Logo, Grille Throttle Shift Pattern Dismounting Instructions Warning, Towing Warning, Maximum Weight Traction Booster Position Control Patent PTO Warning LH Hood, A-C RH Hood, A-C Drawbar Instructions Warning Warning, Keep Guards in Place Warning, On Protective Frame Warning, Fasten Seat Belts	70255350V
180, 185 (EFF. SN 12800) (EFF. SN 15272)		
Engine Oil Pressure	Decal	70240646V
Position Control	Decal	70242246V
Traction Booster	Decal	70242249V
Ether Start Instructions	Decal	70242583V



Decals, Decal Kits

AESTHETICS

Description	Component(s)	Part No.
180, 185 (EFF. SN 12800) (EFF. SN 15272) CONTINUED		
Air Cleaner Instructions	Decal	70249908V
Throttle	Decal	70254705V
A-C Logo, Hood	Decal	70255293V
Injection Pump	Decal	70255619V
Piston Control	Decal	70255679V
Drawbar Instructions	Decal	70256569V
Maximum Weight Limit	Decal	70261549V
Shift Pattern	Decal	70261555V
LH Hood, A-C	Decal	70262838V
RH Hood, A-C	Decal	70262839V
LH Hood, Model Designation	Decal	70262840V
RH Hood, Model Designation	Decal	70262841V
PTO Warning	Decal	70271600V
PTO Guard	Decal	70271602V
Safety	Decal	70273992V
Warning	Decal	70263529V
Warning	Decal	70273992V
180, 185 (EFF. SN 12800) (EFF. SN 15272)		
Decal Kit		70261562V
	Injection Pump	
	Engine Oil Pressure	
	LH Hood, Model Designation	
	RH Hood, Model Designation	
	PTO Guard	
	A-C Logo, Hood	
	Throttle	
	Shift Pattern	
	Maximum Weight Limit	
	Position Control	
	Traction Booster	
	LH Hood, A-C	
	RH Hood, A-C	
	PTO Warning	
	Warning	
	Warning	
190, 190XT, 190XT III		
RH Hood, A-C	Decal, 190	70249055V
LH Hood, A-C	Decal, 190	70249056V
LH Hood, Model Designation	Decal, 190	70250605V
RH Hood, Model Designation	Decal, 190	70250606V
Shift Pattern	Decal	70256881V
Air Cleaner Instructions	Decal	70235896V
Air Cleaner Instructions	Decal	70239522V
Ether Start Instructions	Decal	70242583V
Trademark	Decal	70924243V
“XT”	Decal	70244573V
Position Control	Decal	70243380V
Traction Booster	Decal	70243379V
“Diesel”	Decal	70243481V
“Landhandler”	Decal	70255294V

ALLIS-CHALMERS

70249055V

ONE-NINETY

70250606V

Decals, Decal Kits

AESTHETICS

Description	Component(s)	Part No.
190, 190XT, 190XT III CONTINUED		
Engine Oil Pressure	Decal	70240646V
Steering Wheel & Choke	Decal	70243290V
Steering Wheel & Injection Pump	Decal	70243289V
PTO Clutch & Brake	Decal	70257708V
A-C, Rear Fuel Tank	Decal	70243073V
Snap Coupler	Decal	70226684V
Drawbar Instructions	Decal	70256569V
Air Cleaner Instructions	Decal	70249908V
Caution	Decal	70273992V
Decal Kit		70254673V



- RH Hood, A-C
- LH Hood, A-C
- LH Hood, Model Designation, One-Ninety
- RH Hood, Model Designation, One-Ninety
- Caution
- Shift Pattern
- Air Cleaner Instructions
- Air Cleaner Instructions
- Trademark
- “XT”
- Position Control
- Traction Booster
- Engine Oil Pressure
- Steering Wheel & Choke
- Steering Wheel & Injection Pump
- PTO Clutch & Brake
- Snap Coupler
- Drawbar Instructions
- Caution
- Warning

200		
Air Cleaner Instructions	Decal	70256564V
A-C Logo	Decal	70255293V
“Diesel”	Decal	70243481V
Drawbar Instructions	Decal	70256569V
Ether Start	Decal	70242583V
Air Cleaner Instructions	Decal	70239522V
Engine Oil Pressure	Decal	70240646V
Steering Wheel & Injection Pump	Decal	70243289V
Steering Wheel & Choke	Decal	70243290V
Position Control	Decal	70243380V
RH Hood, Model Designation	Decal	70256272V
LH Hood, Model Designation	Decal	70256273V
Shift Pattern & Speeds	Decal	70256881V
PTO Clutch & Brake	Decal	70257708V
Warning, PTO	Decal	70271600V
PTO Guard	Decal	70271602V
Safety	Decal	70273992V
A-C Logo	Decal	70924244V

ALLIS-CHALMERS

70255273V

200

70256273V

Decals, Decal Kits

Description	Component(s)	Part No.
200 CONTINUED		
Decal Kit		70256347V
	RH Hood, Model Designation	
	LH Hood, Model Designation	
	LH Hood, A-C	
	RH Hood, A-C	
	Caution	
	Shift Pattern	
	Air Cleaner Instructions	
	A-C Logo	
	Position Control	
	Engine Oil Pressure	
	Steering Wheel & Injection Pump	
	Steering Wheel & Choke	
	PTO Clutch & Brake	
	Warning	
	Drawbar Instructions	
	PTO, 2 Speed	
	PTO Warning	
210		
“Landhandler”	Decal	70255294V
Drawbar Instructions	Decal	70256569V
Ether Start	Decal	70242583V
LH Hood, A-C	Decal	70249055V
RH Hood, A-C	Decal	70249056V
Allis-Chalmers, Rear Fuel Tank	Decal	70243073V
Shift Pattern	Decal	70240645V
Engine Oil Pressure	Decal	70240646V
Traction Booster	Decal	70242249V
Steering Wheel & Injection Pump	Decal	70243289V
Air Cleaner Instructions	Decal	70249908V
Transmission, Oil Check	Decal	70255056V
Piston Control	Decal	70255679V
Range Shift	Decal	70255750V
PTO Clutch	Decal	70257708V
Warning, PTO	Decal	70271600V
Safety	Decal	70273992V
A-C Logo, Seat	Decal	70924244V
220, 220 FWA		
“Landhandler”	Decal	70255294V
Allis-Chalmers, Rear Fuel Tank	Decal	70243073V
Drawbar Instructions	Decal	70256569V
Ether Start	Decal	70242583V
RH Hood	Decal	70249055V
LH Hood	Decal	70249056V
LH Hood	Decal	70253601V
RH Hood	Decal	70253602V
Shift Pattern	Decal	70240645V
Engine Oil Pressure	Decal	70240646V
Position Control	Decal	70242246V
Traction Booster	Decal	70242249V

Decals, Decal Kits

AESTHETICS

Description	Component(s)	Part No.
220, 220 FWA CONTINUED		
Steering Wheel & Injection Pump	Decal	70243289V
Air Cleaner Instructions	Decal	70249908V
Transmission, Oil Check	Decal	70255056V
Front Wheel Assist (FWA)	Decal	70255063V
Piston Control	Decal	70255679V
Range Shift	Decal	70255750V
PTO Clutch	Decal	70257708V
Warning, PTO	Decal	70271600V
Safety	Decal	70273992V
A-C Logo	Decal	70924244V
Decal Kit		70254137V

ALLIS-CHALMERS

TWO-TWENTY

LANDHANDLER

GRILLE ASSEMBLY
8010, 8030, 8050, 8070, 4W220
Part No. 70264026V

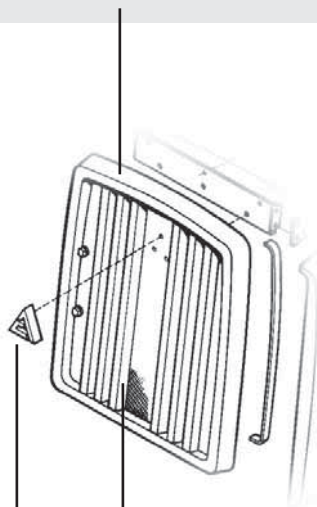

GRILLE SCREEN
Attaches to Grille Assembly
Part No. 70264126V

A-C LOGO EMBLEM
Mounts on Grille Screen
Part No. 70261587V
Use 3 of Screw Part No. 70934720
to mount Emblem onto the Grille.



- Piston Control
- Shift Pattern
- Engine Oil Pressure
- PTO Clutch
- Warning, PTO
- Safety
- LH Hood, Model Designation
- RH Hood, Model Designation
- Steering Wheel & Injection Pump
- Position Control
- Traction Booster
- Transmission, Oil Check
- Ether Start
- A-C Logo
- RH Hood, A-C
- LH Hood, A-C
- Range Shift
- "Landhandler"

4W220

Check & Fill Procedure, Rear Housing	Decal	70268031V
Patent	Decal	70268404V
Fan Warning	Decal	70271163V
PTO Guard (1000 RPM)	Decal	70271601V
Safety	Decal	70273992V
Deutz-Allis (Must Order Two)	Decal	70274460V
A-C Logo	Emblem Mounts on Grille	70261587V
Grille Assembly	Grille Frame	70264026V
Grille Screen	Attaches to Grille Assembly	70264126V

4W305

Check & Fill Procedure, Rear Housing	Decal	70268031V
Patent	Decal	70268404V
Fan Warning	Decal	70271163V
PTO Guard (1000 RPM)	Decal	70271601V
Safety	Decal	70273992V
A-C Logo	Emblem Mounts on Grille	70261587V

5000, 6000 SERIES

Allis-Chalmers Logo (Grille)	Decal, 5020, 5020 FWD, 5030, 5040, 5045, 5050, 6040	70267845V
Mounting Plate (Grille)	Emblem, 5045, 5050, 6060, 6070, 6080	70261587V

Decals, Decal Kits

Description	Component(s)	Part No.
7000 (EFF. SN 8001)		
Drawbar Instructions	Decal	70256569V
LH Hood, Model Designation	Decal, 7000	70262345V
RH Hood, Model Designation	Decal, 7000	70262344V
RH Hood	Decal	70260200V
LH Hood	Decal	70260201V
A-C Logo	Decal	70267845V
Fuel Shut-Off & Light Switch	Decal	70258679V
Patent	Decal	70268404V
Air Conditioner	Decal	70268454V
Heater	Decal	70268455V
Warning	Decal	70271163V
PTO Guard (1000 RPM)	Decal	70271601V
PTO Guard	Decal	70271602V
Safety	Decal	70273992V
A-C Logo	Emblem Mounts on Grille	70261587V
Governor Control & Key Switch	Decal	70271598V
7000 (PRIOR TO SN 8001)		
Drawbar Instructions	Decal	70256569V
Fuel Shut-Off & Light Switch	Decal	70258679V
RH Hood, Model Designation	Decal, 7000	70260200V
LH Hood, Model Designation	Decal, 7000	70260201V
Patent	Decal	70268404V
Air Conditioner	Decal	70268454V
Heater	Decal	70268455V
Warning	Decal	70271163V
Governor Control & Key Switch	Decal	70271598V
PTO Guard (1000 RPM)	Decal	70271601V
PTO Guard	Decal	70271602V
Safety	Decal	70273992V
A-C Logo	Emblem Mounts on Grille	70261587V
7010, 7020		
LH Hood, Model Designation	Decal, 7010	70271987V
RH Hood, Model Designation	Decal, 7010	70271986V
LH Hood, Model Designation	Decal, 7020	70262347V
RH Hood, Model Designation	Decal, 7020	70262346V
Power Shift	Decal	70269990V
Safety	Decal	70273992V
A-C Logo	Emblem Mounts on Grille	70261587V
Warning	Decal	70271163V
Remote Mirror	Decal	70271442V
PTO Guard (1000 RPM)	Decal	70271601V
PTO Guard	Decal	70271602V
Governor Control & Key Switch	Decal	70271654V
A-C Logo	Decal	70267845V
Fuel Shut-Off & Light Switch	Decal	70258679V
20-Speed Transmission, Manual	Decal	70261306V
Shift (Power Director Tractor)	Decal	70261320V
Console, Range Shift	Decal	70262241V
Console	Decal	70262320V
Shift Pattern, 20-Speed	Decal	70262673V



70261320V

Decals, Decal Kits

AESTHETICS

Description	Component(s)	Part No.
7010, 7020 CONTINUED		
Power Shift 8 Speed	Decal	70262674V
Transmission Oil Check	Decal	70262676V
Shift Speed (16-Speed)	Decal	70262679V
Remote Flow	Decal	70265980V
Check & Fill Procedure, Rear Housing	Decal	70268031V
Patent	Decal	70268404V
Air Conditioner	Decal	70268454V
Heater	Decal	70268455V
Air Cleaner, Non-Aspirated	Decal	70269278V
Console, Range Shift (Power Shift)	Decal	70269947V
Decal Kit		70262677V
	Air Cleaner Instructions	
	Power Shift & Range Shift Pattern	
	Governor Control & Key Switch	
	Console, Power Director Tractor	
	Console	
(Prior to SN 2027)	Trademark	
	Light Switch & Fuel Shut Off	
	Remote Flow	
	PTO Guard (540 & 1000 RPM)	
	PTO Guard (1000 RPM)	
	Shift Pattern, Power Director Tractor, 20-Speed	
	Check & Fill	
	Transmission Oil Check	
	Patent	
	Air Conditioning	
	Heater	
	Power - Range Shift	
	Fan Warning	
	Shift Pattern, Power Director Tractor, 16-Speed	
	Shift Decal, Power Director Tractor, 20-Speed	
	Shift Decal, Power Director Tractor, 16-Speed	
	Remote Mirror	
	Warning	
	Warning	
	Seat Adjustment	
	Antifreeze	
7030		
Drawbar Instructions	Decal	70256569V
LH Hood, Model Designation	Decal, 7030	70268113V
RH Hood, Model Designation	Decal, 7030	70268114V
Ether Start	Decal	70242583V
A-C Logo	Decal	70267845V
Transmission Oil Check	Decal	70262676V
Remote Flow	Decal	70265980V
Check & Fill Procedure, Rear Housing	Decal	70268031V
Air Conditioner	Decal	70268454V
Heater	Decal	70268455V
PTO Guard	Decal	70271602V

Decals, Decal Kits

Description	Component(s)	Part No.
7030 CONTINUED		
Safety	Decal	70273992V
A-C Logo	Emblem Mounts on Grille	70261587V
PTO Guard (1000 RPM)	Decal	70271601V
7040		
A-C Logo	Decal	70267845V
Drawbar Instructions	Decal	70256569V
Transmission Oil Check	Decal	70262676V
Shift Pattern (Power Shift Tractor)	Decal	70265668V
Remote Flow	Decal	70265980V
Check & Fill Procedure, Rear Housing	Decal	70268031V
Patent	Decal	70268404V
Air Conditioner	Decal	70268454V
Heater	Decal	70268455V
Air Cleaner, Non-Aspirated	Decal	70269278V
RH Hood, Model Designation	Decal, 7040	70269282V
LH Hood, Model Designation	Decal, 7040	70269283V
Console, Range Shift (Power Shift)	Decal	70269947V
Power Shift	Decal	70269990V
Governor Control & Key Switch	Decal, w/Air Heater	70271598V
PTO Guard	Decal	70271602V
Governor Control & Key Switch	Decal w/Ether Start	70271654V
7045		
Drawbar Instructions	Decal	70256569V
A-C Logo	Decal	70267845V
Fuel Shut-Off & Light Switch	Decal	70258679V
20-Speed Transmission, Manual	Decal	70261306V
Shift (Power Director Tractor)	Decal	70261320V
Console, Range Shift	Decal	70262241V
Console	Decal	70262320V
RH Hood, Model Designation	Decal, 7045	70262348V
LH Hood, Model Designation	Decal, 7045	70262349V
Shift Pattern (Power Director Tractor)	Decal	70262672V
Power Range Shift	Decal	70262675V
Transmission Oil Check	Decal	70262676V
Remote Flow	Decal	70265980V
Check & Fill Procedure, Rear Housing	Decal	70268031V
Patent	Decal	70268404V
Air Conditioner	Decal	70268454V
Heater	Decal	70268455V
Air Cleaner, Non-Aspirated	Decal	70269278V
Console, Range Shift (Power Shift)	Decal	70269947V
Power Shift	Decal	70269990V
Warning	Decal	70271163V
Remote Mirror	Decal	70271442V
Governor Control & Key Switch	Decal, w/Air Heater	70271598V
PTO Guard (1000 RPM)	Decal	70271601V
PTO Guard	Decal	70271602V
Governor Control & Key Switch	Decal, w/Ether Start	70271654V
Safety	Decal	70273992V
A-C Logo	Emblem Mounts on Grille	70261587V

Description	Component(s)	Part No.
7045 CONTINUED		
Decal Kit		70262677V
	Air Cleaner Instructions	
	Power Shift & Range Shift Pattern	
	Governor Control & Key Switch	
	Console Decal, Power Director Tractor	
	Console	
(Prior to SN 2027)	Trademark	
	Light Switch & Fuel Shut-Off	
	Remote Flow	
	PTO Guard (540 & 1000 RPM)	
	PTO Guard (1000 RPM)	
	Shift Pattern, Power Director Tractor, 20-Speed	
	Check & Fill	
	Transmission Oil Check	
	Patent	
	Air Conditioning	
	Heater	
	Power-Range Shift	
	Fan Warning	
	Shift Pattern, Power Director Tractor, 16-Speed	
	Shift Decal, Power Director Tractor, 20-Speed	
	Shift Decal, Power Director Tractor, 16-Speed	
	Remote Mirror	
	Warning	
	Warning	
	Seat Adjustment	
	Antifreeze	
7050		
Drawbar Instructions	Decal	70256569V
Ether Start	Decal	70242583V
LH Hood, A-C	Decal	70268115V
RH Hood, A-C	Decal	70268116V
A-C Logo	Decal	70267845V
Air Filter Instructions	Decal	70242583V
Drawbar Instructions	Decal	70256569V
Transmission Oil Check	Decal	70262676V
Remote Flow	Decal	70265980V
Check & Fill Procedure, Rear Housing	Decal	70268031V
LH Hood, Model Designation	Decal, 7050	70268115V
RH Hood, Model Designation	Decal, 7050	70268116V
Air Conditioner	Decal	70268454V
Heater	Decal	70268455V
PTO Guard (1000 RPM)	Decal	70271601V
PTO Guard	Decal	70271602V
Safety	Decal	70273992V
A-C Logo	Emblem Mounts on Grille	70261587V

Decals, Decal Kits

Description	Component(s)	Part No.
7060		
Drawbar Instructions	Decal	70256569V
RH Hood	Decal	70269282V
LH Hood	Decal	70269283V
Ether Start	Decal	70242583V
A-C Logo	Decal	70267845V
Fuel Shut-Off & Light Switch	Decal	70258679V
Manual Transmission, 20-Speed	Decal	70261306V
Console, Range Shift	Decal	70262241V
Console	Decal	70262320V
RH Hood, Model Designation	Decal, 7060	70262350V
LH Hood, Model Designation	Decal, 7060	70262351V
Shift Pattern (Power Director)	Decal	70262672V
Power Range Shift	Decal	70262675V
Transmission Oil Check	Decal	70262676V
Shift Pattern (Power Shift)	Decal	70265671V
Remote Flow	Decal	70265980V
Check & Fill Procedure, Rear Housing	Decal	70268031V
Patent	Decal	70268404V
Air Conditioner	Decal	70268454V
Heater	Decal	70268455V
Console, Range Shift (Power Shift)	Decal	70269947V
Power Shift	Decal	70269990V
Warning	Decal	70271163V
Remote Mirror	Decal	70271442V
Governor Control & Key Switch	Decal, w/Air Heater	70271598V
PTO Guard (1000 RPM)	Decal	70271601V
PTO Guard	Decal	70271602V
Governor Control & Key Switch	Decal, w/Ether Start	70271654V
Safety	Decal	70273992V
A-C Logo	Emblem Mounts on Grille	70261587V
7080		
Drawbar Instructions	Decal	70256569V
A-C Logo	Decal	70267845V
Fuel Shut-Off & Light Switch	Decal	70258679V
Manual Transmission, 20-Speed	Decal	70261306V
Console, Range Shift	Decal	70262241V
Console	Decal	70262320V
RH Hood, Model Designation	Decal, 7080 (Eff. SN 3001)	70262352V
LH Hood, Model Designation	Decal, 7080 (Eff. SN 3001)	70262353V
Transmission Oil Check	Decal	70262676V
Remote Flow	Decal	70265980V
Check & Fill Procedure, Rear Housing	Decal	70268031V
LH Hood, Model Designation	Decal, 7080 (Prior to SN 3001)	70268111V
RH Hood, Model Designation	Decal, 7080 (Prior to SN 3001)	70268112V
Patent	Decal	70268404V
Air Conditioner	Decal	70268454V
Heater	Decal	70268455V
Warning	Decal	70271163V
Remote Mirror	Decal	70271442V

power shift		range shift	
gear	slow	fast	
6	7.1	19.1	
5	5.6	15.1	
4	4.5	12.2	
3	3.6	9.7	
2	2.6	7.0	
1	1.9	5.1	
R	3.1	8.2	

m.p.h. @ 2300 eng. r.p.m. with 18.4 x 38 tires

70265671V

Decals, Decal Kits

GRILLE ASSEMBLY

8010, 8030, 8050, 8070, 4W220
Part No. 70264026V

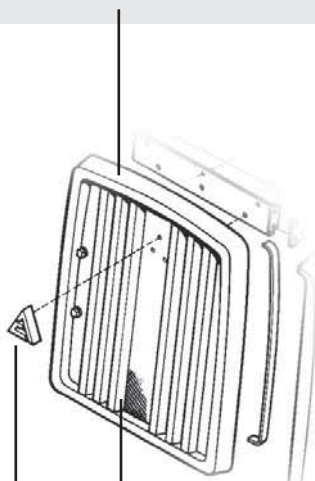

GRILLE SCREEN

Attaches to Grille Assembly
Part No. 70264126V

A-C LOGO EMBLEM

Mounts on Grille Screen
Part No. 70261587V

Use 3 of Screw Part No. 70934720
to mount Emblem onto the Grille.

ALLIS-CHALMERS 8010

70264840V

Description	Component(s)	Part No.
7080 CONTINUED		
PTO Guard (1000 RPM)	Decal	70271601V
PTO Guard	Decal	70271602V
Governor Control & Key Switch	Decal	70271654V
Safety	Decal	70273992V
7580		
A-C Logo	Emblem Mounts on Grille	70261587V
A-C Logo	Decal	70267845V
Fuel Shut-Off & Light Switch	Decal	70258679V
Manual Transmission, 20-Speed	Decal	70261306V
Console	Decal	70262320V
Check & Fill Procedure, Rear Housing	Decal	70268031V
Patent	Decal	70268404V
Air Conditioner	Decal	70268454V
Heater	Decal	70268455V
Warning	Decal	70271163V
Remote Mirror	Decal	70271442V
PTO Guard (1000 RPM)	Decal	70271601V
Governor Control & Key Switch	Decal	70271654V
Safety	Decal	70273992V
8010		
Deutz-Allis (Must Order Two)	Decal	70274460V
Power Shift	Decal	70269990V
Power Shift 8 Speed	Decal	70262674V
LH Hood, Model Designation	Decal, Allis-Chalmers, 8010	70264839V
RH Hood, Model Designation	Decal, Allis-Chalmers, 8010	70264840V
Remote Flow	Decal	70265980V
Patent	Decal	70268404V
Air Cleaner, Non-Aspirated	Decal	70269278V
Power Shift	Decal	70269990V
Warning	Decal	70271163V
PTO Guard (1000 RPM)	Decal	70271601V
PTO Guard	Decal	70271602V
Safety	Decal	70273992V
A-C Logo	Emblem Mounts on Grille	70261587V
Grille Assembly	Grille Frame	70264026V
Grille Screen	Attaches to Grille Assembly	70264126V
8030		
Power Shift	Decal	70269990V
LH Hood, Model Designation	Decal, Allis-Chalmers, 8030	70264841V
RH Hood, Model Designation	Decal, Allis-Chalmers, 8030	70264842V
Remote Flow	Decal	70265980V
Patent	Decal	70268404V
Power Shift	Decal	70269990V
Warning	Decal	70271163V
PTO Guard (1000 RPM)	Decal	70271601V
PTO Guard	Decal	70271602V
Safety	Decal	70273992V

Decals, Decal Kits

Description	Component(s)	Part No.
8030 CONTINUED		
Deutz-Allis (Must Order Two)	Decal	70274460V
A-C Logo	Emblem Mounts on Grille	70261587V
Grille Assembly	Grille Frame	70264026V
Grille Screen	Attaches to Grille Assembly	70264126V
8050		
Deutz-Allis (Must Order Two)	Decal	70274460V
Power Shift	Decal	70269990V
LH Hood, Model Designation	Decal, Allis-Chalmers, 8050	70264843V
RH Hood, Model Designation	Decal, Allis-Chalmers, 8050	70264844V
Remote Flow	Decal	70265980V
Patent	Decal	70268404V
Power Shift	Decal	70269990V
Warning	Decal	70271163V
PTO Guard (1000 RPM)	Decal	70271601V
PTO Guard	Decal	70271602V
Safety	Decal	70273992V
A-C Logo	Emblem Mounts on Grille	70261587V
Grille Assembly	Grille Frame	70264026V
Grille Screen	Attaches to Grille Assembly	70264126V
8070		
Deutz-Allis (Must Order Two)	Decal	70274460V
Power Shift	Decal	70269990V
LH Hood, Model Designation	Decal, Allis-Chalmers, 8070	70264845V
RH Hood, Model Designation	Decal, Allis-Chalmers, 8070	70264846V
Remote Flow	Decal	70265980V
Patent	Decal	70268404V
Power Shift	Decal	70269990V
Warning	Decal	70271163V
PTO Guard (1000 RPM)	Decal	70271601V
PTO Guard	Decal	70271602V
Safety	Decal	70273992V
A-C Logo	Emblem Mounts on Grille	70261587V
Grille Assembly	Grille Frame	70264026V
Grille Screen	Attaches to Grille Assembly	70264126V

DEUTZ-ALLIS

70274460V

Paint Application Guide

Use this Machine Locator to identify key paint locations on your tractor: Trim, Sheet Metal, Chassis, Wheels, and Center Wheel Dish/Disc.

TRIM: Grille and cab roof

SHEET METAL: Hood and side panels

DISH/DISC: Inside portion of the wheel assembly

CHASSIS: Frame portion of the machine

WHEELS: Outside portion of the rim

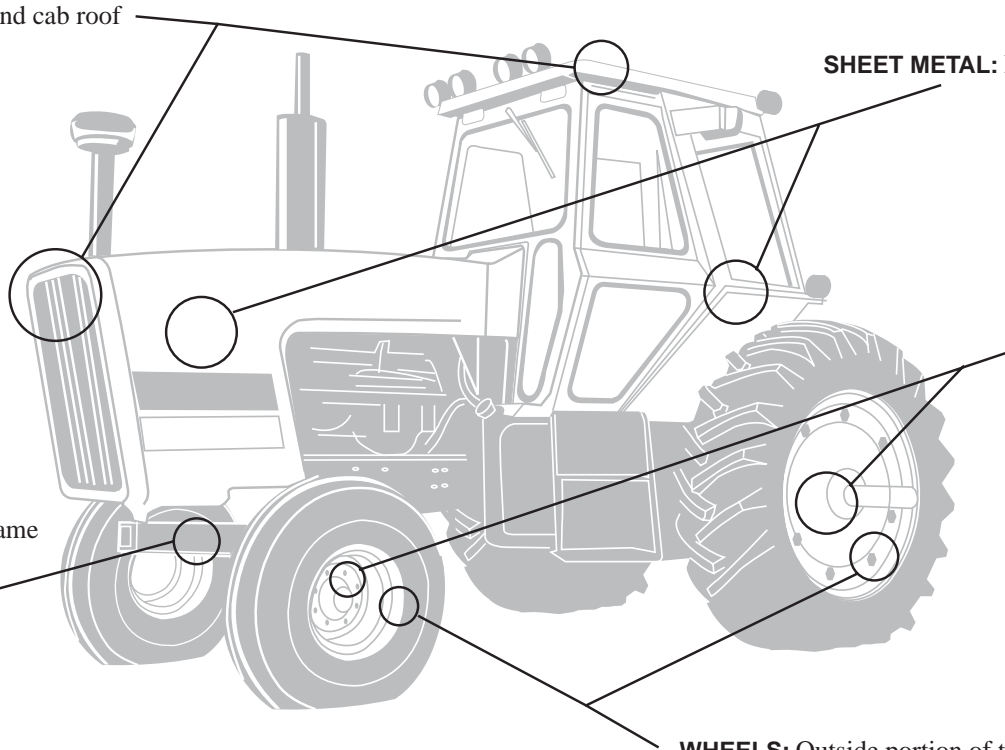

ALLIS-CHALMERS, DEUTZ-ALLIS

Make & Years	Sheet Metal	Wheels*	Dish/Disc*	Chassis*	Trim*
Tractors					
A-C Prior to 1930	Dark Green	Dk. Green or Red	DNA	Dk. Green	Various
A-C 1929-1960	Per. Orange #1	Various	Various	Per. Orange #1	Various
A-C 1961-1977	Per. Orange #2	Various	Various	Per. Orange #2 or Maroon	Various
A-C 1978-1985	Corp. Orange	Cloud White	Various	Blk. Semi-gloss	Various
D-A 1985-1991	Spring Green	Pearl Gray	Pearl Gray	Gun Metal Blue	Various
D-A 1986-1990	Spring Green	Various	Various	Gun Metal Blue	Various

COLOR BY MACHINE

Make & Years	Sheet Metal	Wheels*	Dish/Disc*	Chassis	Trim*
Allis-Chalmers Prior to 1930					
10-18, 12-20, 15-25	Dk. Green	Dk. Green, Red	DNA	Dk. Green	Yellow, Orange (Pinstripes)
18-30, 20-35, EK	Dk. Green	Dk. Green, Red	DNA	Dk. Green	Yellow, Orange (Pinstripes)
Allis-Chalmers 1929 through 1960					
E25-40	Per. Orange #1	Per. Orange #1	Per. Orange #1	Per. Orange #1	Cream (Grille)
United, U, All-Crop, UC	Per. Orange #1	Per. Orange #1, Blk.	Per. Orange #1, Blk.	Per. Orange #1	Per. Orange #1
A	Per. Orange #1	Per. Orange #1, Blk.	Blk.	Per. Orange #1	Per. Orange #1
B	Per. Orange #1	Per. Orange #1, Blk.	Blk., Galv., Orange #1	Per. Orange #1	Per. Orange #1
C	Per. Orange #1	Per. Orange #1	Galv., Orange #1	Per. Orange #1	Per. Orange #1
CA	Per. Orange #1	Per. Orange #1	Per. Orange #1, Alum.	Per. Orange #1	Per. Orange #1
G	Per. Orange #1	Per. Orange #1	Silver	Per. Orange #1	Per. Orange #1
RC	Per. Orange #1	Per. Orange #1	Per. Orange #1, Blk.	Per. Orange #1	Per. Orange #1
WC	Per. Orange #1	Per. Orange #1	Blk., Dk. Green, Orange #1	Per. Orange #1	Per. Orange #1
WF	Per. Orange #1	Per. Orange #1, Blk.	Per. Orange #1, Blk.	Per. Orange #1	Per. Orange #1
WD	Per. Orange #1	Per. Orange #1	Per. Orange #1, Alum.	Per. Orange #1	Per. Orange #1
WD45	Per. Orange #1	Per. Orange #1	Per. Orange #1, Alum.	Per. Orange #1	Per. Orange #1

*Where multiple colors are listed, only one color was used on any specific tractor.

DNA-Did Not Apply

Paint Application Guide



COLOR BY MACHINE CONTINUED

Make & Years	Sheet Metal	Wheels*	Dish/Disc*	Chassis	Trim*
Allis-Chalmers 1929 through 1960 Continued					
Crawlers - M, K, L, S	Per. Orange #1	DNA	DNA	Per. Orange #1	Per. Orange #1
D10, D12	Per. Orange #1	Per. Orange #1	Per. Orange #1, Alum.	Per. Orange #1	Alum. w/Blk Trim (Grille)
D14, D17	Per. Orange #1	Per. Orange #1	Per. Orange #1, Alum.	Per. Orange #1	Per. Orange #1, Alum. (Grille)
Allis-Chalmers 1961 through 1977					
D10, D12	Per. Orange #2	Cream, Per. #2	Cream, Alum.	Per. Orange #2	Cream (Grille)
D15, D17, D19	Per. Orange #2	Cream, Per. #2	Cream, Alum.	Per. Orange #2	Cream (Grille)
D21	Per. Orange #2	Cream, Per. #2	Cream, Alum.	Per. Orange #2	Cream, Chrome (Grille)
160	Per. Orange #2	Cream, Per. #2	Cream	Per. Orange #2	Per. Orange #2
170, 175	Per. Orange #2	Cream	Cream, Alum.	Per. Orange #2	Per. Orange #2
180, 185	Per. Orange #2	Cream	Cream, Alum.	Per. Orange #2	Per. Orange #2
190, 190XT	Per. Orange #2	Cream	Cream, Alum.	Per. Orange #2	Per. Orange #2
200, 210, 220	Per. Orange #2	Cream	Cream, Alum.	Per. Orange #2	Per. Orange #2/Cloud Wht. (Roof)
440	Per. Orange #2	Cream	Cream	Per. Orange #2	Cream (Roof)
6040	Per. Orange #2	Cream	Cream, Alum.	Maroon	Blk. (Grille)
5040	Per. Orange #2	Cream	Cream, Alum.	Maroon	Blk. (Grille)
7000	Per. Orange #2	Cream	Cream, Alum.	Maroon	Cream (Roof)
7030	Per. Orange #2	Cream	Cream, Alum.	Maroon	Cream (Roof)
7040	Per. Orange #2	Cream	Cream, Alum.	Maroon	Cream (Roof)
7050	Per. Orange #2	Cream	Cream, Alum.	Maroon	Cream (Roof)
7060	Per. Orange #2	Cream	Cream, Alum.	Maroon	Cream (Roof)
7080	Per. Orange #2	Cream	Cream, Alum.	Maroon	Cream (Roof)
7580	Per. Orange #2	Cream	Cream, Alum.	Maroon	Cream (Roof)
Allis-Chalmers 1978 through 1985					
5010, 5020, 5030	Corp. Orange	Cloud White	Cloud Wht.	Blk. Semi-Gloss	Blk. Gloss (Trim)
5040	Corp. Orange	Cloud White	Cloud Wht., Alum.	Maroon	Blk. Gloss (Trim)
5045	Corp. Orange	Cloud White	Cloud Wht., Alum.	Blk. Semi-Gloss	Blk. Gloss (Trim)
5050	Corp. Orange	Cloud White	Cloud Wht., Alum.	Maroon, Blk (1981+)	Blk. Gloss (Trim)
6140	Corp. Orange	Cloud White	Cloud Wht., Alum.	Blk. Semi-Gloss	Blk. Gloss (Trim)
6060, 6070, 6080	Corp. Orange	Cloud White	Cloud Wht., Alum.	Blk. Semi-Gloss	Cloud Wht. (Canopy)
7000	Corp. Orange	Cloud White	Cloud Wht., Alum.	Blk. Semi-Gloss	Cloud Wht. (Roof)
7010, 7020	Corp. Orange	Cloud White	Cloud Wht., Alum.	Blk. Semi-Gloss	Cloud Wht. (Roof)
7045, 7060, 7080	Corp. Orange	Cloud White	Cloud Wht., Alum.	Blk. Semi-Gloss	Cloud Wht. (Roof)
7580, 8550	Corp. Orange	Cloud White	Cloud Wht., Alum.	Blk. Semi-Gloss	Cloud Wht. (Roof)
8010, 8030, 8050, 8070	Corp. Orange	Cloud White	Cloud Wht., Alum.	Blk. Semi-Gloss	Blk. (Grille)
4W220, 4W305	Corp. Orange	Cloud White	Cloud Wht., Alum.	Blk. Semi-Gloss	Blk. (Grille)
Deutz-Allis 1985 through 1991					
5215H & S (Compact)	Spring Green	Pearl Gray	Pearl Gray	Gun Metal Blue	DNA
5220H & S (Compact)	Spring Green	Pearl Gray	Pearl Gray	Gun Metal Blue	DNA
5230 (Compact)	Spring Green	Pearl Gray	Pearl Gray	Gun Metal Blue	DNA
6035	Spring Green	Pearl Gray	Pearl Gray	Gun Metal Blue	DNA
6150	Argentine Green	Pearl Gray	Pearl Gray	Gun Metal Blue	DNA
6240, 6250, 6260	Spring Green	Pearl Gray	Pearl Gray	Gun Metal Blue	DNA
6265, 6275	Spring Green	Pearl Gray	Pearl Gray	Gun Metal Blue	DNA
7085, 7110, 7120, 7145	Spring Green	Pearl Gray	Pearl Gray	Gun Metal Blue	DNA
9150, 9170, 9190	Spring Green	Gray, Gun Metal Blue	Argent Silver	Gun Metal Blue	DNA

*Where multiple colors are listed, only one color was used on any specific tractor.

Paint - Allis-Chalmers, AGCO-Allis, Deutz-Allis

- Original Equipment Colors
- Original Equipment Quality
- Fast-Drying Formulation

Most colors available in quarts, aerosols and gallons

ALLIS-CHALMERS USED THREE DIFFERENT SHADES OF ORANGE OVER THE YEARS

PERSIAN ORANGE #1
1929 - 1960



PERSIAN ORANGE #2
1961 - 1977



CORPORATE ORANGE
1978 - 1985



GUN METAL BLUE



SPRING GREEN



MAROON



CREAM

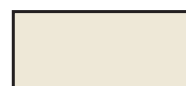

PRIME FIRST

It's the foundation for a sound paint job.

WHY PRIME?

- Primer seals the surface to provide a uniform, even gloss finish.
- Primer penetrates and bonds to allow for best topcoat adhesion.
- Primer provides the maximum rust resistance for maximizing the life of the finish coat.

Paint Color	Size	Part No.
Aluminum	Aerosol	79014652
Aluminum	Quart	79014795
Argentine Green	Aerosol	79011999
Black	Aerosol	79014653
Black	Quart	79014797
Black	Gallon	79014796
Black Semi-Gloss	Aerosol	79014654
Black Semi-Gloss	Quart	79014798
Cloud White	Aerosol	79014655
Corporate Orange	Aerosol	79014656
Corporate Orange	Quart	79014782
Corporate Orange	Gallon	79014781
Corporate Silver	Aerosol	79014803
Corporate Silver	Quart	79014802
Corporate Silver	Gallon	79014801
Corporate Wheel Gray	Aerosol	79016947
Corporate Wheel Gray	Quart	79016946
Cream	Aerosol	79014657
Cream	Quart	79014790
Gray Semi-Gloss	Aerosol	79014658
Gun Metal Blue	Aerosol	79014659
Gun Metal Blue	Quart	79014788
Gun Metal Blue	Gallon	79014787
Maroon	Aerosol	79014660
New White	Aerosol	79014661
New White	Quart	79014793
Orange	Quart	79015773
Pearl Gray	Aerosol	79014663
Pearl Gray	Quart	79014800
Persian Orange #2	Aerosol	79014664
Persian Orange #2	Quart	79014785
Persian Orange #1	Quart	79021641
Saddle Brown	Aerosol	79017235
Spring Green	Aerosol	79014665
Spring Green	Quart	79014784
Spring Green	Gallon	79014783
MUFFLER PAINT		
Hi-Temp Aluminum	Aerosol	79015023
Hi-Temp Black	Aerosol	79014480
THINNER		
Thinner	Gallon	79015024
PRIMER		
Red Oxide Primer	Aerosol	1904943M1
Red Oxide Primer	Quart	1904945M1
Gray Primer	Aerosol	79014483
Gray Primer	Quart	79014481
Gray Primer	Gallon	79014482

NOTE TO DEALER: Order Paint, Primer and Thinner on AGCO Paint Direct-Ship Promo 265.

Cab Interior



Here is what you need to refurbish an A-C 8000 Series tractor cab: Cab Interior 79022935V; Headliner 79022926V; Floor Mat 79022988V; and Spray Adhesive 79023004V.

Benefits of Refurbishing a Cab

- Cleaner, more comfortable work environment
- Insulates cab from noise
- Reduces vibration
- Increases resale value of used machinery

A complete cab interior kit consists of a headliner and cab upholstery.

An upholstery kit includes a headliner unless otherwise noted. *Spray adhesive is not included in kit; order separately.*

INTERIOR CAB KITS

Kit No.	MUO	No. of Pieces	Color
79022923V	A-C 200	10	Black
79022924V	A-C 210	12	Black
79022925V	A-C 440	13	Black
79022926V	Headliner; A-C 4W220, 4W305	1	Tan
79022927V*	A-C 4W220, 4W305	8	Tan
79022928V	Headliner; A-C 6060, 6070, 6080	5	Black
79022929V*	A-C 6060, 6070, 6080	5	Black
79022930V	A-C 7000 with Black Power Train	16	Black
79022931V	A-C 7000 with Maroon Power Train	10	Black
79022932V	A-C 7010, 7020, 7045, 7060, 7080 with Black Power Train	16	Black
79022933V	A-C 7010, 7020, 7045, 7060, 7080 with Maroon Power Train	10	Black
79022934V	A-C 7580, 8550	19	Black
79022926V	Headliner; A-C 8010, 8030, 8050, 8070	1	Tan
79022935V*	A-C 8010, 8030, 8050, 8070	7	Tan
79022936V	Headliner; D-A 9130, 9150, 9170, 9190	1	Gray
79022937V*	D-A 9130, 9150, 9170, 9190 with Manual Seat	19	Gray
79023031V*	D-A 9130, 9150, 9170, 9190 with Air Ride Seat	19	Gray
79022979V	A-C 170, 175, 180, 185 with Year-A-Round Cab	9	Black
79022980V	A-C 190, 200 with Year-A-Round Cab	10	Black
79022981V	Year-A-Round QT1 Cab (Various AGCO Models)	7	Black
79022982V	Hiniker Cab (Various AGCO Models)	7	Black

FLOOR MATS

Part No.	MUO	No. of Pieces	Color
79022983V	A-C 200	1	Black
79022984V	A-C 6060, 6070, 6080	1	Black
79022985V	A-C 7000	1	Black
79022986V	A-C 7010, 7020, 7030, 7040, 7045, 7060, 7080	1	Black
79022987V	A-C 7010, 7020, 7030, 7040, 7045, 7060, 7080	1	Black
79022988V	A-C 8010, 8030, 8050, 8070	1	Black

SPRAY ADHESIVE

Part No.	Description	Pack Quantity
79023003V	3M 74 Foam Fast Orange Adhesive - When sprayed on upholstery and the piece is placed into position, this adhesive allows for a little movement and dries almost immediately on contact.	12 Cans per Case
79023004V	Pro Bond Adhesive - When sprayed on upholstery and the piece is placed into position, this adhesive is more forgiving and allows for some movement before drying.	12 Cans per Case

*Cab Kit Does Not Include Headliner

Cab Glass, Gas Shocks, Wiper Blades, Wiper Motors



BEFORE

MAKE YOUR TRACTOR LOOK BRAND NEW



AFTER

CAB GLASS

Part No.	MUO	Description
4337959V	7085, DX 4.70 (Prior to Tractor SN 7434/0678, 7435/2767) 7110, DX 6.30 (Prior to Tractor SN 7438/0330, 7439/2578) 7120, DX 6.50 (Prior to Tractor SN 7440/0145, 7441/1234) 7145, DX 7.10 (Prior to Tractor SN 7642/0138, 7643/0801)	Glass, Rear



4366129V

GAS SHOCKS - DOORS AND WINDOWS

Part No.	MUO	Description
4357776V	6260, 6265, 6275, DX3.50, DX3.70, DX3.90 - Star Cab, 7085, 7110, 7120, 7145, DX7.10, DX4.70, DX6.30, DX6.50	Cab Door
4357777V	6260, 6265, 6275, DX3.50, DX3.70, DX3.90 - Star Cab	Cab Rear Window
4366129V	6250VF, DX3.30VF, 6260FV, DX3.50VF, 6275F	Cab Windshield
4366164V	6250VF, DX3.30VF, 6260FV, DX3.50VF, 6275F	Cab Door
4373763V	7085, DX4.70 (Eff. SN 7438/0263-4439/1745) (Prior to 7434/0560 - 7435/1971), 7110, DX6.30 (Eff. SN 7438/0263 - 4439/1745) (Prior to 7434/0560 - 7435/1971), 7120, DX6.50, 7145, DX7.10	Cab Door

WIPER BLADES

Part No.	MUO
1262246V	7085, 7110, 7120, 7145, DX 7.10, DX 4.70, DX6.30, DX6.50
4422321V	Star Cab: 6260, 6265, 6275, DX3.70, DX3.90



4422321V

WIPER MOTOR

Part No.	MUO
4363241V	Vario Cab: 6240, 6250, 6260, 6265, 6275, DX3.30, DX3.70, DX3.90 6260, 6265, 6275, DX3.50, DX3.70, DX3.90, 7085, 7110, 7120, 7145, DX4.70, DX6.30, DX6.50, DX7.10

Motor, Wiper Front



4363241V

Seats and Components

AESTHETICS



Deluxe Seat Backrest
70236460V



Deluxe Seat Bottom
70236461V



Deluxe Seat Assembly
70243740V

MUO	Description	OEM Part No.	Heritage Part No.
-----	-------------	--------------	-------------------

ALLIS-CHALMERS

PAN SEAT

CA, WD (Prior to SN 127007)	Shock Absorber	70222450	70222450V
WD (Eff. SN 127007), WD45, D10, D12, D14, D15, D17, D17 Series IV, D19, D21, 170, 175, 180, 185, 190, 190XT, 190XT III, 200, 210, 220, 220 FWA, 7000, 7010, 7020, 7030, 7040, 7045, 7050, 7060, 7080, 7580	Shock Absorber	70227916	70227916V
CA, G, IB, WC, WD, WD45, WF, D14 Custom, D15 Custom, D17 Custom, D19 Custom, D21 Custom, Early Series 170, 180, 185 (Prior to SN 6559), 190	Seat Pad, Regular	70204229	70204229V
	Seat Pad, Large	70231536	70231536V
A, B, C, RC	Seat Bottom, Wood Based	70205693	70205693V
	Backrest	70208664	70208664V

DELUXE SEAT

D10, D12, D14, D15, D17, D19, D21, 170 & 175, 180 & 185 (Prior SN 12800), 190, 190XT, 190XT III, 200 (Eff. SN 4001), 220, 220 FWA, 7030, 7050	Black & White, Seat Assembly, Steel Based	70243740	70243740V
	Black & White, Seat Bottom, Wood Based	70236461	70236461V
	Black & White, Backrest, Wood Based	70236460	70236460V

SUPER DELUXE SEAT

180, 185 (Prior SN 12800), 190, 190XT, 200, 210, 220, 220 FWA	Seat Bottom, Wood Based	70243515	70243515V
	Backrest, Wood Based	70243517	70243517V
	Upper Backrest, Wood Based	70256765	70256765V
	Upper Backrest, Metal Bracket	70256766	70256766V

FOLD-UP SEAT

170, 175, 180, 185 (Prior to SN 12800), 190, 190XT, 190XT III, 200 (Prior to SN 4001), 210, 220, 220 FWA, 7030, 7050 (Prior to SN 2805)	Seat Bottom, Steel Based	70256350	70256350V
	Backrest, Steel Based	70255581	70255581V
	Armrests (R and L)	70255583	70255583V

Seats and Components

AESTHETICS



Michigan Seat

70272369V



Olympic Seat

70276256V



Marathon Seat

70263357V

MUO	Description	OEM Part No.	Heritage Part No.
-----	-------------	--------------	-------------------

ALLIS-CHALMERS

MARATHON SEAT

180 (Prior to SN 12800), 185, 200 (Eff. SN 4001),	Black Vinyl Fold-Up Seat Assembly	70263357	70263357V
6060 (Prior to SN 3683), 6080 (Prior to SN 4184),	Black Vinyl Seat Cushion	70275493	70275493V
7000 Series (Prior to SN 8001), 7010, 7020, 7030,	Black Vinyl Backrest	70269926	70269926V
7040, 7045, 7050, 7060, 7080,	Armrests (R and L)	70255583	70255583V
7580 (Prior to SN 2085), 8010 (Prior to SN 1570),	LH Armrest Plate	70255585	70255585V
8030 (Prior to SN 1807), 8050 (Prior to SN 1698),	RH Armrest Plate	70255586	70255586V
8070 (Prior to SN 1348)	LH Bracket Assembly	70257491	70257491V
	RH Bracket Assembly	70257492	70257492V
	Seat Belt (Use Existing Hardware)	70271466	70271466V

MICHIGAN SEAT

6060, 6070, 6080	Black Vinyl Seat Assembly	70272369	70272369V
	Seat Belt (Use Existing Hardware)	70271466	70271466V

OLYMPIC SEAT

6060 (Eff. SN 3683), 6070, 6080 (Eff. SN 4184),	Black Vinyl Seat Assembly	70276256	70276256V
8010 (Eff. SN 1570), 8030 (Eff. SN 1807),	Seat Bottom, Black Vinyl	70272908	70272908V
8050 (Eff. SN 1698), 8070 (Eff. SN 1348),	Backrest, Black Vinyl	70272909	70272909V
4W220, 4W305	Armrests	70276257, 70276258	NA
	Shock Absorber	70263571	70263571V
	Seat Belt (Use Existing Hardware)	70271466	70271466V

NA = Not Available

Seats and Components



Seat Assembly
72100790V



Backrest
70243517V
Page 43



Seat Bottom
70243515V
Page 43

MUO	Description	OEM Part No.	Heritage Part No.
DEUTZ-ALLIS			
SEAT			
5015, 5215, 5220 Hydrostatic 5215, 5220, 5230 Synchro-Shift	Seat Assembly	72100790	72100790V
5020, 5020 FWD, 5030 (21 hp FWD Prior to SN 5020-04814, 26 hp Prior to SN 5030-02669)	Seat Assembly	72099057	3283104M1
STANDARD SEAT			
9130, 9150, 9170, 9190	Seat and Mounting Bracket	72162763	NA
	Backrest, Black Vinyl	72162761	30V3225283
	Cushion, Black Vinyl	72162793	30V3343030
	Armrest, L	72161821	72161821
	Armrest, R	72161822	72161822
	Standard Seat Shock Absorber	72162151	72162151V
AIR-RIDE SEAT COMPONENTS			
9130, 9150, 9170, 9190	Seat Headrest	72162446	72162446V
	Seat Backrest	72162445	72162445V
	Seat Cushion	72162429	72162429V
	Armrests, L and R	72162447	72162447V
	Air Suspension, Spring	72162381	71365277V
	Air Suspension, Compression	72161870	72271386V

Knobs, Levers



70226023V



70234686V



70242338V



70243416V

Part No.	MUO	Description
KNOBS, LEVERS		
70242338V	B, IB, C	Knob, Hand Brake
70242338V	CA	Knob, Final Drive Clutch
70242338V	WC, WF, WD, WD45, WD45D	PTO & Belt Pulley Lever
70242338V	D10, D12	Hydraulic Levers
70242338V	D17	Knob, Snap Coupler Release Lever
70242338V	D21	Knob, PTO & Throttle Lever
70234686V	D10, D12 (Eff. SN D10-3501, D12-3001), D15 (Prior to SN 9001)	Knob, Choke Lever
70234686V	D17 (Prior to Series IV) (Eff. SN 32001 - 68500), D17 (Series IV), D19	Knob, Pump Control
70226023V	180, 185 (Prior to SN 12800) w/o Clutch, 185 (Eff. SN 12800) w/o Clutch	PTO Lever
70234686V	180, 185 (Prior to SN 12800)	Knob, Belt Pulley Shifter
70243416V	190, 190XT (Eff. SN 14186)	PTO Shifter w/o Clutch, Power Director
70242338V	190, 190XT, 190XT III (Prior to SN 14186)	Knob, PTO w/o Clutch, Throttle Lever, Traction Booster Lever, Hydraulic & PTO Levers
70242338V	200	Throttle Lever, Traction Booster Lever, Hydraulic & PTO Levers
70243416V	200 (Prior to SN 4001)	PTO Shifter w/o Clutch, Power Director
70269630V	200 (Eff. SN 4001)	Knob, Power Director Lever
70243416V	210	Shift Control
70242338V	210	Throttle Lever, Traction Booster Lever, Hydraulic & PTO Levers
70243416V	220, 220 FWA	Shift Control, Front Wheel Assist
70242338V	220, 220 FWA	Throttle Lever, Traction Booster Lever, Hydraulic & PTO Levers
70234686V	190, 190XT, 190XT III, 200, 210, 220, 220 FWA	Knob, Brake Lever
70226023V	B (Eff. SN 120982), IB (Eff. SN 26006), C, CA (Eff. SN 18971), WD, WD45, WD45D (Eff. SN 12700), D10, D12, D14, D15, D17, D19, D21, 190, 190XT, 190XT III, 200 (Prior to SN 4001), 210, 220, 220 FWA	Gear Shift Knob
70242338V	5020, 5020 FWD, 5030	Hydraulic Lever
70242338V	6060, 6070, 6080	Hydraulic Sensitivity Controls, Quick Hitch
70242338V	6140	Hydraulic Lever
70269630V	7000 (Eff. SN 8001), 7000 (Prior to SN 8001)	Knob, PTO
70257153V	WD, WD45, WD45D, D17, D19, 170, 175, 180, 185, 200 (Eff. SN 4001), 7000 (Prior to SN 8001), 7030, 7040, 7050, 7060, 7080, 7580	Knob, Gear Shift Lever
70269630V	7010, 7020, 7030, 7040, 7045, 7050, 7060, 7580	Knob, Differential Lock, Power Shift Lever, PTO Lever
70226023V	7000 (Eff. SN 8001), 7010, 7020, 7045, 7060 (Eff. SN 6001), 7080 (Eff. SN 3001), 7580 (Eff. SN 1605)	Inner Door Knob
70242338V	170, 175, 185 (Eff. SN 12800), 7000 (Eff. SN 8001), 7000 (Prior to SN 8001), 7010, 7020, 7030, 7040, 7045, 7050, 7060, 7080, 7580, 8010, 8030, 8050, 8070, 4W220, 4W305	Knob, Pump Control

Gauges, Meters



70231378V
Includes Hardware



70228718V
Includes Hardware



70277451V
Includes Hardware



70254407V
Includes Hardware

Allis-Chalmers Brand Gauges are shown as shaded sections.

MUO	Fuel Part No.	Tach & Hour Meter Part No.	Oil Pressure Part No.	Ammeter Part No.	Water Temp. Part No.
GAUGES, METERS					
B	NA	NA	70207834V*	70275840V*	70213675V
IB	NA	NA	70207834V*	70275840V*	70213675V (Eff. SN 3238)
C	NA	NA	70207834V*	70275840V*	70213675V
CA	NA	NA	70207834V*	70275840V*	70213675V
WC	NA	NA	70207834V*	70275840V*	70213675V**
WF	NA	NA	70207834V*	70275840V*	70213675V (Eff. SN 1904)
WD	NA	NA	70207834V* (Gas & LPG) 70228718V* (Diesel)	70275840V*	30V3485587
WD45	NA	NA	70207834V* (Gas & LPG) 70228718V* (Diesel)	70275840V*	30V3485587
D10	NA	NA	70228718V*	70254407V*	70229870V*
D12	NA	NA	70228718V*	70254407V*	70229870V*
D14	NA	NA	70228718V*	70254407V*	70229870V*
D15	NA	NA	70229632V*	70254407V*	70229870V*
D17	NA	NA	70229632V* (Diesel) 70228718V* (Gas)	70254407V*	70231378V*
D19	NA	NA	70229632V*	70254407V*	70231378V*
D21	70240988V*	NA	NA	70254407V*	70240989V*
170	70240988V*	NA	NA	70254407V*	70240989V*
175	70240988V*	NA	NA	70254407V*	70240989V*
180, 185 (Prior to SN 12800)	70240988V*	NA	NA	70254407V*	70240989V*
185 (Eff. SN 12800)	70240988V*	NA	NA	70254407V*	70240989V*
190	70240988V*	NA	NA	70254407V*	70240989V*
190XT	70240988V*	NA	NA	70254407V*	70240989V*
190XT III	70240988V*	NA	NA	70254407V*	70240989V*
200	NA	NA	NA	70254407V*	70240989V*
210	NA	NA	NA	70254407V*	70240989V*
220	NA	NA	NA	70254407V*	70240989V*
220 FWA	NA	NA	NA	70254407V*	70240989V*
7000	NA	70277451V*	NA	NA	NA
7010	NA	70277451V*	NA	NA	NA
7020	NA	70277451V*	NA	NA	NA
7030	NA	70277451V*	NA	NA	NA
7040	NA	70277451V*	NA	NA	NA
7050	NA	70277451V*	NA	NA	NA
7060	NA	70277451V*	NA	NA	NA

* Includes Hardware

** Eff. SN WC29845 (Square Radiator), Eff. SN 74330 (Styled). Power Unit: Eff. SN PU824W.

NA = Not Available

Gauge Components

AESTHETICS



Drive Assembly
70246764V



Adapter
70235724V



Shaft Assembly
70261605V

Part No.	Qty	MUO	Description
GAUGE COMPONENTS			
70246764V	1	D21, 170, 175, 180, 185, 190, 190XT, 190XT III, 200, 210, 220, 220 FWA	Drive Assembly, Tachometer
70235724V	1	D10, D12, D14, D15, D17, D19	Adapter, Temperature Gauge Tube To Cylinder Block
70257353V	1	180, 185, 190, 190XT, 190XT III, 200	Shaft Assembly, Flexible
70261605V	1	D15, D17, D19, D21, 190, 190XT, 190XT III	Shaft Assembly, Flexible 52-1/2" (Gas)
70256526V	1	D21, 170, 175, 190, 190XT, 190XT III, 210, 220, 220 FWA	Cable Assembly, Flexible
70261608V	1	D15, D17 Series IV, D19, D21, 190, 190XT, 190XT III	Key, Adapter

Body Panel Accessories



Handle
70243594V

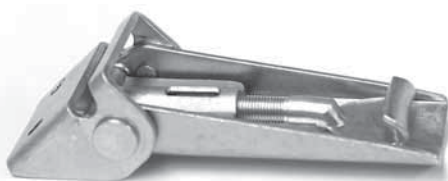

Latch
70243274V



Hook
70239911V



Bumper
70249403V

Part No.	MUO	Description
LATCHES, PANELS		
70239911V	160, 170, 175, 180, 185, 190, 190XT, 190XT III, 200, 210	Hook, Latch
70243274V	160, 170, 175, 180, 185, 190, 190XT, 190XT III, 200, 210	Latch
HANDLE		
70243594V	D21, 180, 185, 190, 190XT, 190XT III, 200, 210, 220, 220 FWA	Handle, Hand
BUMPER		
70249403V	170, 175, 180, 185, 190, 190XT, 190XT III, 200, 210	Bumper, Sheet Metal Panels

Liners, Pistons and Components



Liner
70208743V

Motor kits are shown as shaded sections.

Part No.	Qty	Description
B, C		
PISTONS		
70225653V	1	Piston Assembly, 6.2:1 Ratio (Eff. Eng. SN CE-153962, CR-47265 & Up)
LINERS		
70208743V	1	Liner (3-3/8")
70227501V	8	Packing, Cylinder Liner
RINGS		
70208740V	1	Ring, Piston, 2nd & 3rd Compression
70208741V	1	Ring, Piston, Scraper
70208742V	1	Ring, Piston, Oil
CONNECTING ROD BEARINGS		
70207460V	2	Bearing, Connecting Rod (STD, 2 Half)
70225672V	1	Connecting Rod Bolt
CYLINDER HEAD		
70228589V	1	Valve, Exhaust
70234829V	1	Valve, Intake
70234824V	1	Guide, Intake & Exhaust Valve
70226477V	4	Packing, Rocker Arm Cover
CRANKSHAFT		
70206961V	1	Bearing, Main Front Lower (STD, Half)
70211855V	1	Bearing, Main All Upper Center & Rear Lower (.0025" Half)



Motor Kit
70257454V

Part No.	Qty	Description
CA		
PISTONS		
70225653V	1	Piston Assembly, 6.2:1 Ratio (Eff. Eng. SN CE-153962)
LINERS		
70208743V	1	Liner
70227501V	8	Packing, Cylinder Liner
RINGS		
70208740V	1	Ring, Piston, 2nd & 3rd
COMPRESSION		
70208741V	1	Ring, Piston, Scraper
70208742V	1	Ring, Piston, Oil
CONNECTING ROD BEARINGS		
70207460V	2	Bearing, Connecting Rod (STD, 2 Half)
70225672V	1	Connecting Rod Bolt
CYLINDER HEAD		
70228589V	1	Valve, Exhaust
70234829V	1	Valve, Intake
70234824V	1	Guide, Intake & Exhaust Valve
70226477V	4	Packing, Rocker Arm Cover
CRANKSHAFT		
70206961V	1	Bearing, Main Front Lower (STD, Half)
70211855V	1	Bearing, Main All Upper Center & Rear Lower (.0025" Half)
WD, WD45 (EFF. ENG. SN 283022)		
PISTONS		
70229718V	1	Piston Assembly, 7.25:1, Gas & LPG
LINERS		
70257450V	1	Liner, Cylinder
RINGS		
70227500V	8	Ring, Packing
CYLINDER LINER		
70230086V	1	Ring, Compression Top (Chrome Face)
70229537V	1	Ring, Compression
PISTONS		
70229538V	1	Ring, Piston, Oil
MOTOR KIT		
70257454V		(Eff. Eng. SN 283022) 5.7:1 Ratio, Gas & LPG
Description		Part No.
Piston		70224917V
Rings, Oil		70229538V
Rings, Compression		70229537V
Rings, Top Compression		70230086V
Liners		70257450V
O-Ring, Liner Packing		70227500V
Instruction Sheet		

For complete overhaul kits, see pages 95-99

Liners, Pistons and Components

Part No.	Qty	MUO	Description
----------	-----	-----	-------------

WD, WD45 (EFF. ENG. SN 283022) CONTINUED

CONNECTING ROD BEARINGS

74517331V	2	WD45 Diesel	Bearing, Connecting Rod (STD)
70231122V	2	WD, WD45 Gas & LPG	Bearing, Connecting Rod (STD)
74517333V	2	WD45	Bearing, Connecting Rod (.10")
74517334V	2	WD45 Diesel	Bearing, Connecting Rod (.020")
74517335V	2	WD45 Diesel	Bearing, Connecting Rod (.040")
70204926V	1	WD, WD45 Gas & LPG	Bearing, Connecting Rod (.020" Undersize)
70213356V	1	WD, WD45 Gas & LPG	Bearing, Connecting Rod (.40" Undersize)
70209339V	1	WD, WD45 Gas & LPG	Bearing, Connecting Rod (.005" Undersize)

CYLINDER HEAD VALVES

70241527V	1	WD Gas (Prior to SN 289000)	Valve, Exhaust
70209132V	1	WD Gas (Prior to SN 289000)	Valve, Intake
70229911V	1	WD (Prior to SN 289000), WD, WD45 Gas & LPG (Eff. SN 289000 & Up)	Guide, Exhaust Valve
70241536V	1	WD (Prior to SN 289000), WD, WD45 Gas & LPG (Eff. SN 289000)	Guide, Intake Valve
70209103V	1	WD Gas (Prior to SN 289000)	Lock, Valve Spring Retainer, Half
70226477V	4	WD, WD45	Packing, Cover Stud
70225672V	1	WD45 Diesel	Nut, Valve Lash Adjustment Screw

ENGINE GASKETS

70277290V	1	WD, WD45	Gasket Set, Complete
-----------	---	----------	----------------------

OVERHAUL

70277286V	1	WD, WD45	Gasket Set, Cylinder
-----------	---	----------	----------------------

HEAD OVERHAUL

70277304V	1	WD (Prior to SN 289000), WD & WD45 Gas & LPG (Eff. SN 289000)	Gasket, Cylinder Head
70255297V	1	WD, WD45	Gasket, Rocker Arm Cover
70203036V	1	WD, WD45 Gas & LPG (Eff. SN 289000)	Gasket, Rear Bearing Cap

WD, WD45

SEALS

74502930V	1	WD45 Diesel	Oil Seal, Rear Outer
70227120V	1	WD, WD45 Gas & LPG	Oil Seal, Rear Half

Part No.	Qty	MUO	Description
----------	-----	-----	-------------

74513621V	1	WD45 Diesel	Seal, Oil (Timing Gear Cover)
-----------	---	-------------	----------------------------------

70275814V	1	WD, WD45 (Eff. Eng. SN 45-6650)	Front Oil Seal, Cover
-----------	---	------------------------------------	-----------------------

CRANKSHAFT MAIN BEARINGS

70254760V	1	WD, WD45 Gas & LPG	Bearing, Center & Rear (STD, Half)
-----------	---	--------------------	------------------------------------

70228604V	1	WD, WD45 Gas & LPG	Bearing, Front, (STD, Half)
-----------	---	--------------------	--------------------------------

70229912V	1	WD, WD45 Gas & LPG	Bearing, Center & Rear (.0025" Undersize, Half)
-----------	---	--------------------	--

70229913V	1	WD, WD45 Gas & LPG	Bearing, Front (.0025" Undersize, Half)
-----------	---	--------------------	--

70213354V	1	WD, WD45 Gas & LPG	Bearing, Front (.040" Undersize, Half)
-----------	---	--------------------	---

70213355V	1	WD, WD45 Gas & LPG	Bearing, Center & Rear (.040" Undersize, Half)
-----------	---	--------------------	---

74514848V	2	WD45 Diesel	Bearing, Main, Front (STD)
-----------	---	-------------	-------------------------------

74514849V	1	WD45 Diesel	Bearing, Main, Front (.010")
-----------	---	-------------	---------------------------------

74514858V	2	WD45 Diesel	Bearing, Main, Rear (STD)
-----------	---	-------------	------------------------------

74514859V	2	WD45 Diesel	Bearing, Main, Rear (.010")
-----------	---	-------------	--------------------------------

74514843V	2	WD45 Diesel	Bearing, Main, Center (STD)
-----------	---	-------------	--------------------------------

74514844V	2	WD45 Diesel	Bearing, Main, Center (.010")
-----------	---	-------------	----------------------------------

74514853V	2	WD45 Diesel	Bearing, Main, Intermediate (STD)
-----------	---	-------------	--------------------------------------

74514854V	2	WD45 Diesel	Bearing, Main, Intermediate (.010")
-----------	---	-------------	--

WC, WF

PISTONS & RINGS

70229718V	1	Piston Assembly, 5.02:1 Ratio, Gas
-----------	---	------------------------------------

LINERS

70257450V	1	Liner, Cylinder (Liner 3/32" grooves) (Eff. Eng. SN 65528)
-----------	---	---

RINGS

70227500V	8	Ring, Packing, Cylinder Liner (Use Liner with 3/32" grooves) (Eff. Eng. SN 65528)
-----------	---	---

70230086V	1	Ring, Compression Top (Chrome Face)
-----------	---	--

70229537V	1	Ring, Compression, Piston
-----------	---	---------------------------

70229538V	1	Ring, Piston, Oil
-----------	---	-------------------

Liners, Pistons and Components

MOTOR KIT	
70257454V	5.7:1 Ratio, Gas
Description	Part No.
Piston	70224917V
Rings, Oil	70229538V
Rings, Compression	70229537V
Rings, Top Compression	70230086V
Liners	70257450V
O-Ring, Liner Packing	70227500V
Instruction Sheet	

Part No.	Qty	Description
CONNECTING ROD BEARINGS		
70209339V	1	Bearing, Connecting Rod (.050" Undersize) (Eff. Eng. W-13665)
70213356V	1	Bearing, Connecting Rod (.040" Undersize) (Eff. Eng. W-13665)
70204926V	1	Bearing, Connecting Rod (.020" Undersize) (Eff. Eng. W-13665)
70231122V	2	Bearing, Connecting Rod (STD Undersize) (Eff. Eng. W-13665)

CYLINDER HEAD VALVES		
70241527V	1	Valve, Exhaust
70209132V	1	Valve, Intake
70229911V	1	Guide, Exhaust Valve
70241536V	1	Guide, Intake Valve
70209103V	1	Lock, Valve Spring Retainer, Half
70226477V	4	Packing, Cover Stud
70225672V	1	Nut, Valve Lash Adjustment Screw

ENGINE GASKETS		
70277290V	1	Gasket Set, Complete Overhaul
70277304V	1	Gasket
70277286V	1	Gasket Set
70255297V	1	Gasket, Rocker Arm Cover
70203036V	1	Gasket, Rear Bearing Cap

SEALS		
70227120V	1	Seal, Oil Rear Half

CRANKSHAFT MAIN BEARINGS		
70203869V	1	Main Bearing Center & Rear (Half)
70254760V	1	Main Bearing, Center & Rear (STD Half)
70213354V	1	Main Bearing, Front (.040" Undersize, Half)
70229913V	1	Main Bearing, Front (.0025" Undersize, Half)
70228604V	1	Main Bearing, Front (STD Half)
70213355V	1	Main Bearing, Center & Rear (.040" Undersize)
70229912V	1	Main Bearing, Center & Rear (.0025" Undersize)

Part No.	Qty	Description
----------	-----	-------------

D10, D12

LINERS		
70226477V	4	Packing, Cover Stud

RINGS		
70208740V	1	Ring, Piston, 2nd & 3rd Compression (Prior to Tractor SN D10 3501 & D12 3001)

CONNECTING ROD BEARINGS

70237815V	1	Bearing, Connecting Rod, (.0025" Undersize, 2 Half)
70237653V	2	Bearing, Connecting Rod (STD, 2 Half)
70225672V	1	Connecting Rod Bolt

MOTOR KIT	
70284393V	7.5:1 Ratio, Gas

Description	Part No.
Piston Assembly	70229739V
Liner	70227562V
Ring, Packing, Cylinder Liner	70227563V
Ring, Top Compression Ring (Chrome Face)	70230197V
Ring, Compression, 2nd & 3rd	70227564V
Ring, Oil, Segment Type (Chrome Face)	70230200V

CYLINDER HEAD

70234829V	1	Valve, Intake
70228589V	1	Valve, Exhaust
70234824V	1	Guide, Intake & Exhaust Valve

ENGINE GASKETS

70277276V	1	Gasket, Cylinder Head
70277264V	1	Gasket Set, Cylinder Head Overhaul
70255296V	1	Gasket, Rocker Arm Cover

SEALS

70275814V	1	Front Oil Seal, Cover
-----------	---	-----------------------

CRANKSHAFT

70237827V	1	Bearing, Rear Main, (.001" Undersize, 2 Half)
70237829V	1	Bearing, Rear Main, (.0025" Undersize, 2 Half)
70237652V	2	Bearing, Rear Main (STD)
70237823V	1	Bearing, Front & Center Main (.001" Undersize, 2 Half)
70237651V	2	Bearing, Front & Center Main (STD, 2 Half)

D14

LINERS		
70227500V	8	Ring, Packing, Cylinder Liner

CONNECTING ROD BEARINGS

70237815V	1	Bearing, Connecting Rod (2 Half)
70237653V	2	Bearing, Connecting Rod (STD 1 Half)
70225672V	1	Connecting Rod Bolt

Liners, Pistons and Components

D14 CONTINUED

MOTOR KIT

70284393V 7.5:1 Ratio, Gas & LPG

Description	Part No.
Piston Assembly	70229739V
Liner	70227562V
Ring, Packing, Cylinder Liner	70227563V
Ring, Top Compression Ring (Chrome Face)	70230197V
Ring, Compression, 2nd & 3rd	70227564V
Ring, Oil, Segment Type (Chrome Face)	70230200V

Part No. Qty Description

CYLINDER HEAD VALVES

70234829V	1	Valve, Intake
70228589V	1	Valve, Exhaust
70234824V	1	Guide, Intake & Exhaust Valve
70226477V	4	Packing, Rocker Arm Cover

ENGINE GASKETS

70277264V	1	Gasket Set, Cylinder Head Overhaul
70277276V	1	Gasket, Cylinder Head
70255296V	1	Gasket, Rocker Arm Cover

SEALS

70275814V	1	Front Oil Seal, Cover
-----------	---	-----------------------

CRANKSHAFT MAIN BEARINGS

70237829V	1	Bearing, Rear Main (.025" Undersize, 2 Half), (Eff. Tractor SN 19001) (Eff. Eng. SN 19070)
70237827V	1	Bearing, Rear Main, (.001 Undersize, 2 Half)
70237652V	2	Bearing, Main, Rear (STD)
70237651V	2	Bearing, Front & Center Main, 2 (STD Half) (Eff. Tractor SN 19001) (Eff. Eng. SN 19070)
70237823V	1	Bearing, Front & Center Main, (.001" Undersize, 2 Half), (Eff. Tractor SN 19001) (Eff. Eng. SN 19070)

D15

PISTONS

74061559V	1	Piston Kit (For Single Cylinder Diesel)
-----------	---	---

LINERS

74061520V	1	Liner
74008103V	1	Liner Kit (Eff. Eng. SN D-06370)
70227500V	8	Ring, Packing, Cylinder Liner

CONNECTING ROD BEARINGS

70237815V	1	Bearing, Connecting Rod, (.025" Undersize, 2 Half) Gas & LPG
70237653V	2	Bearing, Connecting Rod, (STD, Half) Gas & LPG
74517335V	2	Bearing, Connecting Rod (.040") Diesel
74517334V	2	Bearing, Connecting Rod (.020") Diesel
74517332V	1	Bearing, Connecting Rod (.002") Diesel
74517331V	2	Bearing, Connecting Rod (STD) Diesel
74517333V	2	Bearing, Connecting Rod (.10") Diesel
70225672V	1	Connecting Rod Bolt

MOTOR KIT

70284393V 7.5:1 Ratio, Gas & LPG

Description	Part No.
Piston Assembly	70229739V
Liner	70227562V
Ring, Packing, Cylinder Liner	70227563V
Ring, Top Compression Ring (Chrome Face)	70230197V
Ring, Compression, 2nd & 3rd	70227564V
Ring, Oil, Segment Type (Chrome Face)	70230200V

Part No. Qty Description

CYLINDER HEAD VALVES

70234829V	1	Valve, Intake
70228589V	1	Valve, Exhaust
70234824V	1	Guide, Intake & Exhaust Valve
70226477V	4	Packing, Cover

ENGINE GASKETS

70277263V	1	Gasket Set, Complete Engine Overhaul
70277276V	1	Gasket, Cylinder Head (Prior to Tractor SN 9001)
70255296V	1	Gasket, Rocker Arm Cover

SEALS

74513621V	1	Front Oil Seal, Timing Gear Cover
74516486V	1	Rear Oil Seal
74502930V	1	Outer Oil Seal, Flywheel
70275814V	1	Front Oil Seal, Cover

CRANK SHAFT

70237827V	1	Bearing, Rear Main (2 Half)
70237829V	1	Bearing, Rear Main (2 Half)
70237652V	2	Bearing, Main, Rear (STD)
74514858V	2	Bearing, Main, Rear (STD)
74514859V	2	Bearing, Main, Rear (.010")
74514853V	2	Bearing, Main, Intermediate (STD)
74514854V	2	Bearing, Main, Intermediate (.010")
74514848V	2	Bearing, Main, Front (STD)
74514849V	1	Bearing, Main, Front (.010")
74514843V	2	Bearing, Main, Center (STD)
74514844V	2	Bearing, Main, Center (.010")
70237651V	2	Bearing, Front & Center Main (STD, 2 Half)
70237823V	1	Bearing, Front & Center Main (.001", 2 Half)
74514848V	2	Bearing, Main, Front (STD)
74514849V	1	Bearing, Main, Front (.010")
74514843V	2	Bearing, Main, Center (STD)
74514844V	2	Bearing, Main, Center (.010")
70237651V	2	Bearing, Front & Center Main (STD, 2 Half)
70237823V	1	Bearing, Front & Center Main (.001", 2 Half)

D17 (PRIOR TO SERIES IV)

PISTONS

70229718V	1	Piston Assembly
70230577V	1	Piston Assembly, 8.25:1 Ratio
74061559V	1	Piston & Sleeve Kit

Liners, Pistons and Components

Part No.	Qty	Description
SLEEVES		
74061520V	1	Sleeve, Cylinder
70257450V	1	Liner, Cylinder
RINGS		
70229538V	1	Ring, Piston, Oil
70227500V	8	Ring, Packing, Cylinder Liner
70229537V	1	Ring, Compression, Piston
70230086V	1	Ring, Compression Top (Chrome Face)
CONNECTING ROD BEARINGS		
74517335V	2	Bearing, Connecting Rod (.040")
74517334V	2	Bearing, Connecting Rod (.020")
74517332V	1	Bearing, Connecting Rod (.002")
70231122V	2	Bearing, Connecting Rod
74517331V	2	Bearing, Rod
74517333V	2	Bearing, Rod
70225672V	1	Connecting Rod Bolt
CYLINDER HEAD VALVES		
70241527V	1	Valve, Exhaust
70241536V	1	Guide, Intake Valve
70229911V	1	Guide, Exhaust Valve
70209103V	1	Lock, Valve Spring Retainer, Half
70226477V	4	Packing, Stud (Prior to Eng. SN 405214)
CYLINDER HEAD SEALS		
74513621V	1	Front Oil Seal, Timing Gear Cover
74516486V	1	Rear Oil Seal
74502930V	1	Outer Oil Seal, Flywheel
ENGINE GASKETS		
70277161V	1	Gasket Set, Engine Overhaul Kit
70277290V	1	Gasket Set
70277286V	1	Gasket Set
70277304V	1	Gasket
70255297V	1	Gasket, Rocker Arm Cover
70226477V	4	Packing, Stud (Prior to Eng. SN 405214)
CRANKSHAFT MAIN BEARINGS		
74514859V	2	Bearing, Main, Rear (.010")
74514858V	2	Bearing, Main, Rear (STD)
74514854V	2	Bearing, Main, Intermediate (.010")
74514853V	2	Bearing, Main, Intermediate (STD)
74514849V	1	Bearing, Main, Front (.010")
74514848V	2	Bearing, Main, Front (STD)
74514844V	2	Bearing, Main, Center (.010")
74514843V	2	Bearing, Main, Center (STD)
70241104V	1	Bearing, Main, Center
70241103V	2	Bearing, Main, Front & Rear, Standard
D17		
PISTONS		
74061559V	1	Piston, Diesel
70229718V	1	Piston Assembly, Gas & LPG, 7.25:1 Ratio
70230577V	1	Piston Assembly, Gas & LPG, 8.25:1 Ratio

Part No.	Qty	Description
LINERS		
70257450V	1	Liner
74061520V	1	Liner Kit (Includes Packing Ring)
RINGS		
70230086V	1	Ring, Compression Top (Chrome Face)
70229537V	1	Ring, Compression, Piston
70227500V	8	Ring, Packing, Cylinder Liner
70229538V	1	Ring, Piston, Oil
CONNECTING ROD BEARINGS		
74517331V	2	Bearing, Connecting Rod (STD)
74517333V	2	Bearing, Connecting Rod (.10")
74517335V	2	Bearing, Connecting Rod (.040")
74517334V	2	Bearing, Connecting Rod (.020")
74517332V	1	Bearing, Connecting Rod (.002")
70231122V	2	Bearing, Connecting Rod (STD, Half)
70225672V	1	Connecting Rod Bolt
CYLINDER HEAD		
70241527V	1	Valve, Exhaust
70229911V	1	Guide, Exhaust Valve
70241536V	1	Guide, Intake Valve
70209103V	1	Lock, Valve Spring Retainer (Half)
70226477V	4	Packing, Cover
ENGINE GASKETS		
70277161V	1	Gasket Set, Engine Overhaul Kit, Diesel
70277286V	1	Gasket Set, Cylinder Head
70277290V	1	Gasket Set, Engine Overhaul Kit, Gas
70255297V	1	Gasket, Rocker Arm Cover
SEALS		
74513621V	1	Front Oil Seal, Timing Gear Cover
74516486V	1	Rear Oil Seal
74502930V	1	Outer Oil Seal, Flywheel
CRANKSHAFT		
74514858V	2	Bearing, Main, Rear (STD)
74514859V	2	Bearing, Main, Rear (.010")
74514853V	2	Bearing, Main, Intermediate (STD)
74514854V	2	Bearing, Main, Intermediate (.010")
74514848V	2	Bearing, Main, Front (STD)
74514849V	1	Bearing, Main, Front (.010")
70241103V	2	Bearing, Main, Front & Rear (STD)
74514843V	2	Bearing, Main, Center (STD)
74514844V	2	Bearing, Main, Center (.010")
70241104V	1	Bearing, Main, Center
D19		
PISTONS		
74061554V	1	Piston, Gasoline
LINERS		
74061520V	1	Liners
70227500V	8	Ring, Packing, Liner
CONNECTING ROD BEARINGS		
74517335V	2	Bearing, Connecting Rod (.040")
74517334V	2	Bearing, Connecting Rod (.020")
74517332V	1	Bearing, Connecting Rod (.002")
74517331V	2	Bearing, Connecting Rod (STD)
74517333V	2	Bearing, Connecting Rod (.10")

Liners, Pistons and Components

Part No.	Qty	Description
----------	-----	-------------

D19 CONTINUED

CONNECTING ROD BEARINGS CONTINUED

70225672V	1	Connecting Rod Bolt
-----------	---	---------------------

CYLINDER HEAD MAIN BEARINGS

74514858V	2	Bearing, Main, Rear (STD)
74514859V	2	Bearing, Main, Rear (.010")
74514853V	2	Bearing, Main, Intermediate (STD)
74514854V	2	Bearing, Main, Intermediate (.010")
74514848V	2	Bearing, Main, Front (STD)
74514849V	1	Bearing, Main, Front (.010")
74514843V	2	Bearing, Main, Center (STD)
74514844V	2	Bearing, Main, Center (.010")
7451 3832V	10	Packing, Stud (Prior to Eng. SN 405214)
70226477V	4	Packing, Stud (Prior to Eng. SN 405214)

FLYWHEEL

74008103V	1	Wear Sleeve
-----------	---	-------------

SEALS

74513621V	1	Front Oil Seal, Timing Gear Cover
74516486V	1	Rear Oil Seal (Prior to Diesel SN D-04957 & all Gas & LPG)
74502930V	1	Outer Oil Seal, Flywheel

ENGINE GASKETS

74517316V	1	Gasket, Cylinder Head
74516181V	1	Gasket Kit
70277027V	1	Gasket

D21

PISTONS & RINGS

74036680V	1	Piston Kit
74062401V	1	Ring Set

LINERS

74037221V	1	Liner Kit
-----------	---	-----------

CONNECTING ROD BEARINGS

74036261V	2	Bearing, Connecting Rod (STD)
74036426V	1	Bearing, Connecting Rod (.010")
74036427V	1	Bearing, Connecting Rod (.020")
74062337V	1	Bearing Kit, Connecting Rod (STD)
74036429V	1	Bearing Kit, Connecting Rod (.040")
74062516V	1	Bearing Kit, Connecting Rod (.020")
74062515V	1	Bearing Kit, Connecting Rod (.010")
74025031V	6	Connecting Rod Bushing

CYLINDER HEAD BOLTS

74035389V	1	Capscrew, Cylinder Head (long)
74035388V	1	Capscrew, Cylinder Head (short)

CYLINDER HEAD VALVES

74036609V	2	Exhaust Valve
74037135V	2	Valve Intake
74022595V	2	Guide, Intake and Exhaust
74035186V	6	Valve Spring
74026699V	1	Valve, Lifter
74028110V	2	Rod, Push

Part No.	Qty	Description
----------	-----	-------------

ROCKER ARM ASSEMBLY

74025188V	4	Arm Assembly, Rocker
70277421V	1	Arm Assembly, Rocker

MISC. COMPONENTS

70935121V	1	O-Ring, Oil Tube
-----------	---	------------------

ENGINE GASKETS

74037120V	1	Gasket Set, Complete Overhaul
70277040V	1	Gasket Set, Cylinder Head
70277414V	1	Gasket Set, Cylinder Head
74035214V	1	Gasket, Cylinder Head

CRANKSHAFT MAIN BEARINGS

74035009V	1	Rear & Center, Upper (STD)
74035048V	1	Rear & Center, Upper (.020")
74035047V	2	Rear & Center, Upper (.010")
74035010V	1	Rear & Center, Lower (STD)
74035053V	1	Rear & Center, Lower (.020")
74035052V	1	Rear & Center, Lower (.010")
74035007V	1	Front & Intermediate, Upper (STD)
74035038V	1	Front & Intermediate, Upper (.020")
74035037V	1	Front & Intermediate, Upper (.010")
74035008V	1	Front & Intermediate, Lower
74035042V	1	Front & Intermediate, Lower
74035043V	1	Front & Intermediate, Lower
74061642V	1	Main Bearing Set (STD)
74061650V	1	Main Bearing Set (-0.02")
74061649V	1	Main Bearing Set (-0.01")

SEALS

74036340V	1	Seal Kit, Oil, Crankshaft
74062088V	1	Rear Oil Seal, Flywheel

FLYWHEEL

74029556V	1	Wear Sleeve
-----------	---	-------------

TIMING

74029000V	1	Camshaft
74021454V	1	Plate, Thrust (Eff. SN 3D-03627)

160

PISTONS

743824V91	1	Piston Assembly
-----------	---	-----------------

LINERS

739043V1	1	Liner
----------	---	-------

RINGS

836325V91	1	Piston Ring Set
731988V1	1	Ring, Starter

CONNECTING RODS

737070V91	1	Bearing, Connecting Rod (STD)
737072V91	1	Bearing, Connecting Rod (.020")

CONNECTING ROD KIT

3637392V91	1	Kit, Connecting Rod (Includes Bushing, Bolt & Nut)
740407V1	1	Connecting Rod Bushing
731192V1	1	Tab Washer
375756V1	1	Connecting Rod Bolt

CYLINDER HEAD ASSEMBLY

4222810V91		Cylinder Head Assembly
------------	--	------------------------

Liners, Pistons and Components

Part No.	Qty	Description
VALVES		
737640V1	1	Valve, Exhaust
732811V1	1	Valve, Intake
732445V1	1	Guide, Valve
731155V1	10	Lock, Valve
731154V1	1	Spring, Valve, Outer
731150V1	1	Tappet, Valve
ENGINE GASKETS		
735057V1	1	Gasket, Cylinder Head
4222050V1	10	Gasket, Exhaust Manifold (Manifold to Head)
4222475M1	1	Gasket, Exhaust Manifold (Manifold to Head) (Eff. Tractor SN 01430676)
3641399V91	1	Gasket, Head
4223567V1	1	Gasket, Timing Cover
SEALS		
72080025V	1	Seal, Oil (Tach Housing)
735866V1	2	Seal, Oil, Rear
636762V1	1	Seal, Oil (Tach Housing)

Part No.	Qty	Description
TIMING		
733507V1	1	Camshaft
ENGINE BLOCK		
731356V1	1	Plug (11/16"), Pressure Rail
731354V1	1	Plug, Water Jacket (Front)
70912415V	1	Drain Cock (Water)
CRANKSHAFT MAIN BEARINGS		
746156V91	1	Bearing, Main (STD)
THRUST WASHERS		
735113V1	1	Washer, Thrust, Rear Main Bearing
735112V1	1	Washer, Thrust, Rear Main Bearing
735801V1	1	Washer, Thrust, Rear Main Bearing, Bottom
735800V1	1	Washer, Thrust, Rear Main Bearing, Top
GEARS		
3641826V1	1	Crankshaft Gear
CAMSHAFT GEARS		
3637541V1	1	Camshaft Gear (50 Splines)

Part No.	Qty	MUO	Description
170, 175			
PISTONS			
70230577V	1	175 Gas	Piston Assembly, 8.25:1 Ratio
735187V91	1	170, 175 w/ 4.236 Engine Diesel	Piston Assembly (STD)
740821V91	1	175 w/ 4.248 Engine Diesel	Piston Assembly (STD)
747041V91	1	175 w/ 4.248 Engine Diesel	Piston Assembly (STD)
LINERS			
70257450V	1	170, 175 Gas	Liner
70227500V	8	170, 175 Gas	Packing, Cylinder Liner
737214V1	1	175 w/ 4.248 Engine Diesel	Liner
734644V1	1	170, 175 w/ 4.236 Engine Diesel	Liner
RINGS			
70230086V	1	170, 175 Gas	Ring, Compression Top (Chrome Face)
70229537V	1	170, 175 Gas	Ring, Compression
70229538V	1	170, 175 Gas	Ring, Piston, Oil (Segment Type)
CONNECTING ROD BEARINGS			
70231122V	2	170 Gas	Bearing, Connecting Rod (STD)
736951V91	1	170, 175 Diesel	Bearing Set, Connecting Rod (.010")
736950V91	1	170, 175 Diesel	Bearing Set, Connecting Rod (STD)
733767V1	1	170, 175 Diesel	Connecting Rod Bearing Set
CONNECTING ROD ASSEMBLIES			
3637034V91	1	170, 175 Diesel	Connecting Rod Assembly
CYLINDER HEAD VALVES			
70241527V	1	170, 175 Gas	Valve, Exhaust
70229911V	1	170, 175 Gas	Guide, Exhaust Valve
70241536V	1	170, 175 Gas	Guide, Intake Valve
70209103V	1	170, 175 Gas	Lock, Valve Spring Retainer (Half)
70226477V	4	170, 175 Gas	Packing, Valve Cover
747552V1	2	170, 175 Diesel	Valve, Exhaust (STD)
735525V1	1	170, 175 w/4.248 Engine Diesel	Spring, Valve, Inner
739027V1	1	170, 175 Diesel	Valve, Intake (STD)
736812V1	1	170, 175 Diesel	Valve, Intake (.003")



74517331V



70234829V

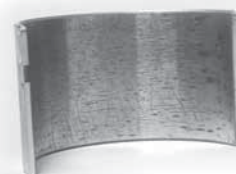

70204926V

Liners, Pistons and Components



731154V1

ENGINE



732811V1



70228589V



70229538V

Part No.	Qty	MUO	Description
170, 175 CONTINUED			
CYLINDER HEAD VALVES CONTINUED			
70251232V	1	170, 175 Diesel	Cotter, Valve Spring
735521V1	1	170, 175 Diesel	Spring, Valve, Outer
4222069V1	1	170, 175 Diesel	Tappet
1447690V1	1	170, 175 Diesel	Seal, Valve
3637030V1	1	170, 175 Diesel	Cylinder Head, Nut
ENGINE GASKETS			
70277304V	1	170, 175 Gas	Gasket, Cylinder Head
70277286V	1	170, 175 Gas	Gasket Set, Cylinder Head
70277290V	1	170, 175 Gas	Gasket Set, Complete Engine Overhaul
70255297V	1	170, 175 Gas	Gasket, Rocker Arm Cover
3638983V91	1	170 Diesel	Gasket Set, Top Overhaul
4224189V91	1	170 Diesel	Gasket Set, Top Overhaul
3641224V1	1	170, 175 Diesel	Gasket (Timing Cover Gasket) (Eff. SN 24801785L)
3638845V1	1	170, 175 Diesel	Gasket, Cylinder Head
SEALS			
1447691V1	1	170, 175 Diesel	Rear Oil Seal (Lip Type) (Eff. SN 248U17857L)
3637041V1	1	175 Diesel	Seal
735942V1	2	170, 175 Diesel	Seal, Housing (Prior to SN 248U17857L)
CRANKSHAFT MAIN BEARINGS			
70241104V	1	170, 175 Gas	Bearing, Main, Center (STD)
70241103V	2	170, 175 Gas	Bearing, Main, Front & Rear (STD)
735168V91	1	170, 175 Diesel	Bearing, Main Front, Rear & Center (STD)
CRANKSHAFT KIT			
3639541V1	1	170, 175 Diesel	Crankshaft Kit (.010" Undersize, Bearings)
CRANKSHAFT COMPONENTS			
734749V1	1	170, 175 Diesel	Gear, Crankshaft
747129V1	1	170, 175 Diesel	Bottom Thrust Washer (STD)
TIMING			
736818V1	1	175 w/ 4.248 Engine Diesel	
CAMSHAFT			
3637075V91	1	170, 175 Diesel	Gear Assembly, Camshaft (w/ Bushing)
ENGINE BLOCK			
735944V1	1	170, 175 Diesel	Plug (1-3/8")
731354V1	1	170, 175 Diesel	Plug, Water Jacket (Front)
180, 185 (PRIOR TO SN 12800)			
PISTON			
74062355V	1	180, 185 Diesel	Piston Kit
LINERS			
74061938V	1	180, 185 Diesel	Liner Kit
RINGS			
74062157V	1	180, 185 Diesel	Ring Set (Includes 3 Rings, Expander)

Liners, Pistons and Components

Part No.	Qty	MUO	Description
CONNECTING ROD BEARINGS			
74007740V	4	180, 185	Bearing, Connecting Rod (.010")
74007741V	4	180, 185	Bearing Kit, Connecting Rod (.020")
74008168V	1	180, 185	Bearing Kit, Connecting Rod (.030")
74007700V	4	180, 185	Bearing, Connecting Rod (STD) (Eff. SN 2D-11864)
74020049V	1	180, 185	Connecting Rod Bushing
CYLINDER HEAD BOLTS			
74035389V	1	180, 185 Diesel	Capscrew, Cylinder Head (long)
74035388V	1	180, 185 Gas	Capscrew, Cylinder Head (short)
VALVES			
74009936V	1	180, 185	Valve, Exhaust (Eff. SN 2D-90967)
74023378V	2	180, 185	Valve, Intake
74035186V	6	180, 185	Valve Spring
74026699V	1	180, 185	Valve, Lifter
74022595V	2	180, 185	Guide, Intake and Exhaust
74021454V	1	180, 185	Plate, Thrust
74020185V	1	180, 185	Rod, Push
74025188V	4	180, 185 Diesel	Arm Assembly, Rocker
70277421V	1	180, 185 Diesel	Arm Assembly, Rocker
ENGINE GASKETS			
74009450V	1	180, 185 Diesel	Gasket Set, Cylinder Head
70277058V	1	180 Gas	Gasket Set, Cylinder Head
70277089V	1	180, 185 Diesel	Gasket Set, Complete Overhaul
70277087V	1	180, 185 Diesel	Gasket Set, Intermediate
74008795V	1	180, 185	Gasket, Cover End
74023471V	1	180, 185 Diesel	Gasket, Cylinder Head
74020184V	1	180, 185 Gas	Gasket, Cylinder Head Cover
74008074V	1	180, 185 Diesel	Gasket, Cylinder Head Cover
70277088V	1	180 Gas	Gasket Set, Complete Overhaul
SEALS			
74008103V	1	180, 185 (Prior to SN 12800)	Oil Seal, Sleeve (Flywheel Adapter Plate)
74024561V	1	180, 185 (Prior to SN 12800)	Front Oil Seal (Eff. Eng. SN 74008155)
74024562V	1	180, 185 (Prior to SN 12800)	Rear Oil Seal
CRANKSHAFT			
74006059V	1	180, 185	Bearing Kit, Main (STD)
74006061V	1	180, 185	Bearing Kit, Main (.010")
74006063V	1	180, 185	Bearing Kit, Main (.020")
70277394V	1	180, 185	Bearing, Center & Upper (.010") (Eff. Eng. SN 11864)
74006160V		180, 185	Bearing, Center, Lower (STD) (Eff. Eng. SN 11864)
74006162V	1	180, 185	Bearing, Center, Lower (.010") (Eff. Eng. SN 11864)
74006164V	1	180, 185	Bearing, Center, Lower (.020") (Eff. Eng. SN 11864)
70277392V	1	180, 185	Bearing, Center, Upper (.020") (Eff. Eng. SN 11864)
70277393V	1	180, 185	Bearing, Front & Intermediate, Upper (.010") (Eff. Eng. SN 11864)



70209132V



70213356V



737070V91

Liners, Pistons and Components

ENGINE



734849V1

Part No.	Qty	MUO	Description
180, 185 (PRIOR TO SN 12800) CONTINUED			
CRANKSHAFT CONTINUED			
70277391V	1	180, 185	Bearing, Front & Intermediate, Upper (.020") (Eff. Eng. SN 11864)
74007759V	1	180, 185	Bearing, Front and Intermediate, Lower (.010") (Eff. Eng. SN 11864)
74007760V	1	180, 185	Bearing, Front and Intermediate, Lower (.020") (Eff. Eng. SN 11864)
74007695V	1	180, 185	Bearing, Front and Intermediate, Lower (STD) (Eff. Eng. SN 11864)
74007753V	1	180, 185	Bearing, Rear, Lower (.010") (Eff. Eng. SN 11864)
74007754V	1	180, 185	Bearing, Rear, Lower (.020") (Eff. Eng. SN 11864)
74007697V	1	180, 185	Bearing, Rear, Lower (STD) (Eff. Eng. SN 11864)
74007743V	1	180, 185	Bearing, Rear, Upper (.010") (Eff. Eng. SN 11864)
74007744V	1	180, 185	Bearing, Rear, Upper (.020") (Eff. Eng. SN 11864)
74007696V	1	180, 185	Bearing, Rear, Upper (STD) (Eff. Eng. SN 11864)
185 (EFF. SN 12800)			
PISTON			
74062355V	1	185 Diesel	Piston Kit
LINERS			
74061938V	1	185	Liner Kit
RINGS			
74062157V	1	185	Ring Set (Includes 3 Rings, Expander)
CONNECTING ROD BEARINGS			
74007700V	4	185	Bearing, Connecting Rod (STD) (Eff. Eng. SN 2D-11864)
74007740V	4	185	Bearing, Connecting Rod (.010")
74007741V	4	185	Bearing Kit, Connecting Rod (.020")
74008168V	1	185	Bearing Kit, Connecting Rod (.030")
74020049V	1	185	Connecting Rod Bushing
CYLINDER HEAD BOLTS			
74035389V	1	185	Capscrew, Cylinder Head (long)
74035388V	1	185	Capscrew, Cylinder Head (short)
VALVES			
74009936V	1	185	Valve, Exhaust (Eff. Eng. SN 2D-90967)
74023378V	2	185	Valve, Intake
74022595V	2	185	Guide, Intake and Exhaust
74035186V	6	185	Valve Spring
74026699V	1	185	Valve, Lifter
ROCKER ARMS			
74025188V	4	185	Rocker Arm Assembly
70277421V	1	185	Rocker Arm Assembly
74020185V	1	185	Rod, Push



70229537V



70256031V

Liners, Pistons and Components

Part No.	QTY	MUO	Description
ROCKER ARMS CONTINUED			
74021454V	1	185	Plate, Thrust
ENGINE GASKETS			
74009450V	1	185	Gasket Set, Cylinder Head (Eff. Eng. SN 4008155)
70277089V	1	185	Gasket Set, Complete Engine Overhaul (Eff. Eng. SN 4008155)
70277087V	1	185	Gasket Set, Intermediate (Prior to Eng. SN 4008155)
74008795V	1	185	Gasket, Cylinder Head, Cover End
74023471V	1	185	Gasket, Cylinder Head, Cover End
74008074V	1	185 Diesel	Gasket, Cylinder Head, Cover
SEALS			
74008103V	1	185	Oil Seal, Flywheel, Adapter Plate
74024561V	1	185	Front Oil Seal (Prior to Eng. SN 4008155)
74024562V	1	185	Rear Oil Seal, Flywheel Adapter Plate (Eff. Eng. SN 4008155)
CRANKSHAFT MAIN BEARINGS			
74007696V	1	185	Bearing, Rear, Upper (STD) (Eff. Eng. SN 2D-11864)
74007743V	1	185	Bearing, Rear, Upper (.010") (Eff. Eng. SN 2D-11864)
74007744V	1	185	Bearing, Rear, Upper (.020") (Eff. Eng. SN 2D-11864)
74007697V	1	185	Bearing, Rear, Lower (STD) (Eff. Eng. SN 2D-11864)
74007753V	1	185	Bearing, Rear, Lower (.010") (Eff. Eng. SN 2D-11864)
74007754V	1	185	Bearing, Rear, Lower (.020") (Eff. Eng. SN 2D-11864)
74007695V	1	185	Bearing, Front & Intermediate, Lower (STD) (Eff. Eng. SN 2D-11864)
74007759V	1	185	Bearing, Front and Intermediate, Lower (.010") (Eff. Eng. SN 2D-11864)
74007760V	1	185	Bearing, Front and Intermediate, Lower (.020") (Eff. Eng. SN 2D-11864)
70277393V	1	185	Bearing, Front & Intermediate, Upper (.010") (Eff. Eng. SN 2D-11864)
70277391V	1	185	Bearing, Front & Intermediate, Upper (.020") (Eff. Eng. SN 2D-11864)
70277394V	1	185	Bearing, Center, Upper (.010") (Eff. Eng. SN 2D-11864)
70277392V	1	185	Bearing, Center, Upper (.020") (Eff. Eng. SN 2D-11864)
74006160V	1	185	Bearing, Center, Lower (STD) (Eff. Eng. SN 2D-11864)
74006162V	1	185	Bearing, Center, Lower (.010") (Eff. Eng. SN 2D-11864)
74006164V	1	185	Bearing, Center, Lower (.020") (Eff. Eng. SN 2D-11864)
MAIN BEARING SETS			
74006063V	1	185	Bearing Kit, Main (.020")
74006061V	1	185	Bearing Kit, Main (.010")
74006059V	1	185	Bearing Kit, Main (STD)



3637034V91



70228542vv



74517334V

Liners, Pistons and Components



74006160V

Part No.	Qty	MUO	Description
----------	-----	-----	-------------

185 (EFF. SN 12800) CONTINUED

CAM SHAFT KIT

74022519V	1	185 Diesel	Camshaft Kit (Hard) (Eff. SN 2D-66200)
-----------	---	------------	--

190, 190XT, 190XT III

PISTON

74062355V	1	190, 190XT Diesel	Piston Kit
-----------	---	-------------------	------------

LINERS

74061938V	1	190, 190XT (D2900)	Liner Kit
-----------	---	--------------------	-----------

RINGS

74062157V	1	190, 190XT (D2800, D2900, G2800 & LPG)	Ring Set (Includes 3 Rings, Expander)
-----------	---	--	---------------------------------------

CONNECTING ROD BEARINGS

74007700V	4	190, 190XT	Bearing, Connecting Rod (STD) (Eff. Eng. SN 2D-11864)
-----------	---	------------	---

74007740V	4	190, 190XT	Bearing, Connecting Rod (.010")
-----------	---	------------	---------------------------------

74007741V	4	190, 190XT	Bearing Kit, Connecting Rod (.020")
-----------	---	------------	-------------------------------------

74020049V	1	190, 190XT	Connecting Rod Bushing
-----------	---	------------	------------------------

CYLINDER HEAD BOLTS

74035388V	1	190, 190XT Gas	Capscrew, Cylinder Head (short)
-----------	---	----------------	---------------------------------

74035389V	1	190, 190XT Diesel	Capscrew, Cylinder Head (long)
-----------	---	-------------------	--------------------------------

VALVES

74023378V	2	190, 190XT (G-2500, D-2800, D-2900)	Valve, Intake
-----------	---	-------------------------------------	---------------

74009936V	1	190, 190XT (G-2500, D-2800, D-2900)	Valve, Exhaust
-----------	---	-------------------------------------	----------------

74022595V	2	190, 190XT	Guide, Intake and Exhaust
-----------	---	------------	---------------------------

74026699V	1	190, 190XT	Valve, Lifter
-----------	---	------------	---------------

74035186V	6	190, 190XT	Valve Spring
-----------	---	------------	--------------

74021454V	1	190, 190XT	Plate, Thrust (Eff. Eng. SN 2G-05622, 2D-14805)
-----------	---	------------	---

ROCKER ARMS

70277421V	1	190, 190XT Diesel	Rocker Arm Assembly
-----------	---	-------------------	---------------------

74025188V	4	190, 190XT Diesel	Rocker Arm Assembly
-----------	---	-------------------	---------------------

74020185V	1	190, 190XT	Rod, Push
-----------	---	------------	-----------

ENGINE GASKETS

70277088V	1	190 Gas	Gasket Set, Complete Overhaul
-----------	---	---------	-------------------------------

70277058V	1	190 Gas	Gasket Set, Cylinder Head
-----------	---	---------	---------------------------

74008795V	1	190 Diesel	Gasket, Cylinder Head to Thermostat Housing
-----------	---	------------	---

74023471V	1	190 Diesel	Gasket, Cylinder Head (End Cover)
-----------	---	------------	-----------------------------------

70277087V	1	190 Diesel	Gasket Set, Intermediate
-----------	---	------------	--------------------------

70277089V	1	190 Diesel	Gasket Set, Engine Overhaul
-----------	---	------------	-----------------------------

74009450V	1	190 Diesel	Gasket Set, Cylinder Head
-----------	---	------------	---------------------------

74020184V	1	190, 190XT Gas	Gasket, Cylinder Head Cover
-----------	---	----------------	-----------------------------

74008074V	1	190, 190XT Diesel	Gasket, Cylinder Head Cover
-----------	---	-------------------	-----------------------------

SEALS

74024562V	1	190 Diesel	Rear Oil Seal, Flywheel, Adapter Plate
-----------	---	------------	--

74024561V	1	190	Front Oil Seal
-----------	---	-----	----------------

74008103V	1	190 Diesel	Oil Seal, (Sleeve Kit) Flywheel, Adapter Plate
-----------	---	------------	--

CRANKSHAFT MAIN BEARINGS

74007744V	1	190, 190XT	Bearing, Rear, Upper (.020") (Eff. Eng. SN 2D-11864)
-----------	---	------------	--

74007743V	1	190, 190XT	Bearing, Rear, Upper (.010") (Eff. Eng. SN 2D-11864)
-----------	---	------------	--



74006059V



74035186V

Liners, Pistons and Components

Part No.	Qty	MUO	Description
CRANKSHAFT MAIN BEARINGS CONTINUED			
74007696V	1	190, 190XT	Bearing, Rear, Upper (STD) (Eff. Eng. SN 2D-11864)
74007754V	1	190, 190XT	Bearing, Rear, Lower (.020") (Eff. Eng. SN 2D-11864)
74007753V	1	190, 190XT	Bearing, Rear, Lower (.010") (Eff. Eng. SN 2D-11864)
74007697V	1	190, 190XT	Bearing, Rear, Lower (STD) (Eff. Eng. SN 2D-11864)
74007760V	1	190, 190XT	Bearing, Front and Intermediate, Lower (.020") (Eff. Eng. SN 2D-11864)
74007759V	1	190, 190XT	Bearing, Front and Intermediate, Lower (.010") (Eff. Eng. SN 2D-11864)
74007695V	1	190, 190XT	Bearing, Front and Intermediate, Lower (STD) (Eff. Eng. SN 2D-11864)
74006164V	1	190, 190XT	Bearing, Center, Lower (.020") (Eff. Eng. SN 2D-11864)
74006162V	1	190, 190XT	Bearing, Center, Lower (.010") (Eff. Eng. SN 2D-11864)
74006160V	1	190, 190XT	Bearing, Center, Lower (STD) (Eff. Eng. SN 2D-11864)
74006063V	1	190, 190XT	Bearing Kit, Main (.020")
74006061V	1	190, 190XT	Bearing Kit, Main (.010")
74006059V	1	190, 190XT	Bearing Kit, Main (STD)
70277392V	1	190, 190XT	Bearing, Center, Upper (.020") (Eff. Eng. SN 2D-11864)
70277391V	1	190, 190XT	Bearing, Front & Intermediate, Upper (.020") (Eff. Eng. SN 2D-11864)
70277394V	1	190, 190XT	Bearing, Center, Upper (.010") (Eff. Eng. SN 2D-11864)
70277393V	1	190, 190XT	Bearing, Front & Intermediate, Upper (.010") (Eff. Eng. SN 2D-11864)
CAMSHAFT KITS			
74021902V	1	190, 190XT (G-2500, G-2800, LPG)	(Prior to Gas Eng. 2G-05437)
74022519V	1	190, 190XT Diesel	(Hard) (Eff. Diesel Eng. SN 2D-50659)
CAMSHAFT COMPONENTS			
74007964V	1	190, 190XT Gas & Diesel	Gear, Camshaft (Soft) (Prior to Diesel Eng. SN 2D-50658)
200			
PISTON			
74062359V	1	200	Piston Assembly, Includes Piston Pin, Retainer Clip & Rings (Includes 3 Rings, Expander)
LINERS			
74061938V	1	200	Sleeve Kit
74008103V	1	200	Sleeve, Oil Seal
RINGS			
74062157V	1	200	Ring Set (Includes 3 Rings, Expander)
CONNECTING ROD BEARINGS			
74007741V	4	200	Bearing Kit, Connecting Rod (.020")
74008168V	1	200	Bearing Kit, Connecting Rod (.030")
74007740V	4	200	Bearing, Connecting Rod (.010")
74007700V	4	200	Bearing, Connecting Rod (STD) (Eff. Eng. SN 2D-118646)
74020049V	1	200	Connecting Rod Bushing



74062355V



74502930V



70229718V

ENGINE

Liners, Pistons and Components

Part No.	Qty	Description
200 CONTINUED		
CYLINDER HEAD BOLTS		
74035389V	1	Capscrew, Cylinder Head (long)
74035388V	1	Capscrew, Cylinder Head (short)
VALVES		
74009936V	1	Valve, Exhaust
74023378V	2	Valve, Intake
74026699V	1	Valve, Lifter
74022595V	2	Guide, Intake and Exhaust
74035186V	6	Valve Spring
ROCKER ARMS		
74020185V	1	Rod, Push
74025188V	4	Arm Assembly, Rocker
74025188V	1	Arm Assembly, Rocker
ENGINE GASKETS		
74009450V	1	Gasket Set, Cylinder Head
70277089V	1	Gasket Set, Complete Engine Overhaul
70277087V	1	Gasket Set, Intermediate
74008795V	1	Gasket, Cylinder Head, Front (Eff. SN 74009499)
74023471V	1	Gasket, Cylinder Head, Rear
74008074V	1	Gasket, Cylinder Head Cover Diesel
SEALS		
74024561V	1	Front Oil Seal (Eff. SN 74009499)
74024562V	1	Rear Oil Seal (Eff. SN 74009499)
CRANK SHAFT MAIN BEARINGS		
74006061V	1	Bearing Kit, Main (.010")
74006063V	1	Bearing Kit, Main (.020")
74006059V	1	Bearing Kit, Main (STD)
70277391V	1	Bearing, Front & Intermediate, Upper (.020") (Eff. Eng. SN 2D-11864)
70277394V	1	Bearing, Center & Upper (.010") (Eff. Eng. SN 2D-11864)
70277392V	1	Bearing, Center & Upper (.020") (Eff. Eng. SN 2D-11864)
74006162V	1	Bearing, Center, Lower (.010")
74006164V	1	Bearing, Center, Lower (.020")
74006160V	1	Bearing, Center, Lower (STD)
70277393V	1	Bearing, Front & Intermediate, Upper (.010") (Eff. Eng. SN 2D-11864)
74007759V	1	Bearing, Front and Intermediate, Lower (.010") (Eff. Eng. SN 11864)
74007760V	1	Bearing, Front and Intermediate, Lower (.020") (Eff. Eng. SN 11864)
74007695V	1	Bearing, Front and Intermediate, Lower (STD) (Eff. Eng. SN 11864)
74007753V	1	Bearing, Rear, Lower (.010") (Eff. Eng. SN 2D-11864)

Part No.	Qty	Description
74007754V	1	Bearing, Rear, Lower (.020") (Eff. Eng. SN 2D-11864)
74007697V	1	Bearing, Rear, Lower (STD) (Eff. Eng. SN 11864)
74007743V	1	Bearing, Rear, Upper (.010") (Eff. Eng. SN 2D-11864)
74007744V	1	Bearing, Rear, Upper (.020") (Eff. Eng. SN 2D-11864)
74007696V	1	Bearing, Rear, Upper (STD) (Eff. Eng. SN 2D-11864)
TIMING		
74022519V	1	Camshaft Kit (Hard)
74021454V	1	Plate, Thrust
210		
RINGS		
74062401V	1	Ring Set
SLEEVES		
74037221V	1	Sleeve
CONNECTING ROD BEARINGS		
74036261V	2	Bearing, Connecting Rod (STD)
74036426V	1	Bearing, Connecting Rod (.010")
74036427V	1	Bearing, Connecting Rod (.020")
74036429V	1	Bearing, Connecting Rod (.040")
74025031V	6	Connecting Rod Bushing
CYLINDER HEAD BOLTS		
74035388V	1	Capscrew, Cylinder Head (short)
74035389V	1	Capscrew, Cylinder Head (long)
VALVES		
74036609V	2	Exhaust Valve (Eff. SN 3D-16241)
74037135V	2	Valve Intake (Eff. SN 3D-16241)
74022595V	2	Guide, Intake and Exhaust (Eff. SN 3D-13602)
74026699V	1	Valve, Lifter
ROCKER ARMS		
70277421V	1	Arm Assembly, Rocker
74025188V	4	Arm Assembly, Rocker
74028110V	2	Rod, Push
ENGINE GASKETS		
74035214V	1	Gasket, Cylinder Head
70277040V	1	Gasket Set, Cylinder Head
74037120V	1	Gasket Set, Complete Overhaul
70277414V	1	Gasket Set, Cylinder Head
SEALS		
74029556V	1	Wear Sleeve, Flywheel
74062088V	1	Seal, Oil, Flywheel
74036340V	1	Front Oil Seal, Crankshaft
CRANKSHAFT MAIN BEARINGS		
74035009V	1	Bearing, Rear & Center, Upper (STD)
74035047V	2	Bearing, Rear & Center, Upper (.010")
74035048V	1	Bearing, Rear & Center, Upper (.020")
74035010V	1	Bearing, Rear & Center, Lower (STD)
74035052V	1	Bearing, Rear & Center, Lower (.010")

Liners, Pistons and Components

Part No.	Qty	Description
CRANKSHAFT MAIN BEARINGS CONTINUED		
74035053V	1	Bearing, Rear & Center, Lower (.020")
74035037V	1	Bearing, Front & Intermediate, Upper (.010")
74035038V	1	Bearing, Front & Intermediate, Upper (.020")
74035008V	1	Bearing, Front & Intermediate, Lower
74035042V	1	Bearing, Front & Intermediate, Lower
74035043V	1	Bearing, Front & Intermediate, Lower
CAMSHAFT		
74029000V	1	Camshaft
CAMSHAFT COMPONENTS		
74021454V	1	Plate, Thrust, Camshaft
70935121V	1	O-Ring, Oil Tube
220, 220 FWA		
PISTONS		
74036680V	1	Piston
LINERS		
74037221V	1	Sleeve (Eff. Eng. SN 3D-12401)
RINGS		
74062401V	1	Ring Set
CONNECTING ROD BUSHINGS & HARDWARE		
74035388V	1	Bolt, Cylinder Head (short)
74035389V	1	Bolt, Cylinder Head (long)
74025031V	6	Connecting Rod Bushing
CONNECTING ROD BEARINGS		
74036261V	2	Bearing, Connecting Rod (STD)
74036426V	1	Bearing, Connecting Rod (.010")
74036427V	1	Bearing, Connecting Rod (.020")
74036429V	1	Bearing Kit, Connecting Rod (.040")
CYLINDER HEAD VALVES		
74036609V	2	Valve, Exhaust (Eff. Eng. SN 3D-16241)
74037135V	2	Valve, Intake (Eff. Eng. SN 3D-16241)
74035186V	6	Valve Spring
74022595V	2	Guide, Intake and Exhaust (Eff. Eng. SN 3D-13602)

Part No.	Qty	Description
ROCKER ARM ASSEMBLY		
70277421V	1	Rocker Arm Assembly
74025188V	4	Rocker Arm Assembly
74021454V	1	Plate, Thrust
74026699V	1	Valve, Lifter
70935121V	1	O-Ring, Oil Tube
74028110V	2	Rod, Push
ENGINE GASKETS		
74035214V	1	Gasket, Cylinder Head
70277040V	1	Gasket Set, Cylinder Head
74037120V	1	Gasket Set, Complete Overhaul
70277414V	1	Gasket
SEALS		
74029556V	1	Wear Sleeve
74062088V	1	Seal, Oil, Flywheel
74036340V	1	Seal Kit, Oil, Crankshaft
CRANKSHAFT MAIN BEARINGS		
74035009V	1	Bearing, Rear & Center, Upper (STD)
74035048V	1	Bearing, Rear & Center, Upper (.020")
74035047V	2	Bearing, Rear & Center, Upper (.010")
74035010V	1	Bearing, Rear & Center, Lower (STD)
74035053V	1	Bearing, Rear & Center, Lower (.020")
74035052V	1	Bearing, Rear & Center, Lower (.010")
74035038V	1	Bearing, Front & Intermediate, Upper (.020")
74035037V	1	Bearing, Front & Intermediate, Upper (.010")
74035043V	1	Bearing, Front & Intermediate, Lower (.020")
74035042V	1	Bearing, Front & Intermediate, Lower (.010")
74035008V	1	Bearing, Front & Intermediate, Lower (STD)
CAMSHAFT		
74029000V	1	Camshaft

ENGINE

Part No.	Qty	MUO	Description
5000 SERIES			
PISTONS			
72094302V	1	5040	Piston (STD)
72094369V	1	5045	Piston Kit (STD) Includes: 1-Piston, 1-Ring Set (3 per set) 2-Retaining Rings, 1-Piston Pin, 1-Half-Bearing Set
72094323V	1	5050	Piston (STD) (Eng. SN 700000 - 799999, and Eff. Eng. SN 200000)



70241527V

Liners, Pistons and Components

Part No.	Qty	MUO	Description
5000 SERIES CONTINUED			
LINERS			
72091478V	1	5050	Sleeve (.2")
72091473V	1	5050	Sleeve (Eng. SN 700000 - 799999)
72090603V	1	5045, 5050	Sleeve (Eng. SN 600000 - 699999)
72090604V		5045, 5050	Sleeve (Eng. SN 600000 - 699999) (0.2mm)
RINGS			
72093006V	1	5050	Ring Set (STD) (9 rings per set) (Eng. SN 700000 - 799999, Eff. Eng. SN 200000)
72094303V	1	5040	Ring Set, (STD) (3 rings per kit) (Eng. SN 700000 - 799999)
1908737V	1	5045, 5050	Ring Set (STD) (3 rings per kit)
CONNECTING ROD			
72093818V	1	5040, 5045, 5050	Connecting Rod Bolt
72089460V	1	5040, 5045, 5050	Connecting Rod Bushing
72094161V	1	5040, 5045, 5050	Connecting Rod (Eng. SN 600000 - 699999) (Includes Adjustment Screw and Bushing)
CONNECTING ROD BEARINGS			
72094399V	1	5040, 5045, 5050	Connecting Rod Bearing Set (STD) (Eng. SN 600000 - 699999)
72094293V	1	5050	Connecting Rod
72089669V	1	5040, 5045, 5050	Valve, Exhaust
72094310V	1	5040, 5045, 5050	Intake Valve
CYLINDER HEAD VALVES			
72094309V	1	5040, 5045, 5050	Guide, Valve (STD)
70932221V	1	5040, 5045, 5050	Lock Cone (M 7.85 X 10)
ENGINE GASKETS			
4849994V	1	5040 5045, 5050	Gasket, Rear Timing Gear (6 & 9 Speed)
98461684V	1	5040, 5045, 5050	Gasket, Front Timing Gear
72094441V	1	5040, 5045, 5050	Gasket, Valve Cover
98499494V	1	5040	Gasket, Cylinder Head (6 & 9 Speed)
98472011V	1	5050	Gasket, Cylinder Head (Eng. SN 700000 - 799999)
1940098V	1	5050	Gasket Set, Major Overhaul (Eng. SN 700000 - 799999)
1940099V	1	5040	Gasket Set, Major Overhaul (8 & 12 Speed)
1940064V	1	5045	Gasket Set, Cylinder Head (Eng. SN 987934 - 989000) (UTB MFG. Engine)
1940068V	1	5045	Gasket Set, Major Overhaul (Eng. SN 987934 - 989000) (UTB MFG. Engine)
98472006V	1	5045, 5050	Gasket Set, Cylinder Head
SEALS			
72091451V	1	5045, 5050	Seal, Crankshaft, Rear (135mm OD)
98461686V	1	5045	5050 Rear Oil Seal, Cover (Eff. Tractor SN 989001, Italian)
CRANKSHAFT ASSEMBLY			
72094402V	1	5045	Includes Key & Plug (Eff. Eng. SN 989001, Italian MFG. Eng.)
72094402V	1	5050	Crankshaft Assembly Includes Key (Eng. SN 700000-799999, Eff. Eng. SN 200000)

Liners, Pistons and Components

Part No.	Qty	MUO	Description
MAIN BEARINGS			
72094147V	1	5040, 5045, 5050	Ring, Half Set, Upper & Lower (0.127") (Eng. SN 600000 - 699999)
72094146V	1	5040, 5045, 5050	Ring, Half Set, Upper & Lower (STD) (Eng. SN 600000 - 699999)
72094304V	1	5040, 5045, 5050	Half Bearing (-0.508") (Eng. SN 600000 - 699999)
72094355V	1	5040, 5045, 5050	Bearing, Upper (-0.508" Undersize) (Eng. SN 700000 - 799999, Eff. Engine SN 200000)
4718618V	1	5040, 5045, 5050	Bushing, Front
4718620V	1	5040, 5045, 5050	Bushing, Rear
CRANKCASE ASSEMBLY			
10160704V	1	5040, 5045, 5050	Plug
6000 SERIES			
PISTONS			
743824V91	1	6040	Piston Assembly
74062359V	1	6060, 6070, 6080	Piston Assembly
LINERS			
74061938V	1	6060, 6070, 6080	Liner Kit
4231513V	1	6150	Liner, Cylinder
739043V1	1	6040	Liner
RINGS			
2230216V	1	6150	Ring, Intermediate
836325V91	1	6040	Piston Ring Set
74062157V	1	6060, 6070, 6080	Ring Set (Includes 3 Rings, Expander)
CONNECTING RODS			
3637392V91	1	6040	Connecting Rod
CONNECTING ROD BUSHINGS & HARDWARE			
3371612V	1	6150, 6060, 6070, 6080	Connecting Rod Bushing
740407V1	1	6040	Connecting Rod Bushing
1476245V1	1	6040	Nut, Connecting Rod
375756V1	1	6040	Bolt, Connecting Rod
4157075V	1	6150	Bolt, Connecting Rod
2137750V	1	6150	Bearing, Connecting Rod (60mm)
4231896V	1	6150	Bearing, Connecting Rod (59.75mm)
74007700V	4	6060, 6070, 6080	Bearing, Connecting Rod (STD)
74008168V	1	6060, 6070, 6080	Bearing Kit, Connecting Rod (.030") (Includes 8 Bearings)
74007741V	4	6060, 6070, 6080	Bearing Kit, Connecting Rod (.020") (Includes 8 Bearings)
74007740V	4	6060, 6070, 6080	Bearing Kit, Connecting Rod (.010") (Includes 8 Bearings)
737070V91	1	6040	Set, Connecting Rod Bearing (STD)
737072V91	1	6040	Set, Bearing, Connecting Rod (.020")
CYLINDER HEAD ASSEMBLIES			
4222810V91	1	6040	Kit, Cylinder Head Assembly (Includes Valves, Springs, Seats, Caps)
CYLINDER HEAD BOLTS			
3371666V	1	6150	Washer, Cylinder Head
1216307V	1	6150	Washer, Cylinder Head
74035388V	1	6060, 6070, 6080	Bolt, Cylinder Head (short)
74035389V	1	6060, 6070, 6080	Bolt, Cylinder Head (long)
2101681V	1	6150	Bolt, Cylinder Head (short)



70227500V

Liners, Pistons and Components

Part No.	Qty	MUO	Description
----------	-----	-----	-------------

6000 SERIES CONTINUED

VALVES

737640V1	1	6040	Valve, Exhaust
74009936V	1	6060, 6070, 6080	Valve, Exhaust
2108102V	1	6150	Valve, Exhaust
74023378V	2	6060, 6070, 6080	Valve, Intake
732811V1	1	6040	Valve, Intake
731154V1	1	6040	Valve Spring
74035186V	6	6060, 6070, 6080	Valve Spring
3369305V	1	6150	Compression Spring
732445V1	1	6040	Guide, Intake and Exhaust
2232528V	1	6150	Guide, Intake and Exhaust
74022595V	1	6060, 6070, 6080	Guide, Intake and Exhaust
74026699V	1	6060, 6070, 6080	Valve, Lifter
2137302V	1	6150	Valve Seat (STD) (45.66mm)
2137306V	1	6150	Valve Seat (40.16mm)
1168817V	1	6150	Lock, Valve
731155V1	10	6040	Lock, Valve

ROCKER ARMS

731150V1	1	6040	Tappet, Valve
3371885V	1	6150	Tappet, Valve
74020185V	1	6060	Rod, Push
74020185V	1	6070	Rod, Push
74020185V	1	6080	Rod, Push
2237661V	1	6150	Bushing, Valve Mechanism
70277421V	1	6060, 6070, 6080	Arm Assembly, Rocker
74025188V	4	6060, 6070, 6080	Arm Assembly, Rocker
2232840V	1	6150	Valve Seal

SHIMS - CYLINDER

4231432V	1	6150	Shim (0.05mm)
2137256V	1	6150	Shim, (0.02mm)

ENGINE GASKETS

4223567V1	1	6040	Gasket, Timing Gear Cover
3641399V91	1	6040	Gasket, Cylinder Head Cover
3371692V	1	6150	Gasket, Cylinder Head Cover
70277087V	1	6060, 6070, 6080	Gasket Set, Intermediate
4222480V91	1	6040	Gasket Kit, Cylinder Head
735057V1	1	6040	Gasket

SEALS

74008103V	1	6060, 6070, 6080	Oil Seal, Sleeve Kit (Flywheel Adapter Plate)
735866V1	2	6040	Rear Oil Seal, Crankshaft
74024562V	1	6060, 6070, 6080	Rear Oil Seal, (Flywheel Adapter Plate)
74024561V	1	6060, 6070, 6080	Front Oil Seal
4152348V	1	6150	Seal, Front Crankcase
4230392V	1	6150	Seal, Front Crankcase

CRANKSHAFT MAIN BEARINGS

746156V91	1	6040	Set, Main Bearings (STD)
74007696V	1	6080	Bearing, Rear, Upper (STD)
74007744V	1	6060, 6070, 6080	Bearing, Rear, Upper (.020")
74007743V	1	6060, 6070, 6080	Bearing, Rear, Upper (.010")
74007696V	1	6060, 6070	Bearing, Rear, Upper
74007697V	1	6060, 6070, 6080	Bearing, Rear, Lower (STD)
74007754V	1	6060, 6070, 6080	Bearing, Rear, Lower (.020")
74007753V	1	6060, 6070, 6080	Bearing, Rear, Lower (.010")



74007697V



74007700V

Liners, Pistons and Components

Part No.	Qty	MUO	Description
CRANKSHAFT MAIN BEARINGS CONTINUED			
3362379V	1	6150	Bearing, Main (70 mm) (STD)
3362380V	1	6150	Bearing, Main (69.75mm)
3362381V	1	6150	Bearing, Main, (69.50mm)
74007695V	1	6060, 6070, 6080	Bearing, Front and Intermediate, Lower (STD)
74007760V	1	6060, 6070, 6080	Bearing, Front and Intermediate, Lower (.020")
74007759V	1	6060, 6070, 6080	Bearing, Front and Intermediate, Lower (.010")
74007694V	1	6060, 6070, 6080	Bearing, Front & Intermediate, Upper (STD)
74007746V	1	6060, 6070, 6080	Bearing, Front & Intermediate, Upper (.010")
74006161V	1	6060, 6070, 6080	Bearing, Center, Upper (.010")
74006160V	1	6060, 6070, 6080	Bearing, Center, Lower (STD)
74006164V	1	6060, 6070, 6080	Bearing, Center, Lower (.020")
74006162V	1	6060, 6070, 6080	Bearing, Center, Lower (.010")
THRUST WASHERS			
735800V1	1	6040	Washer, Thrust, Rear Main Bearing, Top
735112V1	1	6040	Washer, Thrust, Rear Main Bearing
CRANKSHAFT COMPONENTS			
3641826V1	1	6040	Crankshaft Gear
FLYWHEEL			
731988V1	1	6040	Ring Gear, Flywheel
731192V1	1	6040	Lockplate (Coupling to Flywheel)
2131081V	1	6150	Ring Gear, Flywheel
72505492V	1	6060, 6070, 6080	Bearing, Flywheel
ENGINE BLOCK			
731354V1	1	6040	Plug, Water Jacket (Front)
731356V1	1	6040	Plug (11/16") Pressure Rail
TIMING			
74021454V	1	6060, 6070, 6080	Plate, Thrust
3637541V1	1	6040	Camshaft Gear (Teeth/Splines: 50)
733507V1	1	6040	Camshaft
2237665V	1	6150	Bushing, Camshaft Mechanism
2139737V	1	6150	Bushing, Camshaft
7000 SERIES			
PISTONS			
74062359V	1	7000, 7010, 7020	Piston Assembly (Includes Ring Set, Pin, Retainer)
74036680V	1	7030, 7040, 7045, 7050, 7060, 7080, 7580	Piston Assembly (Includes Ring Set, Pin, Retainer)
4159904V	1	7120, DX6.50, 7145, DX7.10	Piston (102mm)
4152183V	1	7110, DX6.30	Piston (STD)
4151131V	1	7085, DX4.70	Piston (STD)
4157748V	1	7110, DX6.30	Piston (102mm) (4.0157")
PISTON & SLEEVE KIT			
74037221V	1	7030, 7040, 7045, 7050, 7060, 7080, 7580	Piston & Sleeve Kit
LINERS			
74061938V	1	7000, 7010, 7020	Sleeve Kit
RING SET			
74062157V	1	7000, 7010, 7020, DX6.50	Ring Set (Includes 3 Rings, Expander)
74062401V	1	7030, 7040, 7045, 7050, 7060, 7080, 7580	Ring Set (Includes 3 Rings, Expander)



733507V1

Liners, Pistons and Components



74037221V

ENGINE



74036609V

Part No.	Qty	MUO	Description
7000 SERIES CONTINUED			
RING SET CONTINUED			
2230216V	1	7085, DX4.70, 7110, DX6.30, 7120, DX6.50	Ring, Intermediate
2235561V	1	7085, DX4.70, 7110, DX6.30	Ring Set (STD)
4152185V	1	7110, DX6.30	Ring Set (102mm) (4.0157")
4158321V	1	7145, DX7.10	Ring, Intermediate
CONNECTING ROD BUSHINGS & HARDWARE			
74025031V	6	7030, 7040, 7045, 7050, 7060, 7080, 7580	Connecting Rod Bushing
74020049V	1	7000, 7010, 7020	Connecting Rod Bushing
3371612V	1	7085, DX4.70, 7110, DX6.30	Connecting Rod Bushing (small end)
2138563V	1	7120, DX6.50, 7145, DX7.10	Connecting Rod Bushing (small end)
4157075V	1	7110, DX6.30, 7120, DX6.50, 7145, DX7.10, 7145, DX7.10	Connecting Rod Bolt
CONNECTING ROD BEARINGS			
74036261V	2	7030, 7040 (Eff. SN 70-15285), 7045 (Eff. SN 70-15285), 7050, 7060, 7080, 7580 (Eff. SN 70-15285)	Bearing, Connecting Rod (STD)
74007700V	4	7010, 7020	Bearing, Rod (STD) (Prior to Eng. SN 20-11864)
74036427V	1	7030, 7040 (Eff. SN 70-15285), 7045 (Eff. SN 70-15285), 7050, 7060, 7080 (Eff. SN 70-15285), 7580 (Eff. SN 70-15285)	Bearing, Connecting Rod (.020")
74007740V	4	7010, 7020	Bearing, Connecting Rod (.010")
74036426V	1	7030, 7040 (Eff. SN 70-15285), 7045 (Eff. SN 70-15285), 7050, 7060, 7080 (Eff. SN 70-15285), 7580 (Eff. SN 70-15285)	Bearing, Connecting Rod (.010")
74062337V	1	7030, 7040 (Eff. SN 70-15285), 7045 (Eff. SN 70-15285), 7050, 7060, 7080 (Eff. SN 70-15285), 7580 (Eff. SN 70-15285)	Bearing Kit, Connecting Rod (STD)
74036429V	1	7030, 7040 (Eff. SN 70-15285), 7045 (Eff. SN 70-15285), 7050, 7060, 7080 (Eff. SN 70-15285), 7580 (Eff. SN 70-15285)	Bearing Kit, Connecting Rod (.040")
74008168V	1	7010, 7020	Bearing Kit, Connecting Rod (.030")
74007741V	4	7010, 7020	Bearing Kit, Connecting Rod (.020")
74062516V	1	7030, 7040 (Eff. SN 70-15285), 7045 (Eff. SN 70-15285), 7050, 7060, 7080 (Eff. SN 70-15285), 7580 (Eff. SN 70-15285)	Bearing Kit, Connecting Rod (.020")
74062515V	1	7030, 7040 (Eff. SN 70-15285), 7045 (Eff. SN 70-15285), 7050, 7060, 7080 (Eff. SN 70-15285), 7580 (Eff. SN 70-15285)	Bearing Kit, Connecting Rod (.010")

Liners, Pistons and Components

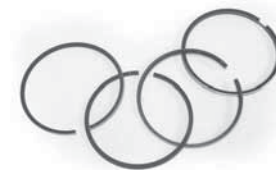

74062401V

Part No.	Qty	MUO	Description
CONNECTING ROD BEARINGS CONTINUED			
2137750V	1	7085, DX4.70, 7110, DX6.30	Bearings, Connecting Rod (60mm)
2235236V	1	7120, DX6.50	Bearing Set, Connecting Rod
4231896V	1	7085, DX4.70, 7110, DX6.30	Bearing, Connecting Rod (59.75mm)
74007700V	4	7000	Bearing, Connecting Rod (STD)
74007744V	1	7000, 7010, 7020	Bearing, Rear, Upper (.020")
74007743V	1	7000, 7010, 7020	Bearing, Rear, Upper (.010")
2235183V	1	7120, DX6.50, 7145, DX7.10	Bearing, Connecting Rod (big end) (66mm) (2.5984")
2235204V	1	7120, DX6.50, 7145, DX7.10	Bearing, Connecting Rod (big end) (65.75mm) (2.5886")
2235207V	1	7120, DX6.50, 7145, DX7.10	Bearing, Connecting Rod (big end) (65.50mm) (2.5787")
74007740V	4	7000	Bearing, Connecting Rod (.010")
74008168V	1	7000	Bearing Kit, Connecting Rod (.030")
74007741V	4	7000	Bearing Kit, Connecting Rod (.020")
CYLINDER HEAD ASSEMBLY			
4231513V	1	7085, DX4.70, 7110, DX6.30, 7120, DX6.50	Cylinder Assembly
4231519V	1	7145, DX7.10	Cylinder Assembly (102mm)
4230614V	1	7110, DX6.30	Head, Cylinder
CYLINDER HEAD HARDWARE			
74035388V	1	7000, 7010, 7020, 7030, 7040, 7045, 7050, 7060, 7080, 7580	Bolt, Cylinder Head (short)
74035389V	1	7000, 7010, 7020, 7030, 7040, 7045, 7050, 7060, 7080, 7580	Bolt, Cylinder Head (long)
2101681V	1	7085, DX4.70, 7110, DX6.30, 7120, DX6.50	Bolt, Cylinder Head
2238632V	1	7145, DX7.10	Bolt, Cylinder Head
3371666V	1	7085, DX4.70, 7110, DX6.30, 7120, DX6.50, 7145, DX7.10	Washer, Cylinder Head Bolt
1216307V	1	7085, DX4.70, 7110, DX6.30, 7120, DX6.50, 7145, DX7.10	Washer, Cylinder Head Bolt Shims
4231433V	1	7085, DX4.70, 7110, DX6.30, 7120, DX6.50, 7145, DX7.10	Shim (0.8mm)
4231432V	1	7085, DX4.70, 7110, DX6.30, 7120, DX6.50, 7145, DX7.10	Shim (0.05mm)
2137256V	1	7085, DX4.70, 7110, DX6.30, 7120, DX6.50, 7145, DX7.10	Shim (0.02mm)
VALVES			
74009936V	1	7010, 7020	Valve, Exhaust
74036609V	2	7030, 7040, 7045, 7050, 7060 (Eff. SN 13999), 7080 (Eff. SN 70-13999), 7580 (Eff. SN 13999)	Valve, Exhaust
74009936V	1	7000	Valve, Exhaust
4159139V	1	7085, DX4.70, 7110, DX6.30, 7120, DX6.50, 7145, DX7.10	Valve, Exhaust
4153697V	1	7110, DX6.30, 7120, DX6.50, 7145, DX7.10, 7145, DX7.10	Exhaust Valve
2108102V	1	7085, DX4.70, 7110, DX6.30, 7120, DX6.50, 7145, DX7.10	Exhaust Valve
74023378V	2	7000, 7010, 7020	Valve, Intake
74037135V	2	7030, 7040, 7045, 7050, 7060, 7080, 7580	Valve, Intake

Liners, Pistons and Components

Part No.	Qty	MUO	Description
7000 SERIES CONTINUED			
VALVES CONTINUED			
4153631V	1	7085, DX4.70, 7110, DX6.30, 7120, DX6.50	Valve, Intake
4159136V	1	7085, DX4.70, 7110, DX6.30, 7120, DX6.50	Valve, Intake
3369305V	1	7085, DX4.70, 7110, DX6.30, 7120, DX6.50, 7145, DX7.10	Valve Spring
74035186V	6	7000, 7010, 7020, 7030, 7040, 7045, 7050, 7060 (Eff. SN 3D-30829), 7080, 7580	Valve Spring
74022595V	2	7000, 7010, 7020, 7030, 7040, 7045, 7050, 7060, 7080, 7580	Guide, Intake and Exhaust
2232528V	1	7085, DX4.70, 7110, DX6.30, 7120, DX6.50, 7145, DX7.10	Guide, Intake and Exhaust
2137302V	1	7085, DX4.70, 7110, DX6.30, 7120, DX6.50, 7145, DX7.10	Valve Seat (STD) (45.66mm)
2137306V	1	7085, DX4.70, 7110, DX6.30, 7120, DX6.50, 7145, DX7.10	Valve Seat (40.16mm)
2232840V	1	7085, DX4.70, 7110, DX6.30, 7120, DX6.50, 7145, DX7.10	Valve Seal
ROCKER ARMS			
74026699V	1	7000, 7010, 7020, 7030, 7040, 7045, 7050, 7060, 7080, 7580	Valve, Lifter
3371885V	1	7085, DX4.70, 7110, DX6.30, 7120, DX6.50, 7145, DX7.10, 7145, DX7.10	Tappet, Valve
1168817V	1	7085, DX4.70, 7110, DX6.30, 7120, DX6.50, 7145 DX7.10	Tappet, Valve
74028110V	2	7030, 7040, 7050, 7060, 7080, 7580	Rod, Push
74020185V	1	7000, 7010, 7020	Rod, Push
74021454V	1	7000, 7010, 7020, 7030, 7040, 7045, 7050, 7060, 7080, 7580	Plate, Thrust
70935121V	1	7030, 7040, 7045, 7050, 7060, 7080, 7580	O-Ring, Oil Tube
2237661V	1	7085, DX4.70, 7110, DX6.30, 7120, DX6.50, 7145, DX7.10	Bushing, Valve Mechanism
2237665V	1	7085, DX4.70, 7110, DX6.30, 7120, DX6.50, 7145, DX7.10	Bushing, Shaft Mechanism
70277421V	1	7000, 7010, 7020, 7030, 7040, 7045, 7050, 7060, 7080, 7580	Arm Assembly, Rocker
74025188V	4	7000, 7010, 7020, 7030, 7040, 7045, 7050, 7060, 7080, 7580	Arm Assembly, Rocker
ENGINE GASKET SETS			
3362337V	1	7085, DX4.70, 7110, DX6.30, 7120, DX6.50, 7145, DX7.10	Gasket, Rear Cover
74023471V	1	7010, 7020	Gasket, Cylinder Head, End
74008795V	1	7010, 7020	Gasket, Cylinder Head, End
74008074V	1	7010, 7020 Diesel	Gasket, Cylinder Head Cover
74008074V	1	7000 Diesel	Gasket, Cylinder Head Cover
74035214V	1	7030, 7040, 7045, 7050, 7060, 7080, 7580	Gasket, Cylinder Head Cover

Liners, Pistons and Components

Part No.	Qty	MUO	Description
ENGINE GASKET SETS CONTINUED			
3371692V	5	7085, DX4.70, 7110, DX6.30, 7120, DX6.50, 7145, DX7.10	Gasket, Cylinder Head Cover
74023471V	1	7000	Gasket, Cylinder Head (End Cover)
74008795V	1	7000	Gasket, Cylinder Head (End Cover)
2928994V	1	7085, DX4.70, 7110, DX6.30, 7120, DX6.50, 7145, DX7.10	Gasket Set, Single Cylinder
70277087V	1	7000	Gasket Set, Intermediate
70277089V	1	7010, 7020	Gasket Set, Engine Overhaul
70277040V	1	7030, 7040, 7045, 7050, 7060, 7080, 7580	Gasket Set, Cylinder Head
74009450V	1	7010, 7020	Gasket Set, Cylinder Head
70277414V	1	7030, 7040, 7045, 7050, 7060, 7080, 7580	Gasket Set, Cylinder Head
74009450V	1	7000	Gasket Set, Cylinder Head
70277089V	1	7000	Gasket Set, Complete Overhaul
2929657V	1	7120, DX6.50, 7145, DX7.10	Gasket Set, Complete Overhaul
2929638V	1	7085, DX4.70	Gasket Set, Complete Overhaul
74037120V	1	7030, 7040, 7045, 7050, 7060, 7080, 7580	Gasket Set, Complete Overhaul
SEALS			
74008103V	1	7010, 7020	Sleeve Kit, Oil Seal (Flywheel, Adapter Plate)
74029556V	1	7030, 7040, 7045, 7050, 7060, 7080, 7580	Sleeve Kit, Oil Seal (Flywheel, Adapter Plate)
74024562V	1	7000, 7010, 7020	Seal, Oil, Rear
74062088V	1	7030, 7040, 7045, 7050, 7060, 7080, 7580	Seal, Oil (Flywheel)
74024561V	1	7000, 7010, 7020	Seal, Oil
4230392V	1	7085, DX4.70, 7110, DX6.30, 7120, DX6.50, 7145, DX7.10	Seal, Front Crankcase
4152348V	1	7085, DX4.70, 7110, DX6.30, 7120, DX6.50, 7145, DX7.10,	Seal, Front Crankcase
74036340V	1	7030, 7040, 7045, 7050, 7060, 7080, 7580	Seal, Front Crankcase
2230203V	1	7120, DX6.50, 7145, DX7.10	Stop Ring (3.50mm) (.1378")
2230198V	1	7120, DX6.50, 7145, DX7.10	Stop Ring (3.50mm) (.1378")
2230183V	1	7085, DX4.70, 7110, DX6.30	Stop Ring (3.50mm) (.1378")
2230173V	1	7085, DX4.70, 7110, DX6.30	Stop Ring (3.50mm) (.1378")
2230202V	1	7120, DX6.50, 7145, DX7.10	Stop Ring (3.25mm) (.1279")
2230197V	1	7120, DX6.50, 7145, DX7.10	Stop Ring (3.25mm) (.1279")
2230182V	1	7085, DX4.70, 7110, DX6.30	Stop Ring (3.25mm) (.1279")
2230172V	1	7085, DX4.70, 7110, DX6.30	Stop Ring (3.25mm) (.1279")
2230201V	1	7120, DX6.50, 7145, DX7.10	Stop Ring (3mm) (.1181")
2230196V	1	7120, DX6.50, 7145, DX7.10	Stop Ring (3mm) (.1181")
2230181V	1	7085, DX4.70, 7110, DX6.30	Stop Ring (3mm) (.1181")
2230170V	1	7085, DX4.70, 7110, DX6.30	Stop Ring (3mm) (.1181")
MAIN BEARINGS			
74061650V	1	7030, 7040, 7045, 7050, 7060, 7080, 7580	Bearing Kit, Main (.020")
74061649V	1	7030, 7040, 7045, 7050, 7060, 7080, 7580	Bearing Kit, Main (.010")

Liners, Pistons and Components

ENGINE



74009936V

Part No.	Qty	MUO	Description
7000 SERIES CONTINUED			
MAIN BEARINGS CONTINUED			
74061642V	1	7030, 7040, 7045, 7050, 7060, 7080, 7580	Bearing Set, Main (STD)
74035053V	1	7030, 7040, 7045, 7050, 7060, 7080, 7580	Bearing, Rear & Center, Lower (.020")
74035052V	1	7030, 7040, 7045, 7050, 7060, 7080, 7580	Bearing, Rear & Center, Lower (.010")
74035048V	1	7030, 7040, 7045, 7050, 7060, 7080, 7580	Bearing, Rear & Center, Upper (.020")
74035047V	2	7030, 7040, 7045, 7050, 7060, 7080, 7580	Bearing, Rear & Center, Upper (.010")
74035043V	1	7030, 7040, 7045, 7050, 7060, 7080, 7580	Bearing, Front & Intermediate, Lower (.020")
74035042V	1	7030, 7040, 7045, 7050, 7060, 7080, 7580	Bearing, Front & Intermediate, Lower (.010")
74035038V	1	7030, 7040, 7045, 7050, 7060, 7080, 7580	Bearing, Front & Intermediate, Upper (.020")
74035037V	1	7030, 7040, 7045, 7050, 7060, 7080, 7580	Bearing, Front & Intermediate, Upper (.010")
74035010V	1	7030, 7040, 7045, 7050, 7060, 7080, 7580	Bearing, Rear & Center, Lower (STD)
74035009V	1	7030, 7040, 7045, 7050, 7060, 7080, 7580	Bearing, Rear & Center, Upper (STD)
74035008V	1	7030 (Eff. SN 3D-36374), 7040, 7045, 7050 (Eff. SN 3D-36374), 7060 (Eff. SN 3D-36374), 7080, 7580	Bearing, Front & Intermediate, Lower (STD)
74035007V	1	7030, 7040, 7045, 7050, 7060, 7080, 7580	Bearing, Front & Intermediate, Upper (STD)
74007760V	1	7000, 7010, 7020	Bearing, Front & Intermediate, Lower (.020")
74007759V	1	7000, 7010, 7020	Bearing, Front & Intermediate, Lower (.010")
74007754V	1	7000, 7010, 7020	Bearing, Rear, Lower (.020")
74007753V	1	7000, 7010, 7020	Bearing, Rear, Lower (.010")
74007746V	1	7010, 7020	Bearing, Front & Intermediate, Upper (.010")
74007697V	1	7000, 7010, 7020	Bearing, Rear, Lower (STD)
74007696V	1	7000, 7010, 7020	Bearing, Rear, Upper (STD)
74007695V	1	7000, 7010, 7020	Bearing, Front & Intermediate, Lower
74007694V	1	7010, 7020	Bearing, Front & Intermediate, Upper (STD)
74006164V	1	7000, 7010, 7020	Bearing, Center, Lower (.020")
74006162V	1	7000, 7010, 7020	Bearing, Center, Lower (.010")
74006161V	1	7010, 7020	Bearing, Center, Upper (.010")
74006160V	1	7000, 7010, 7020	Bearing, Center, Lower (STD)
74006159V	1	7010, 7020	Bearing, Center, Upper (STD)
74006068V	1	7010, 7020	Bearing Kit, Main (.020")
74006067V	1	7010, 7020	Bearing Kit, Main (.010")
74006066V	1	7010, 7020	Main Bearing Kit (STD)
74006063V	1	7000	Bearing Kit, Main (.020")

Liners, Pistons and Components

Part No.	Qty	MUO	Description
MAIN BEARINGS CONTINUED			
74006061V	1	7000	Bearing Kit, Main (.010")
74006059V	1	7000	Bearing Kit, Main (STD)
70277394V	1	7000	Bearing, Center & Upper (.010")
70277393V	1	7000	Bearing, Front & Intermediate, Upper (.010")
70277392V	1	7000	Bearing, Center, Upper (.020")
70277391V	1	7000	Bearing, Front & Intermediate, Upper (.020")
3362381V	1	7085, DX4.70, 7110, DX6.30	Bearing, Main (69.50mm)
3362380V	1	7085, DX4.70, 7110, DX6.30	Bearing, Main (69.75mm)
3362379V	1	7085, DX4.70, 7110, DX6.30	Bearing, Main (70mm) (STD)
2235192V	1	7120, DX6.50, 7145, DX7.10	Bearing, Main (74.50mm) (2.933")
2235189V	1	7120, DX6.50, 7145, DX7.10	Bearing, Main (74.75mm) (2.9429")
2235185V	1	7120, DX6.50, 7145, DX7.10	Bearing, Main (75mm)
FLYWHEEL			
2249939V	1	7120, DX6.50 (Eff. 7440/3179 & 7441/3576)	Flywheel (50mm x 372mm)
2131081V	1	7085, DX4.70, 7110, DX6.30, 7120, DX6.50, 7145, DX7.10	Ring Gear (Flywheel)
PULLEY			
4158486V	1	7110, DX6.30	Pulley, V-Belt (Crankshaft)
TIMING CAMSHAFT			
74022519V	1	7000, 7010, 7020	Camshaft Kit (hard)
74029000V	1	7030, 7040, 7045, 7050, 7060, 7080, 7580	Camshaft
2139737V	1	7085, DX4.70, 7110, DX6.30, 7120, DX6.50, 7145, DX7.10	Bushing (Camshaft)
2244266V	1	7085, DX4.70, 7110, DX6.30, 7120, DX6.50, 7145, DX7.10	Actuator (Camshaft)

8000 SERIES

PISTONS			
74062632V	1	8030, 8050, 8070	Piston Assembly (Includes Ring Set, Pin, Retainer)
74062359V	1	8010	Piston Assembly (Includes Ring Set, Pin, Retainer)
LINERS			
74061938V	1	8010	Sleeve Kit
74037221V	1	8030, 8050, 8070	Sleeve Kit
RINGS			
74062157V	1	8010	Ring Set (Includes 3 Rings, Expander)
CONNECTING ROD BUSHINGS & HARDWARE			
74020049V	1	8010	Connecting Rod Bushing
CONNECTING ROD BEARINGS			
74036427V	1	8030, 8050, 8070	Bearing, Connecting Rod (.020")
74036426V	1	8030, 8050, 8070	Bearing, Connecting Rod (.010")
74007740V	4	8010	Bearing, Connecting Rod (.010")
74062337V	1	8030, 8050, 8070	Bearing Kit, Connecting Rod (STD)
74036429V	1	8030, 8050, 8070	Bearing Kit, Connecting Rod (.040")
74008168V	1	8010	Bearing Kit, Connecting Rod (.030")
74062516V	1	8030, 8050, 8070	Bearing Kit, Connecting Rod (.020")
74007741V	4	8010	Bearing Kit, Connecting Rod (.020")
74062515V	1	8030, 8050, 8070	Bearing Kit, Connecting Rod (.010")
74036261V	2	8030, 8050, 8070	Bearing, Connecting Rod (STD)
74007700V	4	8010	Bearing, Connecting Rod (STD)



74023378V

Liners, Pistons and Components

Part No.	Qty	MUO	Description
8000 SERIES CONTINUED			
CYLINDER HEAD HARDWARE			
74035388V	1	8010, 8030, 8050, 8070	Bolt, Cylinder Head (short)
74035389V	1	8010, 8030, 8050, 8070	Bolt, Cylinder Head (long)
VALVES			
74009936V	1	8010	Valve, Exhaust
74036609V	2	8030, 8050, 8070	Valve, Exhaust
74023378V	2	8010	Valve, Intake
74037135V	2	8030, 8050, 8070	Valve Intake
74035186V	6	8010, 8030, 8050, 8070	Valve Spring
74022595V	2	8010, 8030, 8050, 8070	Guide, Intake and Exhaust
ROCKER ARMS			
70277421V	1	8010, 8030, 8050, 8070	Rocker Arm Assembly
74025188V	4	8010, 8030, 8050, 8070	Rocker Arm Assembly
74028110V	2	8030, 8050, 8070	Rod, Push
74020185V	1	8010	Rod, Push
74026699V	1	8010, 8030, 8050, 8070	Valve, Lifter
74021454V	1	8010, 8030, 8050, 8070	Thrust Plate
ENGINE GASKETS			
74008074V	1	8010 Diesel	Gasket, Cylinder Head Cover
74035214V	1	8030, 8050, 8070	Gasket, Cylinder Head
74023471V	1	8010	Gasket, Cylinder Head
74008795V	1	8010	Gasket, Cylinder Head (End Cover)
70277087V	1	8010	Gasket Set, Intermediate
70277089V	1	8010	Gasket Set, Engine Overhaul
70277040V	1	8030, 8050, 8070	Gasket Set, Cylinder Head
74037120V	1	8030, 8050, 8070	Gasket Set, Complete Overhaul
74009450V	1	8010	Gasket Set, Cylinder. Head
70277414V	1	8030, 8050, 8070	Gasket Set, Cylinder. Head
SEALS			
74008103V	1	8010	Sleeve Kit, Oil Seal (Flywheel, Adapter Plate)
74029556V	1	8030, 8050, 8070	Sleeve Kit, Oil Seal (Flywheel, Adapter Plate)
74024562V	1	8010	Sleeve Kit, Oil Seal (Flywheel, Adapter Plate)
74062088V	1	8030, 8050, 8070	Sleeve Kit, Oil Seal (Flywheel, Adapter Plate)
74024561V	1	8010	Front Oil Seal, Crankshaft
74036340V	1	8030, 8050, 8070	Front Oil Seal, Crankshaft
70935121V	1	8030, 8050, 8550, 8070	O-Ring, Oil Tube
CRANKSHAFT			
74007696V	1	8010	Bearing, Rear, Upper (STD)
74007744V	1	8010	Bearing, Rear, Upper (.020")
74007743V	1	8010	Bearing, Rear, Upper (.010")
74007697V	1	8010	Bearing, Rear, Lower (STD)
74007754V	1	8010	Bearing, Rear, Lower (.020")
74007753V	1	8010	Bearing, Rear, Lower (.010")
74035010V	1	8030, 8050, 8070	Bearing, Rear & Center, Lower (STD)
74035053V	1	8030, 8050, 8070	Bearing, Rear & Center, Lower (.020")
74035052V	1	8030, 8050, 8070	Bearing, Rear & Center, Lower (.010")
74007695V	1	8010	Bearing, Front & Intermediate, Lower (STD)
74007760V	1	8010	Bearing, Front & Intermediate, Lower (.020")
74007759V	1	8010	Bearing, Front & Intermediate, Lower (.010")
74007694V	1	8010	Bearing, Front & Intermediate, Upper (STD)
70277389V	1	8030, 8050, 8070	Bearing, Front & Intermediate, Upper (.020")
74007746V	1	8010	Bearing, Front & Intermediate, Upper (.010")
74035008V	1	8030, 8050, 8070	Bearing, Front & Intermediate, Lower (STD)

Liners, Pistons and Components

Part No.	Qty	MUO	Description
CRANKSHAFT CONTINUED			
74035043V	1	8030, 8050, 8070	Bearing, Front & Intermediate, Lower (.020")
74035042V	1	8030, 8050, 8070	Bearing, Front & Intermediate, Lower (.010")
74006159V	1	8010	Bearing, Center, Upper (STD)
74006160V	1	8010	Bearing, Center, Lower (STD)
74006164V	1	8010	Bearing, Center, Lower (.020")
74006162V	1	8010	Bearing, Center, Lower (.010")
74006068V	1	8010	Bearing Kit, Main (.020")
74006067V	1	8010	Bearing Kit, Main (.010")
74062331V	1	8030, 8050, 8070	Bearing Kit, Main (STD)
74036914V	1	8050, 8070	Bearing Kit, Main (.020")
74036913V	1	8030, 8050, 8070	Bearing Kit, Main (.010")
70277386V	1	8030, 8050, 8070	Bearing, Rear & Center, Upper (STD)
CAMSHAFT			
74022519V	1	8010	Camshaft
74029000V	1	8030, 8050, 8070	Camshaft

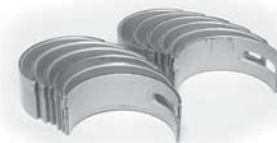

70277492V

Part No.	Qty	Description
4W220		
PISTONS		
74062632V	1	Piston Kit (Includes 1-Piston, 1-Set of Rings, 2-Retaining Rings, 1-Pin)
LINERS		
74037221V	1	Sleeve Kit
CONNECTING ROD BEARINGS		
74036261V	2	Bearing, Connecting Rod (STD)
74062337V	1	Bearing Kit, Connecting Rod (STD)
74036429V	1	Bearing Kit, Connecting Rod (.040")
74062516V	1	Bearing Kit, Connecting Rod (.020")
74062515V	1	Bearing Kit, Connecting Rod (.010")
74036427V	1	Bearing, Connecting Rod (.020")
74036426V	1	Bearing, Connecting Rod (.010")
CYLINDER HEAD HARDWARE		
74035388V	1	Capscrew, Cylinder Head (short)
74035389V	1	Capscrew, Cylinder Head (long)
VALVES		
74036609V	2	Valve, Exhaust
74037135V	2	Valve Intake
74022595V	2	Guide, Intake and Exhaust
74035186V	6	Valve Spring
74026699V	1	Valve, Lifter
ROCKER ARMS		
70277421V	1	Rocker Arm Assembly
74025188V	4	Rocker Arm Assembly
74028110V	2	Rod, Push
74021454V	1	Plate, Thrust
70225672V	1	Nut, Valve Lash Adjustment Screw
ENGINE GASKETS		
74035214V	1	Gasket, Cylinder Head
70277040V	1	Gasket Set, Cylinder Head
74037120V	1	Gasket Set, Complete Overhaul
70277414V	1	Gasket Set, Cylinder Head



74007696V

Part No.	Qty	Description
SEALS		
74029556V	1	Wear Sleeve, Oil Seal (Flywheel & Adapter Plate)
74062088V	1	Wear Sleeve, Oil Seal (Flywheel & Adapter Plate)
74036340V	1	Seal, Oil Crankshaft
70935121V	1	O-Ring, Oil Tube
CRANKSHAFT MAIN BEARINGS		
70277386V	1	Bearing, Rear & Center, Upper (STD)
70277389V	1	Bearing, Front & Intermediate, Upper (.020")
74035010V	1	Bearing, Rear & Center, Lower (STD)
74035053V	1	Bearing, Rear & Center, Lower (.020")
74035052V	1	Bearing, Rear & Center, Lower (.010")
74035043V	1	Bearing, Front & Intermediate, Lower (.020")
74035042V	1	Bearing, Front & Intermediate, Lower (.010")
74035008V	1	Bearing, Front & Intermediate, Lower (STD)
74062331V	1	Bearing Kit, Main (STD)
74036914V	1	Bearing Kit, Main (.020")
74036913V	1	Bearing Kit, Main (.010")
COMPONENTS		
70905127V	1	Key, Woodruff
CAMSHAFT		
74029000V	1	Camshaft

Liners, Pistons and Components

Part No.	Qty	MUO	Description
----------	-----	-----	-------------

DEUTZ-ALLIS 6200 SERIES / DEUTZ-FAHR 3.00 SERIES

PISTONS

4157748V	1	6250VF, DX3.30VF, 6260FV, DX3.50VF, 6275F, 6260-Star Cab, DX3.50-Star Cab, 6260-Vario Cab, 6275-Star Cab, DX3.90-Star Cab, 6275-Vario Cab, DX3.90-Vario Cab	Piston, (102mm) (4.0157")
4231966V	1	6240, 6250, DX3.30, 6265, DX3.70-Vario Cab, 6265, DX3.30-Star Cab, 6250, DX3.30VF, 6260, DX3.50FV, 6275F	Piston Assembly (STD)
4231968V	1	6240, 6250, DX3.30, 6265, DX3.70-Vario Cab, 6265, DX3.30-Star Cab, 6250, DX3.30VF, 6260, DX3.50FV, 6275F	Piston Assembly
2928137V	1	6260, DX3.50, 6260, DX3.50-Vario Cab	Piston, Rings, Liner Kit

LINERS

4231513V	1	6250VF, DX3.30VF, 6260FV, DX3.50VF, 6275F, 6260, DX3.50, 6275, DX3.90-Star Cab, 6260, 6275, DX3.90-Star Cab	Liner, Cylinder
4231497V	1	6240, 6250, DX3.30, 6265, DX3.70-Vario Cab, 6250VF, DX3.30VF, 6260FV, DX3.50FV, 6275F, 6265, DX3.70-Star Cab	Liner, Cylinder

RINGS

2230216V	1	6240-Vario Cab, 6250-Vario Cab, DX3.30-Vario Cab, 6250VF, DX3.30VF, 6260FV, DX3.50VF, 6275F, 6260-Star Cab, DX3.50-Star Cab, 6260-Vario Cab, 6265-Star Cab, DX3.70-Star Cab, 6265-Vario Cab, DX3.70-Vario Cab, 6275-Star Cab, DX3.90-Star Cab, 6275-Vario Cab, DX3.90-Vario Cab	Ring, Intermediate
2233077V	1	6240-Vario Cab, 6250-Vario Cab, DX3.30-Vario Cab, 6265-Star Cab, DX3.70-Star Cab, 6265-Vario Cab, DX3.70-Vario Cab	Set, 2nd Over (100.50mm) (4 Rings)
4152185V	1	6250VF, DX3.30VF, 6260FV, DX3.50VF, 6275F, 6260-Star Cab, DX3.50-Star Cab, 6260-Vario Cab, 6275-Star Cab, DX3.90-Star Cab, 6275-Vario Cab, DX3.90-Vario Cab	Ring Set (102mm) (4.0157")
4156574V	1	6240-Vario Cab, 6250-Vario Cab, DX3.30-Vario Cab, 6250VF, DX3.30VF, 6260FV, DX3.50VF, 6275F Only, 6265-Star Cab, DX3.70-Star Cab, 6265 -Vario Cab, DX3.70-Vario Cab	Ring Set (100.50mm)



74007741V

ENGINE

Liners, Pistons and Components

Part No.	Qty	MUO	Description
RINGS CONTINUED			
4156566V	1	6240-Vario Cab, 6250-Vario Cab, DX.30-Vario Cab, 6250VF, DX3.30VF, 6260FV, DX3.50VF, 6275F, 6265-Star Cab, DX3.70-Star Cab, 6265-Vario Cab, DX3.70-Vario Cab	Ring Set (100mm) (STD)
2233074V	1	6240-Vario Cab, 6250-Vario Cab, DX3.30-Vario Cab, 6265-Star Cab, DX3.70 Star Cab, 6265-Vario Cab, DX3.70-Vario Cab	Ring Set (100mm) (4 Rings)
CONNECTING ROD BUSHINGS & HARDWARE			
3371612V	1	6240-Vario Cab, 6250-Vario Cab, DX3.30-Vario Cab, 6250VF, DX3.30VF, 6260FV, DX3.50VF, 6275F, 6260-Star Cab, DX3.50-Star Cab, 6260-Vario Cab, 6265-Star Cab, DX3.70-Star Cab, 6265-Vario Cab, DX3.70-Vario Cab, 6275-Star Cab, DX3.90-Star Cab, 6275-Vario Cab, DX3.90-Vario Cab	Connecting Rod Bushing
4157075V	1	6240-Vario Cab, 6250-Vario Cab, DX3.30-Vario Cab, 6250VF, DX3.30VF, 6260FV, DX3.50VF, 6275F, 6260-Star Cab, DX3.50-Star Cab, 6260-Vario Cab, 6265-Star Cab, DX3.70-Star Cab, 6265-Vario Cab, DX3.70-Vario Cab, 6275-Star Cab, DX3.90-Star Cab, 6275-Vario Cab, DX3.90-Vario Cab	Connecting Rod Bolt
CONNECTING ROD BEARINGS			
2137750V	1	6240-Vario Cab, 6250-Vario Cab, DX3.30-Vario Cab, 6250VF, DX3.30VF, 6260 FV, DX3.50VF, 6275F Only, 6260-Star Cab, DX3.50-Star Cab, 6260-Vario Cab, 6265-Star Cab, DX3.70-Star Cab, 6265-Vario Cab, DX3.70-Vario Cab, 6275-Star Cab, DX3.90-Star Cab, 6275-Vario Cab, DX3.90-Vario Cab	Connecting Rod (60mm) Bearing
4231896V	1	6240, 6260, 6265, DX3.70, 6275, DX3.90-Vario Cab, 6260, DX3.50, 6265, DX3.70, 6275, DX3.90, 6250, DX3.30VF, 6260, DX3.30FV, 6275F	Connecting Rod (59.75mm) Bearing
CYLINDER HEAD HARDWARE			
2101681V	1	6240-Vario Cab, 6250-Vario Cab, DX3.30-Vario Cab, 6250VF, DX3.30VF, 6260 FV, DX3.50VF, 6275F, 6260-Star Cab, DX3.50-Star Cab, 6260-Vario Cab, 6265-Star Cab, DX3.70-Star Cab, 6265 -Vario Cab, DX3.70-Vario Cab, 6275-Star Cab, DX3.90-Star Cab, 6275-Vario Cab, DX3.90-Vario Cab	Cylinder Head Bolt



74062157V

Part No.	Qty	MUO	Description
----------	-----	-----	-------------

DEUTZ-ALLIS 6200 SERIES / DEUTZ-FAHR 3.00 SERIES

CYLINDER HEAD HARDWARE CONTINUED

3371666V	1	6240-Vario Cab, 6250-Vario Cab, DX3.30-Vario Cab, 6250VF, DX3.30VF, 6260FV, DX3.50VF, 6275F, 6260-Star Cab, DX3.50-Star Cab, 6260-Vario Cab, 6265-Star Cab, DX3.70-Star Cab, 6265-VarioCab, DX3.70-Vario Cab, 6275-Star Cab, DX3.90-Star Cab, 6275-Vario Cab, DX3.90-Vario Cab	Cylinder Head Washer
1216307V	1	6240-Vario Cab, 6250-Vario Cab, DX3.30-Vario Cab, 6250VF, DX3.30VF, 6260FV, DX3.50VF, 6275F, 6260-Star Cab, DX3.50-Star Cab, 6260-Vario Cab, 6265-Star Cab, DX3.70-Star Cab, 6265-Vario Cab, DX3.70-Vario Cab, 6275-Star Cab, DX3.90-Star Cab, 6275-Vario Cab, DX3.90-Vario Cab	Cylinder Head Cover Washer

VALVES

4159139V	1	6240-Vario Cab, 6250-Vario Cab, DX3.30-Vario Cab, 6250VF, DX3.30VF, 6260FV, DX3.50VF, 6275F, 6260-Star Cab, DX3.50-Star Cab, 6260-Vario Cab, 6265-Star Cab, DX3.70-Star Cab, 6265-Vario Cab, DX3.70-Vario Cab, 6275-Star Cab, DX3.90-Star Cab, 6275-Vario Cab, DX3.90-Vario Cab	Exhaust Valve
4153697V	1	6240-Vario Cab, 6250-Vario Cab, DX3.30-Vario Cab, 6250VF, DX3.30VF, 6260FV, DX3.50VF, 6275F, 6260-Star Cab, DX3.50-Star Cab, 6260-Vario Cab, 6265-Star Cab, DX3.70-Star Cab, 6265-Vario Cab, DX3.70-Vario Cab, 6275-Star Cab, DX3.90-Star Cab, 6275-Vario Cab, DX3.90-Vario Cab	Exhaust Valve
2108102V	1	6240-Vario Cab, 6250-Vario Cab, DX3.30-Vario Cab, 6250VF, DX3.30VF, 6260FV, DX3.50VF, 6275F, 6260-Star Cab, DX3.50-Star Cab, 6260-Vario Cab, 6265-Star Cab, DX3.70-Star Cab, 6265-Vario Cab, DX3.70-Vario Cab, 6275-Star Cab, DX3.90-Star Cab, 6275-Vario Cab, DX3.90-Vario Cab	Exhaust Valve

ENGINE

Liners, Pistons and Components

Part No.	Qty	MUO	Description
VALVES CONTINUED			
4153631V	1	6240-Vario Cab, 6250-Vario Cab, DX3.30-Vario Cab, 6250VF, DX3.30VF, 6260FV, DX3.50VF, 6275F, 6260-Star Cab, DX3.50-Star Cab, 6260-Vario Cab, 6265-Star Cab, DX3.70-Star Cab, 6265-Vario Cab, DX3.70-Vario Cab, 6275-Star Cab, DX3.90-Star Cab, 6275-Vario Cab, DX3.90-Vario Cab	Valve, Intake
4159136V	1	6240-Vario Cab, 6250-Vario Cab, DX3.30-Vario Cab, 6250VF, DX3.30VF, 6260FV, DX3.50VF, 6275F, 6260-Star Cab, DX3.50-Star Cab, 6260-Vario Cab, 6265-Star Cab, DX3.70-Star Cab, 6265-Vario Cab, DX3.70-Vario Cab, 6275-Star Cab, DX3.90-Star Cab, 6275-Vario Cab, DX3.90-Vario Cab	Valve, Intake
2137302V	1	6240-Vario Cab, 6250-Vario Cab, DX3.30-Vario Cab, 6250VF, DX3.30VF, 6260FV, DX3.50VF, 6275F, 6260-Star Cab, DX3.50 Star Cab, 6260-Vario Cab, 6265-Star Cab, DX3.70-Star Cab, 6265-Vario Cab, DX3.70-Vario Cab, 6275-Star Cab, DX3.90-Star Cab, 6275-Vario Cab, DX3.90-Vario Cab	Valve Seat (STD) (45.66mm)
2137306V	1	6240-Vario Cab, 6250-Vario Cab, DX3.30-Vario Cab, 6250VF, DX3.30VF, 6260FV, DX3.50VF, 6275F, 6260-Star Cab, DX3.50-Star Cab, 6260-Vario Cab, 6265-Star Cab, DX3.70-Star Cab, 6265-Vario Cab, DX3.70-Vario Cab, 6275-Star Cab, DX3.90-Star Cab, 6275-Vario Cab, DX3.90 Vario Cab	Valve Seat (40.16mm)
2232840V	1	6240-Vario Cab, 6250-Vario Cab, DX3.30-Vario Cab, 6250VF, DX3.30VF, 6260FV, DX3.50VF, 6275F, 6260-Star Cab, DX3.50-Star Cab, 6260-Vario Cab, 6265-Star Cab, DX3.70-Star Cab, 6265-Vario Cab, DX3.70-Vario Cab, 6275-StarCab, DX3.90-Star Cab, 6275-Vario Cab, DX3.90-Vario Cab	Valve Seal
2232528V	1	6240-Vario Cab, 6250-Vario Cab, DX3.30-Vario Cab, 6250VF, DX3.30VF, 6260FV, DX3.50VF, 6275F, 6260-Star Cab, DX3.50-Star Cab, 6260-Vario Cab, 6265-Star Cab, DX3.70Star Cab, 6265-Vario Cab, DX3.70-Vario Cab, 6275-Star Cab, DX3.90-Star Cab, 6275-Vario Cab, DX3.90-Vario Cab	Valve Guide (15mm)

For complete overhaul kits, see pages 95-99

ENGINE

Part No.	Qty	MUO	Description
DEUTZ-ALLIS 6200 SERIES / DEUTZ-FAHR 3.00 SERIES			
VALVES CONTINUED			
3369305V	1	6240-Vario Cab, 6250-Vario Cab, DX3.30-Vario Cab, 6250VF, DX3.30VF, 6260FV, DX3.50VF, 6275F, 6260-Star Cab, DX3.50-Star Cab, 6260-Vario Cab, 6265-StarCab, DX3.70-Star Cab, 6265-Vario Cab, DX3.70-Vario Cab, 6275-Star Cab, DX3.90-Star Cab, 6275-Vario Cab, DX3.90-Vario Cab	Valve Spring
1168817V	1	6240, 6250, DX3.30, 6265-Vario Cab, 6250VF, DX3.30VF, 6260FV, DX3.50VF, 6275F, 6260-Star Cab, DX3.50-Star Cab, 6260-Vario Cab, 6265-Star Cab, DX3.70-Star Cab, 6265-Vario Cab, DX3.70-Vario Cab, 6275-Star Cab, DX3.90-Star Cab, 6275-Vario Cab, DX3.90-Vario Cab	Collet, Taper
3371885V	1	6240-Vario Cab, 6250-Vario Cab, DX3.30-Vario Cab, 6250VF, DX3.30VF, 6260FV, DX3.50VF, 6275F, 6260-Star Cab, DX3.50 Star Cab, 6260-Vario Cab, 6265-Star Cab, DX3.70-Star Cab, 6265-Vario Cab, DX3.70-Vario Cab, 6275-Star Cab, DX3.90-Star Cab, 6275-Vario Cab, DX3.90-Vario Cab	Tappet, Valve
2237661V	1	6240-Vario Cab, 6250-Vario Cab, DX3.30-Vario Cab, 6250VF, DX3.30VF, 6260FV, DX3.50VF, 6275F, 6260-Star Cab, DX3.50-Star Cab, 6260-Vario Cab, 6265-Star Cab, DX3.70-Star Cab, 6265-Vario Cab, DX3.70-Vario Cab, 6275-Star Cab, DX3.90 Star Cab, 6275-Vario Cab, DX3.90-Vario Cab	Bushing, Valve Mechanism
2237665V	1	6240-Vario Cab, 6250-Vario Cab, DX3.30-Vario Cab, 6250VF, DX3.30VF, 6260FV, DX3.50VF, 6275F, 6260-Star Cab, DX3.50-Star Cab, 6260-Vario Cab, 6265-Star Cab, DX3.70-Star Cab, 6265-Vario Cab, DX3.70-Vario Cab, 6275-Star Cab, DX3.90-Star Cab, 6275-Vario Cab, DX3.90-Vario Cab	Bushing, Shaft Mechanism

Liners, Pistons and Components

Part No.	Qty	MUO	Description
CYLINDER HEAD ASSEMBLIES			
4230614V	1	6240-Vario Cab, 6250VF, DX3.30VF, 6260FV, DX3.50VF, 6275F	Cylinder Head
4230613V	1	6250-Vario Cab, DX3.30-Vario Cab, 6260-Star Cab, DX3.50-Star Cab, 6260-Vario Cab, 6265-Star Cab, DX3.70-Star Cab, 6265-Vario Cab, DX3.70-Vario Cab, 6275-Star Cab, DX3.90-Star Cab, 6275-Vario Cab, DX3.90-Vario Cab	Cylinder Head
CYLINDER SHIMS			
4231433V	1	6240, 6260, 6265, DX3.70, 6275, DX3.90-Vario Cab, 6260, DX3.50, 6265, DX3.70, 6275, DX3.90, 6250, DX3.30VF, 6260, DX3.30FV, 6275F	Shim (0.8mm)
4231432V	1	6240, 6260, 6265, DX3.70, 6275, DX3.90-Vario Cab, 6260, DX3.50, 6265, DX3.70, 6275, DX3.90, 6250, DX3.30VF, 6260, DX3.30FV, 6275F	Shim (0.05mm)
2137256V	1	6240-Vario Cab, 6250-Vario Cab, DX3.30-Vario Cab, 6250VF, DX3.30VF, 6260FV, DX3.50VF, 6275F, 6260-Star Cab, DX3.50-Star Cab, 6260-Vario Cab, 6265-StarCab, DX3.70-Star Cab, 6265-Vario Cab, DX3.70-Vario Cab, 6275-Star Cab, DX3.90-Star Cab, 6275-Vario Cab, DX3.90-Vario Cab	Shim (0.02mm)
ENGINE GASKETS			
3371692V	5	6240-Vario Cab, 6250-Vario Cab, DX3.30-Vario Cab, 6250VF, DX3.30VF, 6260FV, DX3.50VF, 6275F, 6260-Star Cab, DX3.50-Star Cab, 6260-Vario Cab, 6265-Star Cab, DX3.70-Star Cab, 6265-Vario Cab, DX3.70-Vario Cab, 6275-Star Cab, DX3.90-Star Cab, 6275-Vario Cab, DX3.90-Vario Cab	Gasket, Cylinder Head Cover
2928994V	1	6240-Vario Cab, 6250-Vario Cab, DX3.30-Vario Cab, 6250VF, DX3.30VF, 6260FV, DX3.50VF, 6275F, 6260-Star Cab, DX3.50-Star Cab, 6260-Vario Cab, 6265-Star Cab, DX3.70-Star Cab, 6265-Vario Cab, DX3.70-Vario Cab, 6275-Star Cab, DX3.90-Star Cab, 6275-Vario Cab, DX3.90-Vario Cab	Gasket Set, Single Cylinder
2929656V	1	6240-Vario Cab, 6250-Vario Cab, DX3.30-Vario Cab, 6250VF, DX3.30VF, 6260FV, DX3.50VF, 6275F	Gasket Set, Complete Overhaul

For complete overhaul kits, see pages 95-99

Liners, Pistons and Components



74007740V

Part No.	Qty	MUO	Description
----------	-----	-----	-------------

DEUTZ-ALLIS 6200 SERIES / DEUTZ-FAHR 3.00 SERIES

ENGINE GASKETS CONTINUED

2929649V	1	6265-Star Cab, DX3.70-Star Cab	Gasket Set, Complete Overhaul
----------	---	--------------------------------	-------------------------------

2929646V	1	6250VF, DX3.30VF, 6260FV, DX3.50VF, 6275F, 6275-Star Cab, DX3.90-Star Cab, 6275-Vario Cab, DX3.90-Vario Cab	Gasket Set, Complete Overhaul
----------	---	--	-------------------------------

2911578V	1	6250VF, DX3.30VF, 6260 FV, DX3.50VF, 6275F, 6260-Star Cab, DX3.50-Star Cab, 6260-Vario Cab	Gasket Set, Complete Overhaul
----------	---	---	-------------------------------

3362337V	1	6250-Vario Cab, DX3.30-Vario Cab, 6250VF, DX3.30VF, 6260 FV, DX3.50VF, 6275F, 6260-Star Cab, DX3.50-Star Cab, 6260-Vario Cab, 6265-Star Cab, DX3.70-Star Cab, 6265-Vario Cab, DX3.70-Vario Cab, 6275-Star Cab, DX3.90 Star Cab, DX3.90-Star Cab, 6275-Vario Cab, DX3.90-Vario Cab	Gasket, Crank Case Cover Seals
----------	---	---	--------------------------------

4230392V	1	6240-Vario Cab, 6250-Vario Cab, DX3.30-Vario Cab, 6250VF, DX3.30VF, 6260FV, DX3.50VF, 6275F, 6260-Star Cab, DX3.50-Star Cab, 6260-Vario Cab, 6265-Star Cab, DX3.70-Star Cab, 6265-Vario Cab, DX3.70-Vario Cab, 6275-Star Cab, DX3.90-Star Cab, 6275-Vario Cab, DX3.90-Vario Cab	Seal, Front Crank Case
----------	---	--	------------------------

4152348V	1	6240-Vario Cab, 6250-Vario Cab, DX3.30-Vario Cab, 6250VF, DX3.30VF, 6260FV, DX3.50VF, 6275F, 6260-Star Cab, DX3.50-Star Cab, 6260-Vario Cab, 6265-Star Cab, DX3.70-Star Cab, 6265-Vario Cab, DX3.70-Vario Cab, 6275-Star Cab, DX3.90-Star Cab, 6275-Vario Cab, DX3.90-Vario Cab	Seal, Front Crank Case
----------	---	--	------------------------

MAIN BEARINGS

3362379V	1	6240-Vario Cab, 6250-Vario Cab, DX3.30-Vario Cab, 6250VF, DX3.30VF, 6260FV, DX3.50VF, 6275F, 6260-Star Cab, DX3.50-Star Cab, 6260-Vario Cab, 6265-Star Cab, DX3.70-Star Cab, 6265-Vario Cab, DX3.70-Vario Cab, 6275-Star Cab, DX3.90-Star Cab, 6275-Vario Cab, DX3.90-Vario Cab	Bearing, Main (70mm) (STD)
----------	---	--	----------------------------

3362380V	1	6240-Vario Cab, 6250-Vario Cab, DX3.30-Vario Cab, 6250VF, DX3.30VF, 6260FV, DX3.50VF, 6275F, 6260-Star Cab, DX3.50-Star Cab, 6260-Vario Cab, 6265-Star Cab, DX3.70-Star Cab, 6265-Vario Cab, DX3.70-Vario Cab, 6275-Star Cab, DX3.90-Star Cab, 6275-Vario Cab, DX3.90-Vario Cab	Bearing, Main (69.75mm)
----------	---	--	-------------------------

Liners, Pistons and Components

Part No.	Qty	MUO	Description
MAIN BEARINGS CONTINUED			
3362381V	1	6240-Vario Cab, 6250-Vario Cab, DX3.30-Vario Cab, 6250VF, DX3.30VF, 6260FV, DX3.50VF, 6275F, 6260-Star Cab, DX3.50-Star Cab, 6260-Vario Cab, 6265-Star Cab, DX3.70-Star Cab, 6265-Vario Cab, DX3.70-Vario Cab, 6275-Star Cab, DX3.90-Star Cab, 6275-Vario Cab, DX3.90-Vario Cab	Bearing, Main (69.50mm)
RING STOPS			
2230183V	1	6240-Vario Cab, 6250-Vario Cab, DX3.30-Vario Cab, 6250VF, DX3.30VF, 6260 FV, DX3.50VF, 6275F, 6260-Star Cab, DX3.50-Star Cab, 6260-Vario Cab, 6275-Star Cab, DX3.90-Star Cab, 6275-Vario Cab, DX3.90-Vario Cab	Ring, Stop (3.50mm)
2230178V	1	6240-Vario Cab, 6250-Vario Cab, DX3.30-Vario Cab, 6265-Star Cab, DX3.70-Star Cab, 6265-Vario Cab, DX3.70-Vario Cab	Ring, Stop (3.50mm)
2230173V	1	6240-Vario Cab, 6250-Vario Cab, DX3.30-Vario Cab, 6250VF, DX3.30VF, 6260 FV, DX3.50VF, 6275F, 6260-Star Cab, DX3.50-Star Cab, 6260-Vario Cab, 6275-Star Cab, DX3.90-Star Cab, 6275-Vario Cab, DX3.90-Vario Cab	Ring, Stop (3.50mm)
2230167V	1	6240-Vario Cab, 6250-Vario Cab, DX3.30-Vario Cab, 6265-Star Cab, DX3.70-Star Cab, 6265-Vario Cab, DX3.70-Vario Cab	Ring, Stop (3.50mm)
2230182V	1	6240-Vario Cab, 6250-Vario Cab, DX3.30-Vario Cab, 6250VF, DX3.30VF, 6260FV, DX3.50VF, 6275F, 6260-Star Cab, DX3.50-Star Cab, 6260-Vario Cab, 6275-Star Cab, DX3.90-Star Cab, 6275-Vario Cab, DX3.90-Vario Cab	Ring, Stop (3.25mm)
2230177V	1	6240-Vario Cab, 6250-Vario Cab, DX3.30-Vario Cab, 6265-Star Cab, DX3.70-Star Cab, 6265-Vario Cab, DX3.70-Vario Cab	Ring, Stop (3.25mm)
2230172V	1	6240-Vario Cab, 6250-Vario Cab, DX3.30-Vario Cab, 6250VF, DX3.30VF, 6260 FV, DX3.50VF, 6275F, 6260-Star Cab, DX3.50-Star Cab, 6260-Vario Cab, 6275-Star Cab, DX3.90-Star Cab, 6275-Vario Cab, DX3.90-Vario Cab	Ring, Stop (3.25mm)
2230166V	1	6240-Vario Cab, 6250-Vario Cab, DX3.30-Vario Cab, 6265-Star Cab, DX3.70-Star Cab, 6265-Vario Cab, DX3.70-Vario Cab	Ring, Stop (3.25mm)
2230176V	1	6240-Vario Cab, 6250-Vario Cab, DX3.30-Vario Cab, 6265-Star Cab, DX3.70-Star Cab, 6265-Vario Cab, DX3.70-Vario Cab	Ring, Stop (3mm) (STD)

For complete overhaul kits, see pages 95-99

Liners, Pistons and Components

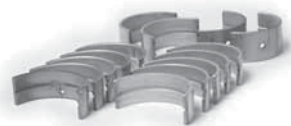

74062331V



731150V1



739043V1

Part No.	Qty	MUO	Description
----------	-----	-----	-------------

DEUTZ-ALLIS 6200 SERIES / DEUTZ-FAHR 3.00 SERIES

RING STOPS CONTINUED

2230181V	1	6240-Vario Cab, 6250-Vario Cab, DX3.30-Vario Cab (Prior to Eng. SN 5160390), 6250VF, DX3.30VF, 6260 FV, DX3.50VF, 6275F, 6260, DX3.50-Star Cab, 6260-Vario Cab, 6275, DX3.90-Star Cab, 6275, DX3.90-Vario Cab	Ring, Stop (3mm)
----------	---	--	------------------

2230170V	1	6240-Vario Cab, 6250-Vario Cab, DX3.30-Vario Cab, 6260-Star Cab, DX3.50-Star Cab, 6260-Vario Cab, 6275-Star Cab, DX3.90-Star Cab, 6275-Vario Cab, DX3.90-Vario Cab	Ring, Stop (3mm)
----------	---	--	------------------

TIMING

2139737V	1	6240-Vario Cab, 6250-Vario Cab, DX3.30-Vario Cab, 6250 VF, DX3.30VF, 6260 FV, DX3.50VF, 6275F, 6260-Star Cab, DX3.50-Star Cab, 6260-Vario Cab, 6265-Star Cab, DX3.70-Star Cab, 6265-Vario Cab, DX3.70-Vario Cab, 6275-Star Cab, DX3.90-Star Cab, 6275-Vario Cab, DX3.90-Vario Cab	Bushing (Camshaft)
----------	---	---	--------------------

2131081V	1	6240-Vario Cab, 6250-Vario Cab, DX3.30-Vario Cab, 6250VF, DX3.30VF, 6260FV, DX3.50VF, 6275F, 6260-Star Cab, DX3.50-Star Cab, 6260-Vario Cab, 6265-Star Cab, DX3.70-Star Cab, 6265-Vario Cab, DX3.70-Vario Cab, 6275-Star Cab, DX3.90-Star Cab, 6275-Vario Cab, DX3.90-Vario Cab	Gear, Ring (Flywheel)
----------	---	---	-----------------------

Overhaul Kits

Complete Kit Includes: Sleeves, pistons, piston rings, gaskets, thrust washers, washers, seals, bushings, valves, springs, guides, valve locks

KIT ORDERING GUIDE

1. Locate Tractor or Combine Model
2. Verify Engine / Serial Number Information
3. Locate additional options required for rebuild in the section of this Catalog
 - a. Upper Gasket Set
 - b. Main Bearing Set
 - c. Rod Bearing Set
 - d. Thrust Washers
 - e. Oil Pump

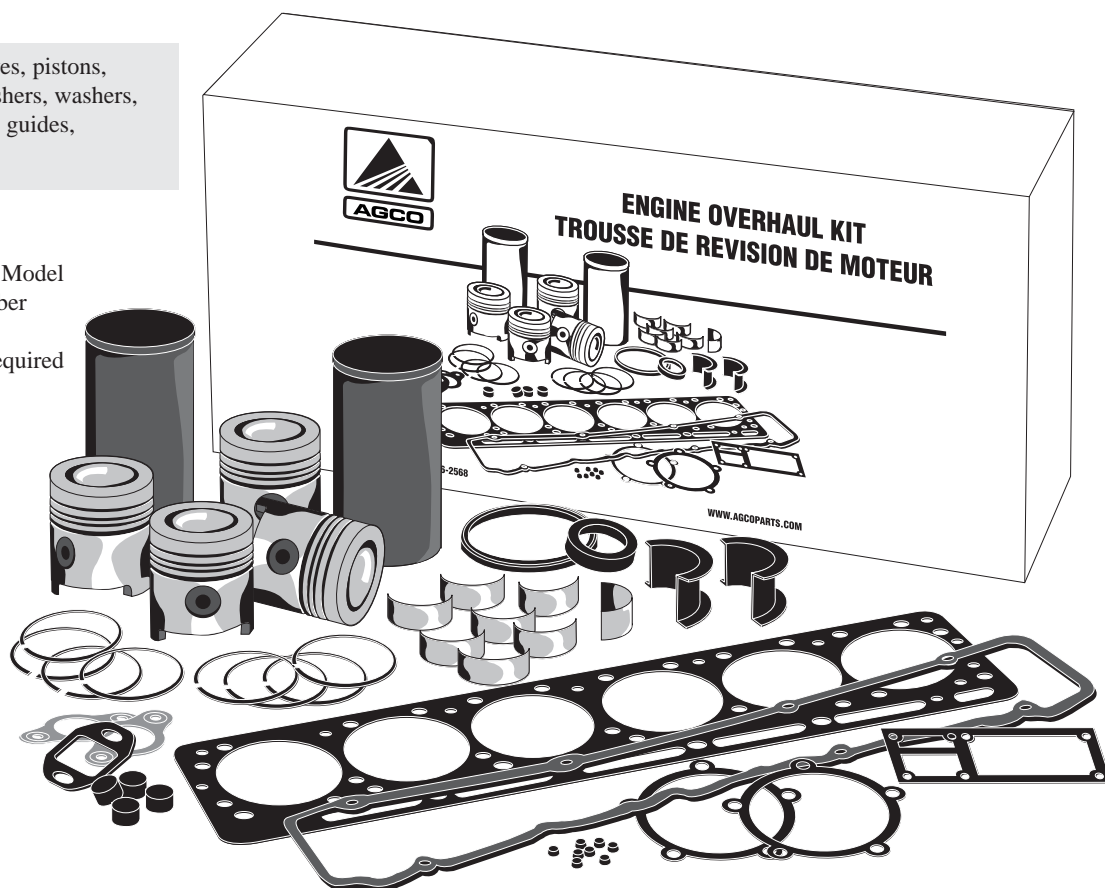

ENGINE

MUO	Engine Description	Part No.
ALLIS-CHALMERS		
160 DIESEL, 6040	AD3.152	839236M91

Parts in Kit	Qty
Washer	10
Washer, (Fuel Flow Meter)	10
Inj. Olive, 3/16"	10
Inj. Olive, 1/4"	10
Valve Spring	6
Cotter, Valve	12
Valve Guide	6
Intake Valve	3
Thrust Washer	2
Thrust Washer	2
Rear Oil Seal	2
Exhaust Valve	3
Piston Liner	3
Connecting Rod Bushing	3
Gasket, Oil Seal Housing	1
Gasket, Oil Pan (Sides)	1
Piston Assembly	3
Spacer	1
Gasket Set, Lower Overhaul	1
Gasket Set, Upper Overhaul	1
Seal	1
Ring Set	3
Oil Seal	1
Oil Seal	1

MUO	Engine Description	Part No.
170	Perkins 4.236	79019024
	Gasket Set:	
	For build list LM31326	4224370M1
	For all other build lists	4224369M91

Parts in Kit	Qty
Washer, Fuel Injection	8
Oil Seal	1
Valve Seal	8
Gasket Set, Upper Overhaul	1
Washer, Seal	2
Inj. Olive	2
Inj. Olive	8
Piston Assembly	4
Valve Spring	8
Seal, Housing	2
Lock, Spring Retainer	8
Main Bearing Set	1
Intake Valve	4
Ring Set	4
Thrust Washer	2
Thrust Washer	2
Exhaust Valve	4
Piston Liner	4

Overhaul Kits

MUO	Engine Description	Part No.
ALLIS-CHALMERS CONTINUED		
175	Perkins 4.236	79019023
	Gasket Set:	
	For build list LM31326	4224370M1
	For all other build lists	4224369M91
	Parts in Kit	Qty
	Front Oil Seal	1
	Rear Oil Seal	1
	Valve Seal	8
	Gasket Set, Upper Overhaul	1
	Washer, Filter Head	2
	Inj. Olive	2
	Inj. Olive	8
	Outer Valve Spring	8
	Inner Valve Spring	8
	Lock, Spring Retainer	8
	Main Bearing Set	1
	Piston Liner	4
	Intake Valve	4
	Piston Assembly	4
	Ring Set	4
	Thrust Washer	2
	Thrust Washer	2
	Exhaust Valve	4
180, 190, 190XT	D2800	79017717
	Parts in Kit	Qty
	Piston Kit	6
	Gasket, Fuel Injection Nozzle (Dust Shield & Nozzle Gasket)	1
	Sleeve Kit	6
	Gasket Set, Intermediate	1
	Gasket, Oil Pan	1
	Rear Oil Seal	1
	Wear Kit, Sleeve	1
	Front Oil Seal	1
	Valve Kit	1
200, 7000	D2900	79017718
	Parts in Kit	Qty
	Piston Kit	6
	Gasket, Fuel Injection Nozzle (Dust Shield & Nozzle Gasket)	1
	Sleeve Kit	6
	Gasket Set, Intermediate	1
	Gasket, Oil Pan	1
	Rear Oil Seal	1
	Wear Kit, Sleeve	1
	Front Oil Seal	1
	Valve Kit	1
210, 220, 7030, 7040, 7045, 7050, 7060	3500	79017720

MUO	Engine Description	Part No.
7080	D3500	79017720
	Parts in Kit	Qty
	Piston Kit	6
	Sleeve Kit	6
	Gasket Set, Cylinder Head	1
	Gasket Set, Intermediate	1
	Gasket, Oil Pan	1
	Front Oil Seal	1
	Rear Oil Seal	1
	Wear Kit, Sleeve	1
	Valve Kit	1
6240VC/3.10, 6250VC/3.30	F3L912	79017823
	Parts in Kit	Qty
	Lock, Spring Retainer	12
	Rod Bearing	3
	Ring Stop	1
	Ring Stop	1
	Ring, Intermediate	3
	Valve Guide	6
	Bushing, Rocker Arm	6
	Bushing Shaft (Rocker Arms)	6
	Gasket Set, Complete Overhaul	1
	Piston Assembly	3
	Piston Liner	4
	Connecting Rod Bushing	3
	Rear Oil Seal	1
	Front Oil Seal	1
	Intake Valve	3
	Exhaust Valve	3
	Lock, Spring Retainer	12
	Cap, Spring	6
7010, 7020	D2900MKII	79017718
8010	649I	79017718
	Parts in Kit	Qty
	Piston Kit	6
	Gasket Set, Cylinder Head	1
	Sleeve Kit	6
	Gasket Set, Intermediate	1
	Gasket, Oil Pan	1
	Wear Kit, Sleeve	1
	Rear Oil Seal	1
	Front Oil Seal	1
	Valve Kit	1
7085	BF4L913	79017954
	Parts in Kit	Qty
	Lock, Spring Retainer	16
	Ring, Intermediate	4
	Bushing, Rocker Arm	8
	Piston/Cylinder Kit	4
	Gasket Set, Complete Overhaul	1
	Gasket, Crank Case Front Cover	1
	Gasket, Oil Pan	1
	Front Oil Seal	1
	Intake Valve	4

ENGINE

Overhaul Kits

MUO	Engine Description	Part No.
7085 CONTINUED		
	Exhaust Valve	4
	Rear Oil Seal	1
	Valve Guide	8
	Gasket, Crankcase	1
	Cap, Spring	8
7110	F6L913	79018568
	Parts in Kit	Qty
	Main Bearing	7
	Bearing	6
	Piston Kit	6
	Lock, Spring Retainer	24
	Cap, Spring	12
	Valve Guide	12
	Gasket Set (Single Cylinder)	6
	Gasket Set	1
	Bushing, Rocker Arm	12
	Seal, Shaft	1
	Oil Seal	1
	Ring Set	6
	Intake Valve	6
	Connecting Rod Bushing	6
	Exhaust Valve	6
7120/DX6.50	BF6L913	79017827
	Parts in Kit	Qty
	Lock, Spring Retainer	24
	Rod Bearing	6
	Ring Stop	1
	Ring Stop	1
	Ring, Intermediate	6
	Valve Guide	12
	Rod Bearing	6
	Main Bearing	7
	Bushing, Rocker Arm	12
	Bushing, Camshaft	12
	Gasket Set, Intermediate	1
	Piston/Cylinder Kit	6
	Oil Seal	1
	Oil Seal	1
	Intake Valve	6
	Exhaust Valve	6
	Ring Set	6
	Lock, Intake Valve	24
	Cap, Spring	12

MUO	Engine Description	Part No.
8030, 8050, 8070, 4W220		
	670	79017721
	Parts in Kit	Qty
	Piston Kit	6
	Sleeve Kit	6
	Gasket Set, Cylinder Head	1
	Gasket Set, Intermediate	1
	Gasket, Oil Pan	1
	Oil Seal	1
	Oil Seal	1
	Wear Kit, Sleeve	1
	Valve Kit	1
9130, 9150, 9170	BR6L913C	79017828
	Parts in Kit	Qty
	Lock, Intake Valve	24
	Valve Guide	12
	Bushing, Camshaft	12
	Piston/Cylinder Kit	6
	Gasket Set, Intermediate	1
	Oil Seal	1
	Intake Valve	6
	Exhaust Valve	6
	Oil Seal	1
	Ring Set	6
	Cap, Spring	12
9190	BFL513R	79017881
	Parts in Kit	Qty
	Main Bearing	7
	Ring, Backup	4
	Rod Bearing	6
	Rear Oil Seal	1
	Cylinder Kit	6
	Gasket Set, Intermediate	1
	Front Oil Seal	1
	Gasket, Oil Pan	1

DEUTZ-ALLIS

D2506, D3006, D3607, 6035

	F2L912	79017822
	Parts in Kit	Qty
	Lock, Valve	8
	Seal, Shaft	2
	Rod Bearing	2
	Ring, Stop	2
	Ring, Intermediate	2
	Valve Guide	4
	Bushing, Camshaft	4
	Bushing, Rocker Arm	4
	Piston /Cylinder Kit	2
	Main Bearing	3
	Bushing	3

Overhaul Kits

ENGINE

MUO	Engine Description	Part No.
DEUTZ-ALLIS CONTINUED		
D2506, D3006, D3607, 6035 CONTINUED		
	Connecting Rod Bushing	2
	Intake Valve	2
	Exhaust Valve	2
	Lock Valve	8
	Cap, Spring	4
D4006, D4506, D4507, D5009, D5206, D5207, INTRAC 2002, DX3.10, DA6240, DX3.30, DA6250		
	F3L912	79017823
	Parts in Kit	Qty
	Lock, Valve	12
	Rod Bearing	3
	Ring Stop	1
	Ring Stop	1
	Ring, Intermediate	3
	Valve, Guide	6
	Bushing, Rocker Arm	6
	Bushing, Camshaft	6
	Gasket Set, Complete Overhaul	1
	Piston/Cylinder Kit	3
	Main Bearing	4
	Connecting Rod Bushing	3
	Oil Seal	1
	Oil Seal	1
	Intake Valve	3
	Exhaust Valve	3
	Lock, Valve	12
	Cap, Spring	6
D5506, D6006, D6206, D6507, D6507C, D6806, D6807, D7006, D7007, D7007C, D7206, INTRAC 2003, INTRAC 2004, DX3.3, DA6265		
	F4L912	79017824
	Parts in Kit	Qty
	Lock, Valve	16
	Rod Bearing	4
	Ring Stop	1
	Ring Stop	1
	Ring, Intermediate	4
	Valve, Guide	8
	Bushing, Rocker Arm	8
	Bushing, Camshaft	8
	Gasket Set, Complete Overhaul	1
	Piston/Cylinder Kit	4
	Main Bearing	5
	Connecting Rod Bushing	4
	Oil Seal	1
	Oil Seal	2
	Intake Valve	4
	Exhaust Valve	4
	Lock, Valve	16
	Cap, Spring	8

MUO	Engine Description	Part No.
DX90 (76), DX90 (78)		
	F5L912	79017825
	Parts in Kit	Qty
	Lock, Valve	20
	Rod Bearing	5
	Ring Stop	1
	Ring Stop	1
	Ring, Intermediate	5
	Valve, Guide	10
	Bushing, Rocker Arm	10
	Bushing, Camshaft	10
	Gasket Set, Complete Overhaul	1
	Piston/Cylinder Kit	5
	Main Bearing	6
	Connecting Rod Bushing	5
	Oil Seal	1
	Oil Seal	1
	Intake Valve	5
	Exhaust Valve	5
	Lock, Valve	20
	Cap, Spring	10
D8006, D9006, D10006, DX110 (76)		
	F6L912	79017826
	Parts in Kit	Qty
	Lock, Valve	24
	Rod Bearing	6
	Ring Stop	1
	Ring Stop	1
	Ring, Intermediate	6
	Valve, Guide	12
	Bushing, Rocker Arm	12
	Bushing, Camshaft	12
	Piston/Cylinder Kit	6
	Main Bearing	7
	Connecting Rod Bushing	6
	Oil Seal	1
	Oil Seal	1
	Intake Valve	6
	Exhaust Valve	6
	Gasket Set, Complete Overhaul	1
	Lock, Valve	24
	Cap, Spring	12

Overhaul Kits

BEARING RETURN PROCEDURE (FOR DEALER)

You may find you or your customer may require undersized or oversized main or rod bearings, particularly when overhauling an older tractor with a kit that has standard bearings.

1. Complete a Miscellaneous Parts Return Form found on AGCO Solutions® On-Line, or an AGCO Parts Adjustment Request (APAR) Form (Part No. 79015053).
 - (a) Fill in the Standard Crankshaft Bearing quantity and the part number you need to return.
 - (b) In the explanation area, write, "Refer to AGCO Heritage Parts Catalog: Purchased Engine Kit Part No. (kit number you purchased)"
 - (c) Print a copy of your completed Miscellaneous Parts Return form or APAR and place in the box with parts to be returned.
 - (d) Note on the form: "Bearing Return Program."
 - (e) Your Return Request must also include a copy of the kit packing slip and Invoice No., and a copy of your retail receipt.

MUO	Engine Description	Part No.
DX130 (76), DX130 (78), DX140 (76), DX160 (76), DX160 (78), DX6.50, DA7120		
	BF6L913	79017827
	Parts in Kit	Qty
	Lock, Valve	24
	Rod Bearing	6
	Ring, Stop	1
	Ring Stop	1
	Ring, Intermediate	6
	Valve, Guide	12
	Rod Bearing	6
	Main Bearing	7
	Bushing, Rocker Arm	12
	Bushing, Camshaft	12
	Gasket Set	1
	Piston/Cylinder Kit	6
	Oil Seal	1
	Oil Seal	1
	Intake Valve	6
	Exhaust Valve	6
	Ring, Intermediate	6
	Lock, Valve	24
	Cap, Spring	12
DX4.70, DA7085		
	BF4L913 7085	79017954
	Parts in Kit	Qty
	Lock Valve	16
	Ring, Intermediate	4
	Bushing, Rocker Arm	8
	Piston/Cylinder Kit	4
	Gasket Set, Complete Engine	1
	Gasket, Front Cover	1
	Gasket, Oil Pan	1
	Oil Seal	1
	Intake Valve	4
	Exhaust Valve	4
	Oil Seal	1
	Valve Guide	8
	Gasket, Crank Case	1
	Cap, Screw	8

2. Return the parts to:
 - U.S. Dealers – AGCO Parts Division,
1500 N. Raddant Road, Batavia, IL USA 60510-1377
 - Canada Dealers – your Canadian Parts Distribution Center
 - Dealer will be responsible for return freight on the Standard Crankshaft Bearings.
 - Restocking charge will be waived.
3. You have 30 days after the date of retail sale to request a return of Standard Crankshaft bearings.
4. Order replacement undersized crankshaft bearings.
5. Credit will be issued for the price of the returned Standard Crankshaft Bearings at the time your kit was originally shipped.
6. If you have questions about your return, call AGCO Parts Division Dealer Returns.

MUO	Engine Description	Part No.
DX6.30, DA7110		
	7110 F6L913	79018568
	Parts in Kit	Qty
	Main Bearing	7
	Rod Bearing	6
	Piston/Cylinder Kit	6
	Exhaust Valve	6
	Connecting Rod Bushing	24
	Cap, Spring	12
	Valve Guide	12
	Gasket (Single Cylinder)	6
	Gasket Set	1
	Bushing, Rocker Arm	12
	Oil Seal	1
	Oil Seal	1
	Ring, Intermediate	6
	Intake Valve	6
	Connecting Rod Bushing	6



Block Kit Includes: Sleeves, pistons, piston rings, gaskets, thrust washers, olives/washers, seals, bushings

KIT ORDERING GUIDE

1. Locate Tractor or Combine Model
2. Verify Engine / Serial Number Information
3. Locate additional options required for rebuild in the Liners, Pistons and Components section of this catalog
 - a. Upper Gasket Set
 - b. Main Bearing Set
 - c. Rod Bearing Set
 - d. Thrust Washers
 - e. Oil Pump

ENGINE

MUO	Engine Description	Part No.
ALLIS-CHALMERS		
C, CA	B-125	70283103
	Parts in Kit	Qty
	Piston Ring (2nd Compression Ring)	4
	Piston Ring (Scraper)	4
	Piston Ring (Oil)	8
	Piston Liner	4
	Piston (Includes Pin)	4
	Packing, Cylinder Liner	8
WD	W201	79016776
	Parts in Kit	Qty
	Motor Kit (Includes Rings Set,	1
	Piston w/pin, Liner, and Packing)	
	Bearing, Main Half (Center & Rear)	4
	Bearing, Main Half (Front)	2
	Connecting Rod Bearings	8
	Gasket Set, Major Engine Overhaul	1
	Gasket, Rear Bearing Cap	2
	Gasket, Oil Pump Cover	1
	Gasket, Water Pump	1
	Rear Oil Seal, Crankshaft	2
	Front Oil Seal, Crankshaft	1
	Gasket, Thermostat	1
	Gasket, Oil Filter Base	1
	Seal, Magnito	1
	Gasket, Distributor Housing	1
WD45	W226	79016431
	Parts in Kit	Qty
	Piston Assembly (Includes Pin)	4
	Piston Ring, Compression Ring	8

MUO	Engine Description	Part No.
CONTINUED		
	Piston Ring (Oil)	4
	Piston Liner	4
	O-Ring, Cylinder Liner Packing	8
	Piston Ring, Compression Ring	4
	Front Oil Seal, Crankshaft	1
	Instruction Sheet	1
	Bearing, Main Half (Center & Rear)	4
	Bearing, Main Half (Front)	2
	Connecting Rod Bearing	8
	Gasket Set, Major Engine Overhaul	1
	Gasket, Crankshaft, Rear Bearing Cap	2
	Gasket, Oil Pump Cover	1
	Gasket, Water Pump	1
	Rear Oil Seal, Crankshaft	2
	Gasket, Thermostat	1
	Gasket, Oil Filter Base	1
	Seal, Magnito	1
	Gasket, Distributor Housing	1
D15	G149	79016701
Prior to SN 9001	7.5:1 Ratio, 3.496 Bore	
	Parts in Kit	Qty
	Motor Kit	1
	Main Trust Bearing (STD)	2
	Main Bearing (STD)	4
	Connecting Rod Bearings	8
	Gasket Set, Major Engine Overhaul	1

Block Kits

MUO	Engine Description	Part No.
D15	G-160	79016700
Eff. SN 9001	8:1 Ratio, 3.6255 Bore	
	Parts in Kit	Qty
	Piston Assembly	4
	Pin, Piston	4
	Lock, Spring Retainer	8
	Piston Liner	4
	O-Ring, Liner Packing	8
	Retainer, Piston Pin	4
	Piston Ring, Compression (Top)	8
	Piston Ring, Compression (2nd & 3rd)	4
	Instruction Sheet	1
	Main Thrust Bearing (STD)	8
	Main Bearing (STD)	4
	Connecting Rod Bearings	2
	Gasket Set, Major Engine Overhaul	1
D17, 170, 175	G226-8.25:1	79015760
	LP, Gas over 90 Octane	
	Parts in Kit	Qty
	Piston Assembly	4
	Piston Ring, Compression	8
	Piston Ring, Oil (Segment Type, Chrome Face)	4
	Liner, Cylinder	4
	O-Ring, Shaft Housing	8
	Piston Ring, Compression (Top, Chrome Face)	4
	Instruction Sheet	1
	Main Thrust Bearing (STD)	8
	Main Bearing (STD)	4
	Connecting Rod Bearings	2
	Gasket Set, Major Engine Overhaul	1
D17	G226-7.2:1	79016625
	Gas Under 90 Octane	
	Parts in Kit	Qty
	Piston Assembly	4
	Piston Ring, Compression	8
	Piston Ring, Oil (Segment Type, Chrome Face)	4
	Liner, Cylinder	4
	O-Ring, Shaft Housing	8
	Piston Ring, Compression (Top, Chrome Face)	4
	Instruction Sheet	1
	Main Thrust Bearing (STD)	8
	Main Bearing (STD)	4
	Connecting Rod Bearings	2
	Gasket Set, Major Engine Overhaul	1

MUO	Engine Description	Part No.
D19T	262T	79016025
	262T Engines w/ original cam and gear	
	Parts in Kit	Qty
	Piston Kit	6
	Sleeve Kit	6
	Main Bearing Kit	1
	Connecting Rod Bearings	12
	Gasket Set, Major Engine Overhaul	1
D17, D19	D262 Diesel	79016024
	D262 Engines w/ latest cam 74516085 and cam gear 74516088	
	Parts in Kit	Qty
	Piston Kit	6
	Sleeve Kit	6
	Main Bearing Kit	1
	Connecting Rod Bearings	12
	Gasket Set, Major Engine Overhaul	1
D19	G262-8.25:1	79016626
	LP, Gas over 90 Octane	
	Parts in Kit	Qty
	Piston Assembly (Gas)	6
	Sleeve Kit	6
	Main Bearing Kit	1
	Connecting Rod Bearing (STD)	12
	Gasket, Cylinder Head	1
	Gasket Set, Intermediate	1
	Gasket, Oil Pan	2
	Gasket, Oil Drain	1
	Gasket Set, Rear Oil Seal	1
	Rear Oil Seal, Crankshaft	1
	Sleeve, Oil Seal	1
	Front Oil Seal, Crankshaft	1
D19	G262-7.2:1	79016026
	Gas under 90 Octane	
	Parts in Kit	Qty
	Piston Kit	6
	Sleeve Kit	6
	Main Bearing Kit (STD)	1
	Connecting Rod Bearings	12
	Gasket, Cylinder Head	1
	Gasket Set, Intermediate	1
	Gasket, Oil Pan	2
	Gasket, Oil Drain	1
	Rear Oil Seal, Crankshaft	1
	Rear Outer Seal	1
	Sleeve, Oil Seal	1
	Front Oil Seal, Crankshaft	1

Block Kits

ENGINE

MUO	Engine Description	Part No.
ALLIS-CHALMERS CONTINUED		
160, 6040	AD3.152 Diesel	839698M91
	Parts in Kit	Qty
	Washer	10
	Washer (Fuel Flow Meter)	10
	Inj. Olive, 3/16"	10
	Inj. Olive, 1/4"	10
	Thrust Washer	2
	Thrust Washer	2
	Rear Oil Seal	2
	Piston Liner	3
	Connecting Rod Bushing	3
	Front Oil Seal	1
	Gasket, Oil Pan Sides (1 Pair)	1
	Piston Assembly	3
	Spacer	1
	Gasket Set, Lower Overhaul	1
	Gasket Set, Upper Overhaul	1
	Gasket, Oil Pump	1
	Ring Set	3
	Oil Seal	1
	Oil Seal	1
170, 175	G226-8.00:1 Gas under 90 Octane	79018870
	Parts in Kit	Qty
	Motor Kit	1
	Connecting Rod Bearings	8
	Bearing, Main (Front & Rear) (STD)	4
	Bearing, Main (Center) (STD)	2
	Gasket Set, Major Engine Overhaul	1
175	G226-7.2:1 Gas under 90 Octane	79016625
	Parts in Kit	Qty
	Piston assembly	4
	Piston Ring, Compression	8
	Piston Ring, Oil (Segment Type, Chrome Face)	4
	Piston Liner	4
	O-Ring, Packing (Cylinder Liner)	8
	Piston Ring, Compression (Top, Chrome Face)	4
	Piston Ring	8
	Instruction Sheet	1
	Connecting Rod Bearings	8
	Bearing, Main (Front & Rear) (STD)	4
	Bearing, Main (Center) (STD)	2
	Gasket Set, Major Engine Overhaul	1

MUO	Engine Description	Part No.
180, 190	G2600	79016429
	Parts in Kit	Qty
	Piston and Sleeve Kit	6
	Main Bearing Kit	1
	Connecting Rod Bearing (STD)	12
	Gasket Set, Major Engine Overhaul	1
180, 185, 190	D2800	79015489
190XT, 190XTIII	D2900	79015489
	Parts in Kit	Qty
	Piston kit	6
	Connecting Rod Bearing	12
	Main Bearing, Half Kit	5
	Gasket Set, Major Engine Overhaul	1
	Sleeve Kit	6
	Main Bearing (Front & Intermediate)	5
	Main Bearing Kit	1
	Bearing (Center & Lower)	1
	Main Bearing (Rear & Upper)	1
	Main Bearing (Rear & Lower)	1
	Gasket Set, Intermediate	1
	Gasket, Oil Pan	1
	Rear Oil Seal	1
	Wear Kit, Sleeve	1
	Front Oil Seal	1
185, 190, 190XT	G2800	79016418
	Parts in Kit	Qty
	Piston Kit	6
	Sleeve Kit	6
	Main Bearing Kit	1
	Connecting Rod Bearing (STD)	12
	Gasket Set, Major Engine Overhaul	1
200, 7000	D2900	79015490
	Parts in Kit	Qty
	Piston Kit	6
	Connecting Rod Bearing	12
	Main Bearing, Half Kit	5
	Gasket Set, Major Engine Overhaul	1
	Sleeve Kit	6
	Main Bearing (Front & Intermediate)	5
	Main Bearing Kit	1
	Bearing (Center & Lower)	1
	Main Bearing (Rear & Up)	1
	Main Bearing (Rear & Lower)	1
	Gasket Set, Intermediate	1
	Gasket, Oil Pan	1
	Rear Oil Seal	1
	Wear Kit, Sleeve	1
	Front Oil Seal	1

Block Kits

MUO	Engine Description	Part No.
210, 7030, 7040, 7045, 7050, 7060, 7080, 7580	3500	79015492
220	D3500	79015492
	Parts in Kit	Qty
	Piston Kit	6
	Sleeve Kit	6
	Connecting Rod Bearings	12
	Instruction Sheet	1
	Main Bearing (Front & Intermediate, Upper)	5
	Main Bearing (Center & Rear, Upper)	5
	Main Bearing (Center & Rear, Upper)	2
	Main Bearing (Center & Rear, Lower)	2
	Gasket Set, Cylinder Head	1
	Gasket Set, Intermediate	1
	Gasket, Oil Pan	1
	Front Oil Seal	1
	Rear Oil Seal	1
	Wear Kit, Sleeve	1
	Flange Kit, Thrust (STD)	1
6060, 6070, 6080	433I/433T	79015762
	Parts in Kit	Qty
	Piston Kit	4
	Sleeve Kit	4
	Main Bearing (Front & Intermediate)	3
	Main Bearing Connecting Rod	8
	Main Bearing (Front & Intermediate, Upper)	3
	Main Bearing (Center & Upper)	1
	Main Bearing (Center & Lower)	1
	Main Bearing (Rear & Upper)	1
	Main Bearing (Rear & Lower)	1
	Gasket Set, Cylinder Head	1
	Gasket Set, Intermediate	1
	Gasket, Oil Pan	1
	Front Oil Seal	1
	Rear Oil Seal	1
	Wear Kit, Sleeve	1
	Gasket, Oil Drain	1
	Gasket, Exhaust, Turbo	1
7010, 7020	D2900MKII	79015491
8010	649I	79015491
	Parts in Kit	Qty
	Piston Kit	6
	Connecting Rod Bearing	12
	Connecting Rod Bearing	5
	Main Bearing (Front & Intermediate, Lower)	5
	Sleeve Kit	6
	Main Bearing (Center & Upper)	1
	Main Bearing (Center & Lower)	1

MUO	Engine Description	Part No.
CONTINUED	Main Bearings (Rear & Upper)	1
	Main Bearings (Rear & Lower)	1
	Gasket Set, Intermediate	1
	Gasket, Oil Pan	1
	Gasket Set, Cylinder Head	1
	Rear Oil Seal	1
	Wear Kit, Sleeve	1
	Front Oil Seal	1
7120/DX6.50	BF6L913	2928714V
	Parts in Kit	Qty
	Cylinder Assembly (102.00 mm)	1
	Piston Assembly, w/Rings	1
8030, 8050, 8070, 4W220	670	79015493
	Parts in Kit	Qty
	Piston Kit	6
	Sleeve Kit	6
	Connecting Rod Bearing	12
	Instruction Sheet	1
	Main Bearing Kit	5
	Main Bearing (Front & Intermediate)	5
	Main Bearing Kit, Half	2
	Main Bearing (Center & Rear, Lower)	2
	Gasket Set, Cylinder Head	1
	Gasket Set, Intermediate	1
	Gasket, Oil Pan	1
	Front Oil Seal	1
	Rear Oil Seal	1
	Wear Kit, Sleeve	1
8550, 4W305	6120T	79015770
	Parts in Kit	Qty
	Piston Kit	6
	Sleeve Kit	6
	Main Bearing Kit	1
	Flange Kit, Thrust	1
	Connecting Rod Bearing	12
	Gasket Set, Cylinder Head	1
	Gasket Set, Intermediate	1
	Gasket, Oil Pan	1
	Front Oil Seal	1
	Rear Oil Seal	1
	Wear Kit, Sleeve	1

ENGINE

Block Kits

MUO Engine Description Part No.

DEUTZ-ALLIS

D2506, D3006, D3607, 6035, F2L912 2929968V
D4006, D3006, D3607, 6035

1 Per Cylinder

D4006, D4506, D4507, F3L912

D5009, D5206, D5207,
INTRAC 2002, DX3.10,
DA6240, DX3.30, DA6250

1 Per Cylinder

D5506, D6006, D6206, F4L912

D6507, D6507C, D6806,
D6807, D7006, D7007,
D7007C, D7206,

INTRAC 2003, INTRAC 2004,
DX3.3, DA6265

1 Per Cylinder

DX90 (76), DX90 (78) F5L912

1 Per Cylinder

D8006, D9006, D10006, F6L912
DX110 (76)

1 Per Cylinder

MUO Engine Description Part No.

Parts in Kit Qty

Lock Valve, M8 8

Seal, Shaft 2

Rod Bearing (60mm) 2

Ring, Stop 2

Ring, Intermediate 2

Guide/Valve (15mm Rd) 4

Bushing 4

Bushing, Shaft 4

Cylinder, Piston Kit 2

Main Bearing 3

Bushing 3

Bushing 2

Intake Valve 2

Exhaust Valve 2

Lock, Valve 8

Cap, Spring 4

DX130 (76), DX130 (78), BF6L913 2928714V

DX140 (76), DX160 (76),

DX160 (78), DX6.50,

DA7120

1 Per Cylinder

Parts in Kit Qty

Cylinder Assembly (102mm) 1

Piston Assembly, w/Rings 1

ENGINE

Engine Belts

- Select the correct belt.
- Belt Gauge and Sheave Groove Gauge: Two tools in one.
- Always select belt to match Sheave Groove Gauge.
- Use Sheave Groove Gauge to identify the proper belt cross-section.
- Order Part No. 1906302M1

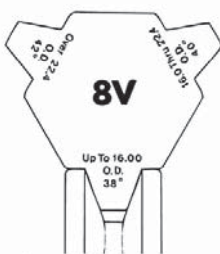

Sheave Groove Gauge

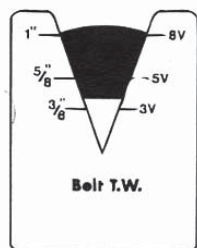

Belt T.W.

Belt Gauge
1906302M1

MUO Belt Application Part No.

ALLIS-CHALMERS

B, IB, C, B-125 Fan w/o Generator 70207003V

Power Unit: B-125 Fan w/ Generator 70209656V

CA Fan w/ Generator 70209656V

WC, WF Fan w/o Generator 70203073V

Power Unit: W-201 Fan w/ Generator 70209824V

WD, WD45 Fan w/o Generator Gas W226 70203073V

Power Unit: W-226 Fan w/ Generator Gas WD, WD45 70209824V

Fan Diesel (Prior to Eng. SN 7785) 70226935V

Fan Diesel (Eff. Eng. SN 7785 Set) 70227471V

Hydraulic Pump (WD45 Gas) 70227398V

Tractor: G Fan w/ Generator 70800116V

Auxiliary Engine: G160 Fan 70233432V

Power Unit: G138, G149, G160 Fan w/o Elect. Start 70209656V

Fan w/ Elect. Start 70207003V

Power Unit: G226 Fan 70229211V

Power Steering Pump 70237386V

Engine Belts

MUO	Belt Application	Part No.
D10, D12	Fan w/Adjustable Water Pump Pulley	70209656V
	Fan w/ Fixed Water Pump Pulley	70233432V
D14 Auxiliary Motor D14	Fan w/Generator	70209656V
	Fan w/o Generator	70207003V
D15	Fan Gas & LPG	70233432V
	Fan Diesel (Set)	70233489V
D17	Fan Gas	70229211V
	Fan Diesel	70229559V
	(Prior to Eng. SN 119938 Except 117087 - 117104) (Set)	
	Fan Diesel	70237048V
	(Eng. SN 117087 - 117104 & Eff. Eng. SN 119938)	
D19	Power Steering Diesel	70235394V
	(Eff. Tractor SN 38964)	
	Power Steering Gas (Eff. Tractor SN 42001)	70237386V
D21	Fan-Early Gas w/ 5" Filler Neck Radiator	70237048V
	Fan Gas & Diesel	70227470V
	Power Steering	70235394V
160	Fan (Set) (Prior to SN 4446)	70240595V
	Fan (Set) (Eff. SN 4446)	70254350V
170, 175	Fan STD & LPG	72074320V
	Fan Basic and Intermediate	70227470V
	Power Steering	72074034V
180, 185	Fan Gas	70248316V
	Fan Diesel	70227470V
190, 190XT	Fan	70243021V
	Fan G2500 Gas (Prior to Eng. SN 2G-05728)	70243021V
	Fan G2500 Gas (Eff. Eng. SN 2G-05728)	70252145V
	Fan G2800 Gas	70252145V
	Fan D2900 (Prior to Eng. SN 2D-25921)	70252145V
200	Fan D2900 (Eff. Eng. SN 2D-25921)	71148120V
	Fan (Set)	70256656V
210, 220	A/C Compressor	70256417V
	Fan (Set)	70254350V
5015	A/C Compressor Laporte Cab	NA
5020, 5030	Fan	72100737V
5040, 5045, 5050	Fan	72097654V
	Fan 5050 (Prior to Eng. SN 700000), 5045	72091544V
5215, 5220, 5230	Fan 5050 (Eff. Eng. SN 700000-799999 & Eff. Eng. SN 220000), 5040	72090561V
	Fan 5214	72103571V
	Fan 5220, 5230 (STD)	72102528V
	Fan 5220, 5230 (w/Power Steering)	72103527V
6040	Clutch; Electric, PTO	NA
6060, 6070, 6080	Fan	70229211V
	Fan	70276499V
	A/C Compressor, 6060 (Prior to SN 3770)	70272411V
	6080 (Prior to SN 4374)	
6140	A/C Compressor, 6060 (Eff. SN 3770)	70562203V
	6080 (Eff. SN 4374), 6070	
6150	Fan	72099473V
	Fan & Blower	03023228V



ENGINE

CHECK ALIGNMENT

Proper alignment is critical to maintain long V-Belt life.

Belt alignment should be checked every time belt maintenance is performed.

Straight edges should touch sheaves at the four points indicated.

Both front and back alignment should be checked.

Engine Belts

ENGINE

MUO	Description	Part No.
ALLIS-CHALMERS, DEUTZ-ALLIS		
7000	Fan (Set)	70260328V
	A/C Compressor (Prior to SN 8001)	70260149V
	A/C Compressor (Eff. SN 8001)	70268485V
7010 & DX 6.30,	Fan (Set)	70254350V
7020, D10006, D8006,	Alternator (Set)	4154401V
DX76 Series, DX90 78 Series	A/C Compressor	70260149V
7030, 7040, 7045,	Fan (Set)	70267630V
7050, 7060	A/C Compressor	70268485V
7080, 7580	Fan (Set)	70269183V
	A/C Compressor, 7080 (Prior to SN 3829), 7850 (Prior to SN 2612)	70268485V
	A/C Compressor (7080 Eff. SN 3829) (7850 Eff. SN 2612)	70261802V
8010	Fan (Set)	70254350V
	A/C Compressor	70260149V
8030, 8050, 8070	A/C Compressor	70268485V
	(Prior to SN 8030-1907) (8050-1837) (8070-1351)	
	A/C Compressor	70273705V
	(Eff. SN 8030-1907) (8050-1837) (8070-1351)	
8550	A/C Compressor (Prior to SN 1636)	20V0008475
	A/C Compressor (Eff. SN 1636)	70226935V
	Water Pump	857029V
	Alternator	70259401V
	Fan (Set)	70259566V
4W220	Fan (Set)	70273193V
	A/C Compressor	70273705V
4W305	Alternator	70259401V
	A/C Compressor	70226935V
	Fan (Set)	70273419V
	Water Pump	74396941V
MUO	Description	Part No.
DEUTZ-ALLIS		
ALTERNATOR BELTS (V-BELTS)		
	6250VF, DX 3.30, 6260FL, DX 3.50, 6275, D6507C, D7007C, D7807C	2235256V
	INTRAC 2002, 2003, 2004	2235255V
	INTRAC 2002, 2003, 2004	1162132V
	D4006, D4506, D5206, D5506, D6006, D6206, D6806, D7206	1162717V
	INTRAC 2002, 2003, 2004, D9006	2235255V
	D6006, D6806	1169889V
	D4006, D4506, D4507, D5206, D5207, D6206, D6207, D6507, D6507C, D6806, D7007, D7007C, D7206, D7207, D7807, D7807C	2235056V
	D4507, D5207, D6207, D7007C, D7807C	2235056V
	D6006, D6806, D6008, D7007, D7007C, D7206, D7207, 7085 (Set)	2235262V
	6240, 6250, 6260, 6265, 6275	1175765V
	6360, 6265, 6275, 6260SC, DX3.50	1175766V
	DX130, DX140/160, 7120, 7145 (Set)	4156783V
	DX130 76 Series, DX130 78 Series, DX140 76 Series, 7120, DX 6.50, 7145, DX 7.10	2235180V
	DX110, DX120	2235532V
	D3006, D3607, 7120, 7145	2235181V
	INTRAC 2002, 2003, 2004	2235254V
	7085, DX4.70, 7120, DX6.50	2235265V

DO NOT MIX NEW AND USED BELTS

Always replace complete V-belt sets with new V-belts. Reusing V-belts where matched sets are required will substantially reduce the life of the drive.

INSTALLATION

WARNING: Always disconnect power supply to machine before removing or installing sheaves or belts.

Never force the belt into a sheave with a screwdriver or wedge. You will rupture the envelope of fabric and break the cords.

Engine Belts

RULES OF V-BELT TENSIONING

- The ideal tension is the lowest tension at which the belt will not slip under peak load conditions.
- Check the belt tension frequently during the first 24-48 hours of run-in operation.
- Do not over-tension belts. This shortens belt and bearing life.
- Keep belts free from foreign material, which may cause slippage.
- Inspect the V-drive periodically. Retension belts if they are slipping.
- Maintain sheave alignment with a strong straight-edge tool while tensioning V-belts.

V-BELT MAINTENANCE

V-belt drive maintenance is not complicated. Inspecting a V-belt is simply a matter of looking and listening. After belt installation or maintenance, inspect the drive and watch it run.

What to Look for

Oil and Grease	Liquids will increase the chance a belt will fail prematurely
Dirt	Impairs traction and increases belt wear
Added Loads	Shorten belt life
Belt Guards	Insure cleanliness and safety
Cracking	Does not reduce tensile strength; larger sheaves and idlers may reduce cracking
Belt Dressing	Do not use any type of belt dressing
Vibration	AKA "Whipping"; Caused by not enough tension
Heat	Causes overcuring, which will shorten belt life
Tension	Proper tension on belts is important
Belt Turnover	Indicates misalignment, worn sheaves or excessive vibration
Change in Rideout	Indicates uneven belt wear or worn sheaves
Lateral Vibration	AKA "Snaking"; Indicates not enough tension
Belt Wear	Wear on belt side-walls indicates consistant slippage, excessive dust or rough sheaves
Foreign Matter	Can cause excessive wear or breakage

What to Listen for

Squeal	Usually indicates insufficient belt tension or overloading
Chirp or Squeak	Usually indicates a dry bearing; realigning the idler may help

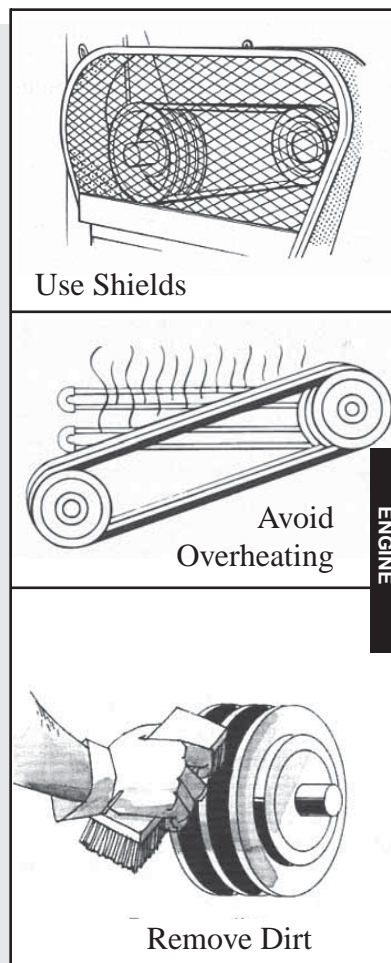

ENGINE

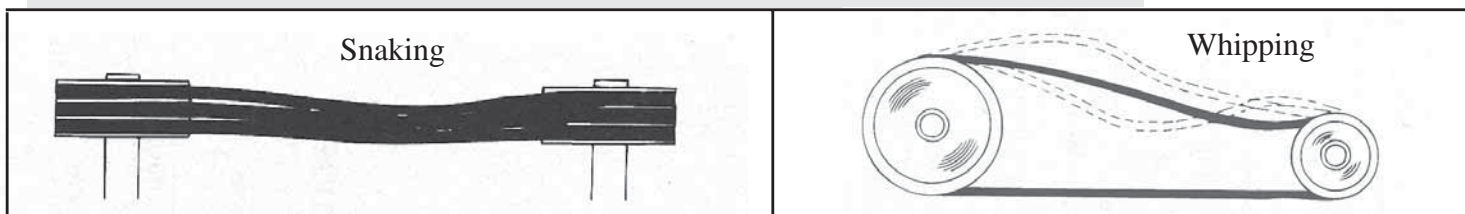

MUO	Part No.
ALTERNATOR BELTS (V-BELTS) CONTINUED	
7085, DX4.70	4154525V
D8006, D10006, DX90, DX110, DX120, 7110	4154401V
D13006 (Eff. SN 7938-0961)	1171907V
Blower (Prior to SN 7937-1200) (Set)	72501439V
Blower (Eff. SN 7937-1200)	2231579V
880 COTTON HARVESTER	
Alternator Belt	71139189V

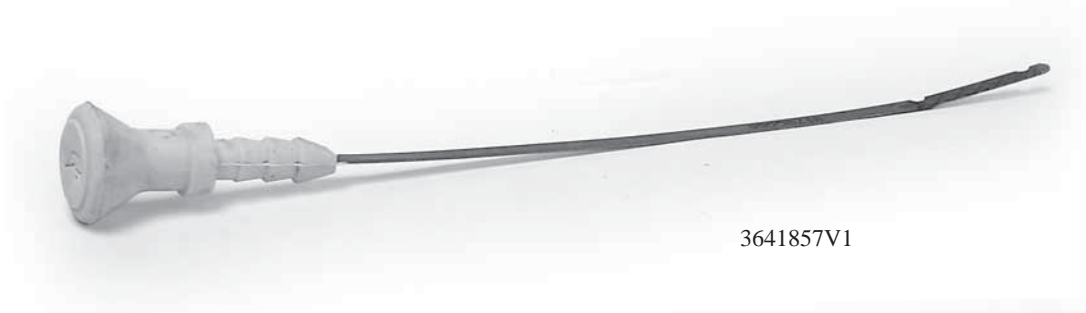

3641857V1



735129V91

Part No.	MUO	Description
----------	-----	-------------

ALLIS-CHALMERS, DEUTZ-ALLIS

DIPSTICK

731117V91	6040	Engine
735129V91	170, 175	Engine

OIL FILL CAPS

72089449V	5040, 5045, 5050	Oil Fill Cap
1236291V	6150, 6240, 6250, 6260, DX3.30-Vario Cab, 6250VF, 6260FV, 6275F, DX3.30VF, DX3.50VF, 7085, 7110, 7120, 7145, 6260, 6265, 6275, DX4.70, DX6.30, DX6.50, DX7.10, DX3.50, DX3.70, DX3.90	Oil Fill Cap w/Seal

GASKETS

70226012V	B, IB, C, CA, WC, WF, WD, WD45, WD45D, D10, D12, D14, D15, D17, D19, D21, 170, 175, 180, 185, 190, 190XT, 190XT III, 200, 210, 220, 220 FWA, 4W220, 4W305, 6060, 6070, 6080, 7000, 7010, 7020, 7030, 7040, 7045, 7050, 7060, 7080, 7580, 8010, 8030, 8050, 8070, 860 Cotton Stripper, 880 Cotton Picker	Gasket - Drain Plug
70233228V	B, IB, C, CA, WC, WF, WD, WD45, D10, D12, D14, D15, D17, 170, 175	Gasket, Oil Filter Base
4154482V	6150, 6240, 6250, 6260, 6265, 6275, DX3.30, DX3.70, DX3.90-Vario Cab, 6260, 6265, 6275, DX3.50, DX3.70, DX3.90-Star Cab, 6250VF, 6260FV, 6275F, DX3.30VF, DX3.50VF, 7085, 7110, 7120, 7145, DX4.70, DX6.30, DX 6.50, DX7.10	Gasket, Oil Filter Base
3362573V	6240, 6250, 6260, DX3.30-Vario Cab, 6262, DX3.50-Star Cab, 6250VF, 6260FV, 6275F, DX3.30VF, DX3.50VF	Gasket, Oil Pan
3362574V	6265, 6275, 7085, DX3.90, DX4.70-Star Cab	Gasket, Oil Pan
3362581V	7110, 7120, 7145, DX6.30, DX6.50, DX7.10	Gasket, Oil Pan
70277026V	WD, WD45, WD45D, D17, D19	Gasket, Oil Pan
734952V91	160, 6040	Gasket, Oil Pan
70203176V	WC, WF, WD, WD45, WD45D, D17, 170, 175	Gasket, Oil Pump Cover
70232325V	B, IB, C, CA, D10, D12, D14, D15	Gasket, Oil Sump
3638780V1	170, 175	Gasket, Rear Housing
70277056V	200, 7000 (Eff. SN 8001), 8010	Gasket Set, Oil Pump & Oil Pan



1236291V

Lubrication

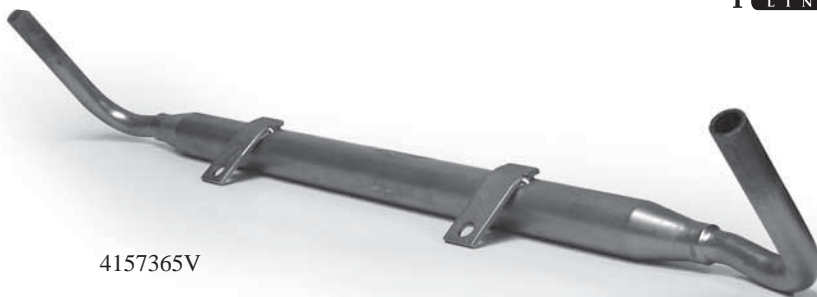

4157365V

Part No.	MUO	Description
OIL COOLER HOSE		
2233328V	7120, 7145, DX6.50, DX7.10	Hose
4157365V	7120, 7145, DX6.50, DX7.10	Oil Line, Bypass



4231921V



4231142V

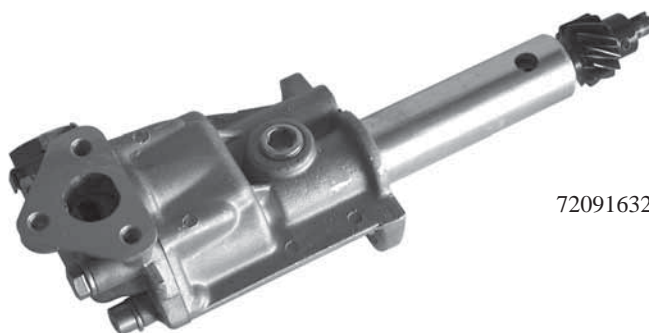

72091632V

Part No.	MUO
OIL PUMP ASSEMBLY	
72091632V	5040, 5045, 5050
3470015V	6035, D3607, D3006
4231307V	6240, 6250, 6260, 6265, 6275, DX3.30, DX3.70, DX3.90-Vario Cab, 6260, 6265, 6275-Star Cab, 6250VF, 6260VF, 6275F, DX3.30VF, DX3.50VF, DX3.50, DX3.70, DX3.90, D4507, D5206, D5207, D5506, D6006, D6206, D6207, D6507, D6507C, D6806, D7007, D7007C, D7206, D7207
4230653V	7085, DX4.70, D10006, D13006, D7807, D7807C, D8006, DX110 76 Series, DX90, 76 Series, DX90 78 Series
4329742V	7085, DX4.70, DX110 76 Series, DX120 76 Series, DX120 78 Series, DX90 76 Series, DX90 78 Series
4231921V	7085, 7110, 7120, 7145
4231142V	DX4.70, DX6.30, DX6.50, DX7.10

Electrical



839012V91

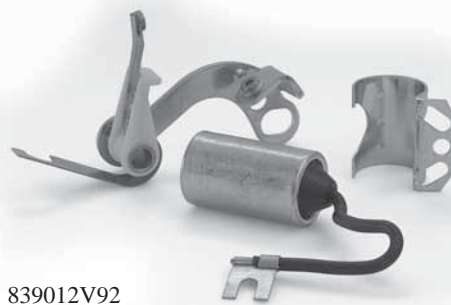

839012V92



70225733V

SEE NEXT PAGE FOR TUNE-UP SPECIFICATIONS

MUO	Dist. Rotor Part No.	Dist. Cap Part No.	P&C Kit Part No.	Ignition Coil Part No.	Wire Set Part No.	Spark Plug Part No.
-----	----------------------	--------------------	------------------	------------------------	-------------------	---------------------

ALLIS-CHALMERS

DISTRIBUTOR IGNITION COMPONENTS

B, C	70225736V	70225733V	70243507V	189673V92	70225485V, 70225485V, 70225487V, 70225488V	79001652V
CA	70225736V	70225733V	70243507V	189673V92	70225485V, 70225485V, 70225487V, 70225488V	79001653V
WD	70225736V	70225733V	70243507V	189673V92	70229867V	79001652V
WD45	70225736V	70225733V	70243507V	189673V92	70229867V	79001654V
G	70225736V	70225733V	70243507V	189673V92	70800139V	79001652V
D10	70225736V	70225733V	70243507V	189673V92	70229867V	79001652V
D12	70225736V	70225733V	70243507V	189673V92	70229867V	79001652V
D14	70225736V	70225733V	70243507V	74061737V	70229867V	79001652V
(Prior to SN 19001)						
D14	70225736V	70225733V	70243507V	189673V92	70229867V	79001652V
(Eff. SN 19001)						
D15	70225736V	70225733V	70243507V	74061737V	70229867V	79001653V
(Except LPG)						
(Prior to SN 9001)						
D15	70225736V	70225733V	70243507V	74061737V	70229867V	79001652V
(Except LPG)						
(Eff. SN 9001)						
D17	70225736V	70225733V	70243507V	74061737V	70229867V	79001652V
(Prior to SN 75001)						
D17	79001168V	74058876V	79001128V	74061737V	70229867V	79001652V
(Prior to SN 75001)						
D17	70225736V	70225733V	79243507V	189673V92	70229867V	79001651V
(Eff. SN 75001)						
D19	NA	74042704V	NA	NA	NA	79001651V
(Prior to SN G05111)						
(Except LPG)						
D19	NA	79001153V	79243507V	189673V92	74512808V	79001651V
(Eff. SN G05111)						
(Except LPG)						
170, 175	74906638V	74058876V	79001128V	189673V92	70229867V	79001651V
180, 185	79001168V	10V3023	79001128V	189673V92	74061039V	74905798V
(Prior to SN 128001)						
190, 190XT	79001168V	10V3023	79001128V	189673V92	74061039V	74905798V

Electrical

Spark Plugs should be removed, cleaned and the points reset after every 200 hours of operation.

TUNE-UP SPECIFICATIONS

"HOT PLUG" Used for heavy fuel "COLD PLUG" Used for gasoline

MUO	Spark Plug Gap	Point Gap	Timing Mark On	Spark Occurs	Firing Order	Intake Valve Clearance	Exhaust Valve Clearance
G	0.025"	0.020"	FP	Notch	1-3-4-2	0.010H"	0.010H"
B, IB	0.035"	0.020"	FLY	TDC	1-2-4-3	0.010H"	0.010H"
WC, WF, WD, WD45	0.030"	0.020"	FLY	TDC	1-2-3-4	0.010H" (WD45 0.012H")	0.010H" (WD45 0.012H")
D10, D12, D17	0.025" (LPG 0.020")	0.022"	FLY	TDC	1-2-4-3	0.013H"	0.013H"
D10 (Eff. SN 3501), D12 (Eff. SN 3001)	0.025" (LPG 0.020")	0.022"	FLY	TDC	1-2-4-3	0.009H"	0.015H"
D14	0.025"	0.020"	FLY	Line (LPG TDC)	1-2-4-3	0.013H"	0.013H"
D15	0.025"	0.022"	FLY	Line	1-2-4-3	0.009H"	0.015H"
D19	0.025"	0.022"	FP	TDC	1-5-3-6-2-4	0.015H"	0.020H"
170 Gas	0.025"	0.022"		BTDC	1-2-4-3	0.01H" to 0.012H"	0.014H" to 0.016H"
175 Gas	0.025"	0.022"		BTDC	1-2-4-3	0.010H" to 0.012H"	0.010H" to 0.012H"
180 Gas	0.025"	0.016"		BTDC	1-5-3-6-2-4	0.020H"	0.025H"
190, 190XT Gas	0.025"	0.016"		BTDC	1-5-3-6-2-4	0.020H"	0.025H"

Abbreviations: TDC-Top Dead Center, BTDC-Bottom Top Dead Center, ATDC-After Top Dead Center, FP-Fan Pulley Drive, FLY-Flywheel
The above specifications taken from machine Operators Manuals.

Part No.	MUO	Heat Range	Thread Size & Hex	Reach, Plug Type/Fuel
SPARK PLUG GUIDE				
79001655V	MINI LOW PROFILE - most outdoor 2 and 4 cycle engines	--	14mm / 13/16"	3/8", Reg./Gas
79001654V	B, IB, C, CA, WC, WF, WD, WD45, D14, D17	Power Units: B-125, G-138, G149, W-201, G-226, W-226, Hot	14mm / 13/16"	3/8", Low/Octane
79001653V	G, B, IB, C, CA, WC, WF, WD, WD45, D10, D12, D14, D15, D17 Cotton Pickers: 616 & 622 w/226 engine	Power Units: 60H, B-125, G-138, G149, G-160, W-201, W-226, G-226 Medium	14mm / 13/16"	3/8", Reg./Gas
79001652V	G, B, IB, C, CA, WC, WF, WD, WD45, D10, D12, D14, D15, D17 Cotton Pickers: 616 & 622 w/226 engine	Power Units: 60H, B-125, G-138, G149, G-160, W-201, W-226, G-226 Cold	14mm / 13/16"	3/8", Reg./Gas
79001651V	D17, DD, 170 Cotton Pickers: 616 & 622 w/226 engine, 801 & 802 w/G-226	Power Units: G-226 Medium	14mm / 13/16"	3/4", Reg./Gas
74905799V	Combines: F Also fits Oliver® & Case	Medium	14mm / 13/16"	3/4", Reg./Gas
74905798V	Tractors: 180, 190 Combines: F, G	Cold	14mm / 13/16"	3/4", Thermal Tip/Gas

Starters and Alternators



89017779V

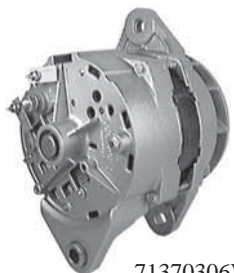

71370306V



89017780V



89017577V

Common Abbreviations

CCW - Counterclockwise

CW - Clockwise

(Number) T - (for example, "10T")-teeth

MUO - Machine Used On

OEM - Original Equipment Manufacturer

PDC - Parts Distribution Center

Part No. Amps/Volts Description

UNIVERSAL APPLICATIONS

ALTERNATORS

89017779V	42 Amp 1-wire	Used to convert an older, generator-equipped tractor to an alternator-equipped version. Produces more output at lower RPM.
71370306V	130 Amp	Used in any larger application with a J-180 mount (4" between bottom mount). Use when upgrading 100 Amp, or when adding additional lighting equipment.
89017780V	63 Amp 1-wire	Designed to produce high output at high RPM. Not recommended for machines that run at idle for long periods of time.

STARTERS

89017577V	12V, CW, 10T	2.8 gear reduction replacement for direct drive starters ranging from 2 - 2.5 kW. Good for very cold and very hot temperatures.
-----------	--------------	---

HOW TO READ THE STARTERS AND ALTERNATORS SECTION

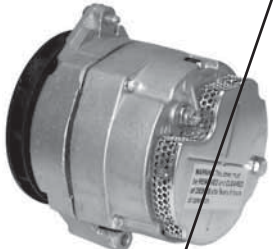
Heritage Part No.	AGCO OEM/REMAN Part No. Equivalent	MUO
 <p>79023138V</p> <p>Heritage Part Number</p>	79005453	Tractors: 7000 (Prior to SN 8001), 649 Allis-Chalmers Eng.
	70266544	Tractors: 7000 Series (55 Amp Delco Remy)
	20-3000545	
	20-3010785	
	30-3228800	
	30-3228789	
	20-7101019	
	20-7101020	
	70262153	
	20-7001446	
79004870		MUO (Machine Used On)
79005608		• 72 Amp
79005610		• Tach Post
		Additional Product Information
		Related OEM Number(s) - for other AGCO brands.
		Remanufactured Part Number(s)- Italic type; sometimes this will be the only number available (prior to the addition of Heritage product). In that case, the remanufactured number will also be boldface type.

OEM Part Numbers-Boldface Type

Starters and Alternators

Heritage Part No.	AGCO OEM/REMAN Part No. Equivalent	MUO
-------------------	------------------------------------	-----

ALLIS-CHALMERS

ALTERNATORS

79023140V	79005453	7000 (Prior to SN 8001), 649 Allis-Chalmers Eng.
	70266544	7000 Series (55 Amp Delco Remy)
	70262153	
	20-3000545	
	20-3010785	• 63 Amp
	30-3228800	• Tach spade terminal
	30-3228789	
	20-7101019	
	20-7101020	
	20-7001446	
	79004870	
79005608		
79005610		
79023138V	79005453	Tractors: 7000 (Prior to SN 8001), 649 Allis-Chalmers Eng.
	70266544	Tractors: 7000 Series (55 Amp Delco Remy)
	70262153	
	20-3000545	
	20-3010785	
	30-3228800	• 72 Amp
	30-3228789	• Dust screen
	20-7101019	• Spade tach terminal
	20-7101020	
	20-7001446	
	79004870	
79005608		
79005610		
1902929V91	79004866	Crawlers: 650, 652, 653 Loaders: 650, 715, TL545H, TL715 Tractors: 7000, 7030, 7040, 7050, 7060, 7080,
	70270835	Tractors: 6060, 6080, 7000 (Eff. SN 8001), 7010, 7020, 8010, 880 Cotton Harvester
	3320296M91	
	579541M91	• 72 Amp
	528353M91	• Tach post
	530342M91	
	588421M91	
	579880M91	
	773324M91	



79023140V

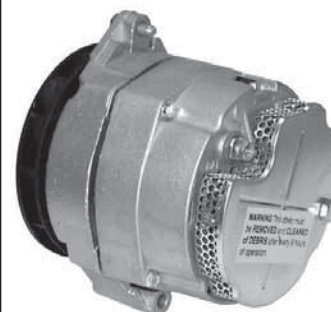

79023138V



1902929V91

Starters and Alternators

Heritage	AGCO	MUO
Part No.	OEM/REMAN	
	Part No. Equivalent	

ALLIS-CHALMERS CONTINUED

ALTERNATORS CONTINUED



79023139V



79009642V

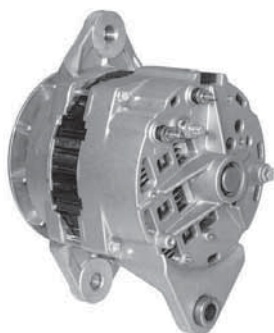

72506406V



30V3435717



1177481V

79023139V	79004866	Crawlers: 650, 652, 653 Loaders: 650, 715, TL545H, TL715 Tractors: 7000, 7030, 7040, 7050, 7060, 7080
70270835		Tractors: 6060, 6080, 7000 (Eff. SN 8001), 7010, 7020, 8010, 880 Cotton Harvester
3320296M91		
579541M91		
528353M91		• 63 Amp
530342M91		
588421M91		
579880M91		
773324M91		
1902929M91		
79009642V	79009642	Tractors: 9130, 9150, 9170, 9190 with 6TI-374 Deutz
	71340355	
	6673145	• 130 Amp
	71339975	
72506406V	72506406	Tractors: 9650, 9670, 9690
	82506406	
		• 130 Amp
30V3435717	30-3435717	Tractors: 5040 with 3-143 UTB
	70264103	Tractors: 4W220, 4W305, 7045, 7060, 7080, 8030, 8050, 8070, 8550
	30R3435717	
		• 105 Amp
1177481V	81177481	Tractors: 5045, 5050 with Bosch
	1177481	
	1171617	• 35 Amp
	1162339	
	1162953	
	1163077	
	33274	
	1163985	
	29281218	

ELECTRICAL

Starters and Alternators

Heritage Part No.	AGCO OEM/REMAN Part No. Equivalent	MUO
-------------------	------------------------------------	-----

ALTERNATORS CONTINUED

1172857V	1172857 <i>81172857</i>	Tractors: 6275, 6265, 7085, 7110, 7120, 7145, 5045, 5050 with Bosch • 65 Amp
-----------------	-----------------------------------	--

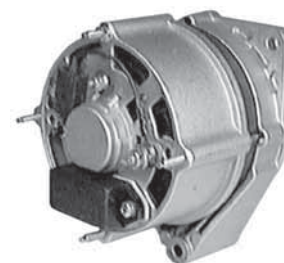

1172857V

72091669V	72091669 72091686 72094123 31-2904525 31-2905991 31-2906131 31-2902278 <i>82091669</i>	Tractors: 5050, 5045 • 33 Amp
------------------	--	---

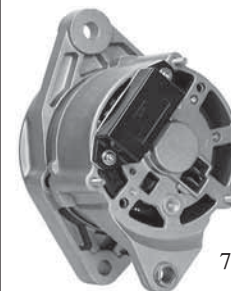

72091669V

30V3302873	30R3302873	Tractors: 7045, 7060, 7080 (1981)
	72088724 30-3210413 30-3210421 30-3228274 30-3302873	Tractors: 5040 • 80 Amp



30V3302873

70273001V	70273001	Tractors: 7580 (1982-85)
	80273001	Tractors: 8010 • 100 Amp



70273001V

STARTERS

79004831V	79004831	Tractors: 180 and 185 (Prior to SN 12800), 190, 190XT, 190XT III
	<i>20-7000396</i>	 • 12V, CW, 9T



79004831V

72272339V	82272339	Tractors: 5670, 5680, 6670, 7630, 7650
	<i>72270794</i>	
	<i>72272339</i>	• 12V, CW, 10T
	<i>72259581</i>	
	<i>72259580</i> <i>72259587</i>	



72272339V

Starters and Alternators

Heritage Part No.	AGCO OEM/REMAN Part No. Equivalent	MUO
-------------------	------------------------------------	-----

ALLIS-CHALMERS CONTINUED

STARTERS CONTINUED



79004848V

79004848V	79004848 79001727	Tractors: 170, 175 • 12V, CW, 10T
------------------	-----------------------------	---



30V3431517

30V3431517	30R3431517 30-3431517 737615 82501755	Crawlers: 650, 652, 653 with 2200 diesel, HD4 • 12V, CW, 10T
-------------------	---	--



71359418V

71359418V	71359418 1173989 1163758 1163756 30-3525228 71357418 72161333 81173989 81359418	Tractors: 7085, 7110, 7120, 7145, 9130, 9150, 9630, 9650 • 12V, CW, 9T
------------------	--	--



72501756V

72501756V	72501756 71359418 1173989 1163758 1163756 30-3525228 71357418 72161333 81173989 81359418	Tractors: 7085, 7110, 7120, 7145, 9130, 9150, 9630, 9650 • 12V, CW, 9T
------------------	--	--



5015254V1

5015254V1	5015254M1	Tractors: 9735, 9745 • 12V, CW, 10T
------------------	------------------	---



79004833V

79004833V	79004833 79001705	Tractors: 210, 220, 220 FWA • 12V, CW, 11T
------------------	-----------------------------	--

ELECTRICAL

Starters and Alternators

Heritage Part No.	AGCO OEM/REMAN Part No. Equivalent	MUO
STARTERS CONTINUED		
79003057V	79003057	Tractors: 6060, 6070, 6080
	70273902	Tractors: 7000, 7020, 8010
	70273901	Tractors: 180, 185, 200, 6060, 6070, 6080, 860 Cotton Stripper, 7000 Series, 8010
	79004832	Tractors: 180 and 185 (Prior to SN 12800), 190, 190XT, 200, 7000 Series
	70270324 74009857 74009182 70256898 71012896 70242143 79001704 79006638	• 12V, CW, 10T
2093256V	82093256	Tractors: 5045, 5050 • 12V, CW, 9T



79003057V



72093256V

DEUTZ-ALLIS

ALTERNATORS

1172857V	1172857	Tractors: 6265, 6275, 7085, 7110, 7120, 7145 • 72 Amp • Dust Screen • Spade tach terminal
	81172857	
1178521V	1178521	Tractors: 6240, 6250, 6260, 6265, 6275, 7085 • 55 Amp
	81178521	
1178607	1178607	Tractors: 6275, 6265, 7085, 7110, 7120, 7145 • 95 Amp
	1177063	



1172857V

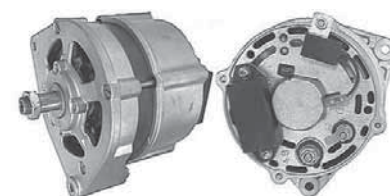

1178521V

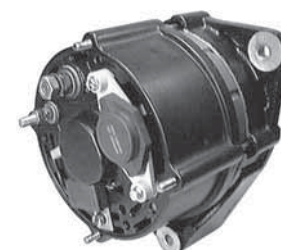

1178607V

Starters and Alternators

Heritage Part No. AGCO OEM/REMAN Part No. Equivalent MUO

DEUTZ-ALLIS CONTINUED

STARTERS



71359418V

71359418V	81359418 81173989	Tractors: 6265, 6275, 7085, 9130, 9150 Tractors: D6250, D6260, D6265, D6275, DX3.30, DX3.70, DX3.90 Combines: M3570, M3580, M3610, M3630, M3640
	71359418	

• 12V, CW, 9T



72501756V

72501756V	72501756 1173989 30-3525228 71359418 1163758 1163756 71357418 72161333 81163758 81359418	Tractors: 6240, 6250, 6260, 6265, 6275, 7085, 7110, 7120, 7145, 9130, 9150, 9630, 9650
------------------	--	---

• 12V, CW, 9T

Alternator Cross-Reference Chart

Manufacturer	OEM Part No.	Heritage Part No.	Manufacturer	OEM Part No.	Heritage Part No.
Bosch	0 120 489 756	1172857V	Caterpillar	0R-1699	30V3435717
Bosch	0 120 339 514	1177481V	Caterpillar	8C-6163	30V3435717
Bosch	0 120 339 531	1177481V	Caterpillar	0R-3616	71358916V
Bosch	0 120 488 185	1178521V	Caterpillar	0R-5205	71358916V
Bosch	0 120 489 309	1178521V	Caterpillar	3E-7982	71358916V
Bosch	0 120 484 001	1178607V	Caterpillar	5S-6698	71358916V
Bosch	0 120 339 515	72091669V	Caterpillar	0R-3527	71370306V
Bosch	0 120 339 516	72091669V	Caterpillar	0R-9480	71370306V
Bosch	0 120 339 527	72091669V	Caterpillar	121-4134	71370306V
Bosch	0 120 339 528	72091669V	Caterpillar	9X-6796	71370306V
Champion Rd. Mach.	57327	30V3435717	Caterpillar	9X-9096	71370306V
Champion Rd. Mach.	42094	79009642V	Caterpillar	7N-8089	79023138V
Case/Case IH	A-163085	79009642V	Caterpillar	2N-5599	79023139V
Case/Case IH	A-181766	79009642V	Cummins	3603877RX	30V3435717
Case/Case IH	A-147160	79023138V	Cummins	3604652RX	30V3435717
Case/Case IH	A-147259	79023138V	Cummins	3604877RX	30V3435717
Case/Case IH	A-160635	79023138V	Cummins	3603850RX	71358916V
Case/Case IH	A-46932	79023138V	Cummins	3604647RX	71358916V
Case/Case IH	A-46938	79023138V	Cummins	3604667RX	71370306V
Case/Case IH	A-47044	79023138V	Cummins	3606667RX	71370306V
Case/Case IH	A-47444	79023138V	Cummins	3604474RX	79009642V
Case/Case IH	A-47625	79023138V	Cummins	3909982	79009642V

Electrical

Alternator Cross Reference Chart Continued

Manufacturer	OEM Part No.	Heritage Part No.	Manufacturer	OEM Part No.	Heritage Part No.
Cummins	EE9021	79009642V	Delco	10459159	71370306V
Delco	10459522	1177481V	Delco	1117909	71370306V
Delco	10459000	30V3435717	Delco	1117910	71370306V
Delco	10459001	30V3435717	Delco	1117923	71370306V
Delco	10459004	30V3435717	Delco	1117941	71370306V
Delco	10459008	30V3435717	Delco	1117943	71370306V
Delco	1117016	30V3435717	Delco	1117966	71370306V
Delco	1117732	30V3435717	Delco	19010145	71370306V
Delco	1117736	30V3435717	Delco	19010147	71370306V
Delco	1117742	30V3435717	Delco	10459040	71370306V
Delco	1117800	30V3435717	Delco	10459026	72506406V
Delco	1117801	30V3435717	Delco	10459039	72506406V
Delco	1117803	30V3435717	Delco	10459042	72506406V
Delco	1117804	30V3435717	Delco	10459043	72506406V
Delco	1117808	30V3435717	Delco	10459044	72506406V
Delco	1117809	30V3435717	Delco	10459045	72506406V
Delco	1117811	30V3435717	Delco	10459104	72506406V
Delco	1117812	30V3435717	Delco	10459158	72506406V
Delco	1117813	30V3435717	Delco	1117885	72506406V
Delco	1117816	30V3435717	Delco	1117886	72506406V
Delco	10459003	71358916V	Delco	1117887	72506406V
Delco	10459014	71358916V	Delco	1117892	72506406V
Delco	10459015	71358916V	Delco	1117905	72506406V
Delco	10459018	71358916V	Delco	1117950	72506406V
Delco	10459019	71358916V	Delco	1117961	72506406V
Delco	10459065	71358916V	Delco	19010105	72506406V
Delco	10459075	71358916V	Delco	19010114	72506406V
Delco	10459077	71358916V	Delco	10479924	79009642V
Delco	1117225	71358916V	Delco	10479925	79009642V
Delco	1117227	71358916V	Delco	10479926	79009642V
Delco	1117228	71358916V	Delco	10479927	79009642V
Delco	1117231	71358916V	Delco	10479930	79009642V
Delco	1117234	71358916V	Delco	10497083	79009642V
Delco	1117240	71358916V	Delco	1101194	79009642V
Delco	1117241	71358916V	Delco	1101205	79009642V
Delco	1117242	71358916V	Delco	1101439	79009642V
Delco	1117244	71358916V	Delco	1101440	79009642V
Delco	1117251	71358916V	Delco	1102551	79009642V
Delco	1117255	71358916V	Delco	1105418	79009642V
Delco	1117261	71358916V	Delco	1105535	79009642V
Delco	1117262	71358916V	Delco	1105536	79009642V
Delco	1117263	71358916V	Delco	1105538	79009642V
Delco	1117264	71358916V	Delco	1105539	79009642V
Delco	1117265	71358916V	Delco	1105540	79009642V
Delco	1117266	71358916V	Delco	1105560	79009642V
Delco	1117268	71358916V	Delco	1105579	79009642V
Delco	1117269	71358916V	Delco	1105605	79009642V
Delco	1117270	71358916V	Delco	1105609	79009642V
Delco	1117271	71358916V	Delco	10459367	79009642V
Delco	1117276	71358916V	Delco	10463346	79023138V
Delco	1117277	71358916V	Delco	10463394	79023138V
Delco	1117278	71358916V	Delco	10463395	79023138V
Delco	10459048	71370306V	Delco	1100171	79023138V

Electrical

Alternator Cross Reference Chart Continued

Manufacturer	OEM Part No.	Heritage Part No.	Manufacturer	OEM Part No.	Heritage Part No.
Delco	1100292	79023138V	Delco	1100166	79023139V
Delco	1101203	79023138V	Delco	1100168	79023139V
Delco	1102922	79023138V	Delco	1100175	79023139V
Delco	1102930	79023138V	Delco	1100176	79023139V
Delco	1102932	79023138V	Delco	1100196	79023139V
Delco	1102937	79023138V	Delco	1100218	79023139V
Delco	1103035	79023138V	Delco	1100221	79023139V
Delco	1103054	79023138V	Delco	1100226	79023139V
Delco	1103127	79023138V	Delco	1100268	79023139V
Delco	1103128	79023138V	Delco	1100543	79023139V
Delco	1103135	79023138V	Delco	1100544	79023139V
Delco	1103141	79023138V	Delco	1100545	79023139V
Delco	1103159	79023138V	Delco	1100546	79023139V
Delco	1103160	79023138V	Delco	1100554	79023139V
Delco	1103165	79023138V	Delco	1100556	79023139V
Delco	1103166	79023138V	Delco	1100563	79023139V
Delco	1103173	79023138V	Delco	1100578	79023139V
Delco	1103184	79023138V	Delco	1100579	79023139V
Delco	1103188	79023138V	Delco	1100588	79023139V
Delco	1105066	79023138V	Delco	1100589	79023139V
Delco	1105073	79023138V	Delco	1100593	79023139V
Delco	1105074	79023138V	Delco	1100798	79023139V
Delco	1105163	79023138V	Delco	1100799	79023139V
Delco	1105165	79023138V	Delco	1100800	79023139V
Delco	1105167	79023138V	Delco	1100801	79023139V
Delco	1105168	79023138V	Delco	1100865	79023139V
Delco	1105169	79023138V	Delco	1100872	79023139V
Delco	1105171	79023138V	Delco	1100873	79023139V
Delco	1105172	79023138V	Delco	1100874	79023139V
Delco	1105173	79023138V	Delco	1100881	79023139V
Delco	1105174	79023138V	Delco	1100882	79023139V
Delco	1105175	79023138V	Delco	1100884	79023139V
Delco	1105176	79023138V	Delco	1100900	79023139V
Delco	1105177	79023138V	Delco	1100911	79023139V
Delco	1105178	79023138V	Delco	1100919	79023139V
Delco	1105188	79023138V	Delco	1100922	79023139V
Delco	1105421	79023138V	Delco	1100923	79023139V
Delco	1105423	79023138V	Delco	1100924	79023139V
Delco	1105424	79023138V	Delco	1100925	79023139V
Delco	1105434	79023138V	Delco	1100936	79023139V
Delco	1105558	79023138V	Delco	1100937	79023139V
Delco	1105559	79023138V	Delco	1100940	79023139V
Delco	1105574	79023138V	Delco	1100946	79023139V
Delco	1105584	79023138V	Delco	1100947	79023139V
Delco	1105619	79023138V	Delco	1100948	79023139V
Delco	1105645	79023138V	Delco	1100950	79023139V
Delco	19020500	79023138V	Delco	1102353	79023139V
Delco	10463067	79023139V	Delco	1102376	79023139V
Delco	10463303	79023139V	Delco	1102380	79023139V
Delco	10463396	79023139V	Delco	1102381	79023139V
Delco	1100125	79023139V	Delco	1102386	79023139V
Delco	1100131	79023139V	Delco	1102387	79023139V
Delco	1100132	79023139V	Delco	1102388	79023139V

Alternator Cross Reference Chart Continued

Manufacturer	OEM Part No.	Heritage Part No.
Delco	1102389	79023139V
Delco	1102390	79023139V
Delco	1102391	79023139V
Delco	1102392	79023139V
Delco	1102399	79023139V
Delco	1102400	79023139V
Delco	1102457	79023139V
Delco	1102460	79023139V
Delco	1102461	79023139V
Delco	1102468	79023139V
Delco	1102469	79023139V
Delco	1102474	79023139V
Delco	1102475	79023139V
Delco	1102476	79023139V
Delco	1102484	79023139V
Delco	1102487	79023139V
Delco	1102500	79023139V
Delco	1102848	79023139V
Delco	1102849	79023139V
Delco	1102851	79023139V
Delco	1102856	79023139V
Delco	1102858	79023139V
Delco	1102863	79023139V
Delco	1102867	79023139V
Delco	1102869	79023139V
Delco	1102878	79023139V
Delco	1102882	79023139V
Delco	1102884	79023139V
Delco	1102893	79023139V
Delco	1102902	79023139V
Delco	1102908	79023139V
Delco	1102909	79023139V
Delco	1102915	79023139V
Delco	1102941	79023139V
Delco	1103036	79023139V
Delco	1103037	79023139V
Delco	1103062	79023139V
Delco	1103063	79023139V
Delco	1103091	79023139V
Delco	1103092	79023139V
Delco	1103105	79023139V
Delco	1103117	79023139V
Delco	1103122	79023139V
Delco	1103153	79023139V
Delco	1103161	79023139V
Delco	1103163	79023139V
Delco	1103168	79023139V
Delco	1103170	79023139V
Delco	1103182	79023139V
Delco	1105033	79023139V
Delco	1105067	79023139V
Delco	1105195	79023139V

Manufacturer	OEM Part No.	Heritage Part No.
Delco	1105365	79023139V
Delco	1105691	79023139V
Delco	1105703	79023139V
Delco	1979860	79023139V
Delco	1979862	79023139V
Delco	1979867	79023139V
Delco	1100118	79023140V
Delco	1100123	79023140V
Delco	1100490	79023140V
Delco	1100491	79023140V
Delco	1100580	79023140V
Delco	1100581	79023140V
Delco	1100582	79023140V
Delco	1100583	79023140V
Delco	1100584	79023140V
Delco	1100585	79023140V
Delco	1100587	79023140V
Delco	1101282	79023140V
Delco	1102359	79023140V
Delco	1102361	79023140V
Delco	1102362	79023140V
Delco	1102363	79023140V
Delco	1102375	79023140V
Delco	1102498	79023140V
Delco	1102578	79023140V
Delco	1102847	79023140V
Delco	1102866	79023140V
Delco	1102876	79023140V
Delco	1102879	79023140V
Delco	1102896	79023140V
Delco	1102898	79023140V
Delco	1102900	79023140V
Delco	1102914	79023140V
Delco	1103040	79023140V
Delco	1103150	79023140V
Delco	1105193	79023140V
Delco	1105361	79023140V
Delco	1105362	79023140V
Delco	1984281	79023140V
Ford/Motorcraft	D7HT-10300-B	30V3435717
Ford/Motorcraft	D7HT-10300-BA	30V3435717
Ford/Motorcraft	D8HZ-10346-E	30V3435717
Ford/Motorcraft	D8HZ-10346-F	30V3435717
Ford/Motorcraft	E4HT-10300-BA	30V3435717
Ford/Motorcraft	E8HZ-10346-A	30V3435717
Ford/Motorcraft	F0HZ-10346-H	30V3435717
Ford/Motorcraft	GL-191	30V3435717
Ford/Motorcraft	GL-259	30V3435717
Ford/Motorcraft	GL-292	30V3435717
Ford/Motorcraft	D4HF-10300-A	71358916V
Ford/Motorcraft	D4HF-10300-AA	71358916V
Ford/Motorcraft	D4HF-10300-C	71358916V

Electrical

Alternator Cross Reference Chart Continued

Manufacturer	OEM Part No.	Heritage Part No.	Manufacturer	OEM Part No.	Heritage Part No.
Ford/Motorcraft	D4HF-10346-C	71358916V	John Deere	TY6600	79023138V
Ford/Motorcraft	D7HZ-10346	71358916V	John Deere	TY6625	79023138V
Ford/Motorcraft	D7HZ-10346-A	71358916V	John Deere	AR54793	79023140V
Ford/Motorcraft	D7HZ-10346-D	71358916V	John Deere	AR54796	79023140V
Ford/Motorcraft	E7HT-10300-CA	71358916V	John Deere	AR56728	79023140V
Ford/Motorcraft	E9HS-10346-AA	71358916V	John Deere	TY6772	79023140V
Ford/Motorcraft	FOHZ-10346-G	71358916V	Khd (Deutz)	1172857	1172857V
Ford/Motorcraft	GL-170	71358916V	Khd (Deutz)	1171617	1177481V
Ford/Motorcraft	GL-192	71358916V	Khd (Deutz)	1177481	1177481V
Ford/Motorcraft	GL-291	71358916V	Khd (Deutz)	29281218	1177481V
International/IH	107601C91	30V3302873	Khd (Deutz)	1175731	1178521V
International/IH	107602C91	30V3302873	Khd (Deutz)	1178521	1178521V
International/IH	146467C91	30V3302873	Khd (Deutz)	1177063	1178607V
International/IH	146475C91	30V3302873	Khd (Deutz)	1178607	1178607V
International/IH	1614822C91	30V3435717	Khd (Deutz)	1178607	1178607V
International/IH	521829C91	30V3435717	Magnetti Marelli	63300900	72091669V
International/IH	521879C91	30V3435717	Magnetti Marelli	63300901	72091669V
International/IH	1202536C91	70273001V	Magnetti Marelli	63300921	72091669V
International/IH	121676C91	70273001V	Magnetti Marelli	AA10814V33A	72091669V
International/IH	131328C91	70273001V	Niehoff	A1-125	30V3302873
International/IH	146472C91	70273001V	Niehoff	N1028	30V3302873
International/IH	146474C91	70273001V	Niehoff	N1029	30V3302873
International/IH	739646C91	70273001V	Niehoff	N1030	30V3302873
International/IH	383290C91	71358916V	Niehoff	N1034	30V3302873
International/IH	511146C91	71358916V	Niehoff	N1035	30V3302873
International/IH	844319C91	71358916V	Niehoff	N1051	30V3302873
International/IH	121918C91	79023138V	Niehoff	N1052	30V3302873
International/IH	130967C91	79023138V	Niehoff	A1-150	70273001V
International/IH	130968C91	79023138V	Niehoff	A1-151	70273001V
International/IH	130973C91	79023138V	Niehoff	N1040	70273001V
International/IH	131104C91	79023138V	Niehoff	N1041	70273001V
International/IH	146443C91	79023138V	Niehoff	N1044	70273001V
International/IH	146444C91	79023138V	Niehoff	N1046	70273001V
International/IH	146445C91	79023138V	Niehoff	N1046	70273001V
International/IH	146446C91	79023138V	Niehoff	N1053	70273001V
International/IH	146446C91	79023138V	Niehoff	N1053-1	70273001V
International/IH	146447C91	79023138V	Niehoff	N1056	70273001V
International/IH	146448C91	79023138V	Niehoff	N1056-1	70273001V
International/IH	500163C91	79023138V	Niehoff	N1060	70273001V
International/IH	571231C91	79023138V	White GMC	V1114255	30V3435717
International/IH	391887C91	79023139V	White GMC	V1114259	30V3435717
International/IH	391890C91	79023139V	White GMC	V1114263	71358916V
International/IH	571232C91	79023139V	White GMC	V1114267	71358916V
International/IH	571233C91	79023139V	White GMC	V1117560	71358916V
International/IH	998659R91	79023140V	Yale	5800018 48	79023139V
John Deere	AZ3846201	1178607V			
John Deere	TY6753	71370306V			
John Deere	AT117390	79009642V			
John Deere	TY6751	79009642V			
John Deere	AR84306	79023138V			
John Deere	AR93446	79023138V			
John Deere	RE13797	79023138V			
John Deere	RE17379	79023138V			

Electrical

Starter Cross Reference Chart

Manufacturer	OEM Part No.	Heritage Part No.	Manufacturer	OEM Part No.	Heritage Part No.
Bosch	0 001 359 038	72272339V	Delco	1114744	79004833V
Bosch	0 001 359 083	72272339V	Delco	1114745	79004833V
Bosch	0 001 359 113	72272339V	Delco	1114787	79004833V
Bosch	0 001 367 005	72272339V	Delco	1114884	79004833V
Case/Case IH	1530289C1	72272339V	Delco	1114886	79004833V
Cummins	3604482RX	30V343151V	Delco	1107859	79004848V
Cummins	3901386	30V343151V	Delco	1998335	79004848V
Cummins	3904445	30V343151V	Delco	1998341	79004848V
Cummins	3909913	30V343151V	Delco	1998403	79004848V
Cummins	3675172RX	89017577V	Delco	10461450	89017577V
Delco	10465149	30V343151V	Delco	10465049	89017577V
Delco	10496882	30V343151V	Delco	10465050	89017577V
Delco	10496883	30V343151V	Delco	1113281	89017577V
Delco	1107589	30V343151V	Delco	1113282	89017577V
Delco	1108698	30V343151V	Denso	028000-6780	79003057V
Delco	1109144	30V343151V	Ford/Motorcraft	E3TF-11000-AA	30V343151V
Delco	1113593	30V343151V	Ford/Motorcraft	E3TZ-11001-B	30V343151V
Delco	1998408	30V343151V	Ford/Motorcraft	E3TZ-11002-B	30V343151V
Delco	1998423	30V343151V	Ford/Motorcraft	E4TF-11000-A	30V343151V
Delco	1998456	30V343151V	Ford/Motorcraft	E4TF-11000-AA	30V343151V
Delco	1998457	30V343151V	Ford/Motorcraft	SA-739	30V343151V
Delco	1998490	30V343151V	John Deere	RE69591	30V343151V
Delco	10479636	5015254V1	John Deere	AR46886	79004833V
Delco	10465055	71359418V	Lucas	26390	72093256V
Delco	10465315	71359418V	Lucas	27430	72093256V
Delco	1113286	71359418V	Magnetti Marelli	MT68R	72272339V
Delco	10479620	72501756V	Magnetti Marelli	MT68RA	72272339V
Delco	1107356	79004831V			
Delco	1108416	79004831V			
Delco	1109435	79004831V			
Delco	1998308	79004831V			
Delco	10461060	79004833V			
Delco	1114110	79004833V			
Delco	1114117	79004833V			
Delco	1114136	79004833V			
Delco	1114139	79004833V			
Delco	1114142	79004833V			
Delco	1114144	79004833V			
Delco	1114151	79004833V			
Delco	1114153	79004833V			
Delco	1114714	79004833V			
Delco	1114734	79004833V			

Electrical

Part No.	MUO	Description
ALLIS-CHALMERS, DEUTZ-ALLIS		
SOLENOIDS		
1174399V	7085, DX4.70, 7110, DX6.30, 7120, DX6.50, 7145, DX7.10	Solenoid Valve
1304451V	Deutz Air-Cooled Engine Applications	Starter Solenoid
1179366V	6250VF, DX3.30VF, 6260FV, DX3.50VF, 6275F, 6265, 6275, DX3.70, DX3.90-Vario Cab, 6265, 6275, DX3.70, DX3.90-Star Cab, 7085, 7110, 7120, 7145, DX4.70, DX6.30, DX6.50, DX7.10	Glow Plug 12V Starter Solenoid
70243828V	D17 (Prior to Series IV), 180, 185 (Prior to SN 12800), 190, 190XT, 190XT III, 200, 7000, 7020	Starter Solenoid



Part No.	MUO	Description
SENDING UNITS		
1177090V	6240, 6250, 6260, 6265, 6275, DX3.30, DX3.70, DZ 3.90-Vario Cab, 6260, 6265, 6275, DX3.50, DX3.70, DX3.90-Star Cab, 7085, 7110, 7120, 7145, DX4.70, DX6.30, DX6.50, DX7.10	Temperature
1173469V	2202/3/4, 6035, D3607, 6240VC, DX3.30VC, 6250VC, DX3.30VC, 6250VF, DX3.30VF, 6260FL, DX3.50FL, 6260SC, DX3.50SC, 6260VC, DX3.50VC, D10006, D13006, D3006, D4006, D4506, D4507, D5206, D5207, D5506, D6006, D6206, D6207, D6507, D6806, D7007, D7007C, D7207, D7807, D7807C, D8006, DX76 Series, DX110 76 Series, DX120 76 Series, DX120 78 Series, DX130 76 Series, DX130 78 Series, DX140 76 Series, DX90 76 Series, DX90 78 Series	Temperature
1178104V	9170, 9190	Oil Pressure
RELAY		
72094115V	5040, 5050	
BATTERY GROUND STRAPS		
70222510V	WD, WD45, WD45D	
70241893V	D10, D12	
70229941V	D14, D17	

Part No.	MUO	Description
VOLTAGE REGULATOR		
1177145V	7085, DX4.70	
1178644V	6240, 6250, 6260, 6265, 6275, DX3.70, DX3.90, DX3.30-Vario Cab, 6260, 6265, 6275, DX3.50, DX3.70, DX3.90-Star Cab, 7085, 7110, DX4.70, DX6.30	
1320407V	6250VF, DX3.30VF, 6260FV, DX3.50VF, 6275F, 7085, DX4.70	
70228365V	D10, D12 (Prior to SN D10-9001 & D12-9001), D14 (Prior to Tractor SN 19001 & Eng. SN 149-19010)	
70229484V	D10 & D12 (Eff. Tractor SN D10-3501 & D12-3001), D14 (Eff. Tractor SN 19001 & Eng. SN 149-19070), D15 (Prior to SN 9001, Gas & LPG), D17 (Series IV), D17 (Prior to Series IV) (Prior to Tractor SN 42001), D19 (Prior to Tractor SN 14698)	
71308106V	6060, 6070, 6080, 7000 (Eff. SN 8001), 7000 (Prior to SN 8001) (Prior to Eng. SN 6237), 7010, 7020, 7030, 7040 (Prior to Eng. SN 3501), 7050, 7060 (Prior to Eng. SN 2513), 7080 (Prior to Eng. SN 1469), 8010, 880 Cotton Harvester	
79004813V	WD, WD45, WD45D, D15	
72093853V	5050	
71311647V	880 Cotton Harvester - 1980, 1981 & 1982	

Switches

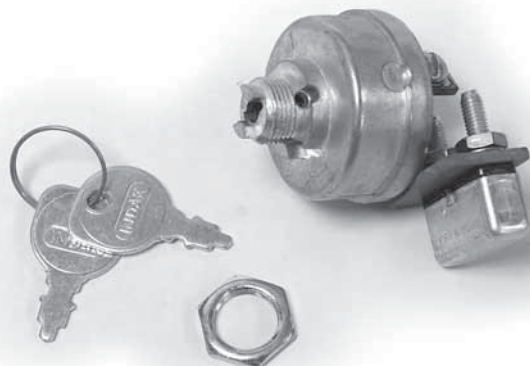

70266612V



72093811V

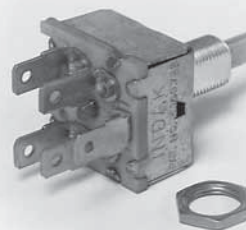

70577454V

Part No.	MUO	Description
SWITCHES		
70253322V	WD, WD45, D15, D17 D19, D21, 170, 175, 180, 185, 190, 190XT, 200, 210, 220, 220 FWA, 7000, 7010, 7020, 7030, 7040, 7045, 7050, 7060, 7080, 7580	Ignition
70241977V	D10, D12, D14, D15, D17, 170, 175, 180, 185, 190, 190XT, 190XT III, 200, 210, 220, 220 FWA, 7000, 7010, 7020, 7030, 7040, 7045, 7050, 7060, 7080, 7580	Ignition
72093812V	5040, 5045, 5050	Ignition
70266612V	7000, 7010, 7020, 7030, 7040, 7045, 7050, 7060, 7080, 7580	Ignition
70241965V	D15, D17 Series IV, 170, 175, 180, 185, 190, 190XT, 190XT III, 200, 210, 220, 220 FWA	Ignition
189158V91	4660, 4W220, 4W305, 5670, 5680, 6045, 6065 ROPS, 6090, 6105, 8010, 8030, 8050, 8070, 880 Cotton Harvester	Push Start Ether
72093811V	5040, 5045, 5050	Lever, Engine Starting Switch
72091942V	5040, 5045, 5050	Safety Start
70253321V	170 (Eff. SN 170-6303), 175, 180, 185, 190, 190XT (Eff. SN 19001), 200, 210, 220, 7000, 7010, 7020, 7040, 7045, 7060, 7080, 7580, 8550	Cap - Starter
70577454V	4W220, 4W305, 6060, 6070, 6080, 7000, 7010, 7020, 7030, 7040, 7045, 7050, 7060, 7080, 7580, 8010, 8030, 8050, 8070	Blower (3 Speed)
4363011V	Star Cab - 6260, 6265, 6275, DX3.50, DX3.70, 3.90, 7085, 7110, 7145, DX4.70, DX6.30, DX7.10	Air Conditioning
70213140V	B, IB, CA, D14, WC, WF, WD, WD45, WD45D	Ground (Shut Off)
70249142V	160, 170, 175, 180, 185, 190, 190XT, 190XT III, 200, 210, 220, 220 FWA, 6040	Lights
72093881V	5040, 5045, 5050	Starting & Lights
1173469V	6250V, 6260F, 6260L, 6275F, 6275L Star Cab: 6260, DX3.50, 6265, DX3.70 Vario Cab: 6150, 6240, 6250, DX3.30, 6260, 6265, DX3.70, 6275, DX3.90	Indicator Light

Lighting



70276912V

70248147V



70248146V



70276913V



961866V1

1628494V1



965465V1

Part No.	MUO	Description
----------	-----	-------------

ALLIS-CHALMERS, DEUTZ-ALLIS

BULBS AND ASSEMBLIES

70276912V	B, IB, C, CA	Lamp Assembly
70276913V	D10, D12, D14, D21	Lamp Assembly
70249147V	170, 175, 180, 185 (Prior to SN 12800), 190, 190XT, 190XT III, 200, 210, 220, 220 FWA	Lamp Assembly, Inner
70249146V	170, 175, 180, 185 (Prior to SN 12800), 190, 190XT, 190XT III, 200, 210, 220, 220 FWA	Lamp Assembly, Outer
961866V1	4650, 4660, 5660, 5650, 5670, 5680, 6045, 6065, 6085, 6090, 6105, 6670, 6680, 6690, 7085, 7110, 7120, 7600, 7630, 7650, 8610, 8630, DX4.70, DX6.30, DX6.50 Star Cab: 6265, DX3.70, 6275, DX3.90 Vario Cab: 6265, DX3.70	Bulb 12V, H/L 45/40W
1628494V1	6065 Cab, 6085, 6105, 6150, 6250VF, 6260FV, 6275F, DX3.30VF, DX 3.50VF Star Cab: 6260, DX3.50, 6265, DX3.70, 6275, DX3.90 Vario Cab: 6240, 6250, DX3.30, 6260, 6265, DX3.70, 6275, DX3.90	Bulb 12V/55W, H3 DIN 72601-YC
965465V1	4650, 5670 (Prior to SN 1500), 6065 Cab, 6085, 6105, 6670, 8610, 8630 Star Cab: 6265, DX3.70, 6275, DX3.90 Vario Cab: 6265, DX3.70	Bulb 12V, 45/40W, Yellow, DIN 72601-A

Filters

ALLIS-CHALMERS BRAND FILTERS FOR MACHINES FROM 1937-1985

MUO	Part No.
Engine Oil Filters, Spin-On	
B, C, CA, WC, WF, WD, WD45, D10, D12, D14, D17	70240912V
7000, 7010, 7020, 7030, 7050, 7060, 7080, 8010, 4W220	74035556V
D17, D19, D21, 180, 185, 190, 190XT, 210, 220, 6060, 6070, 6080	74027979V
200, 7040, 7045, 8030, 8050, 8070, 4W220	74037047V
Hydraulic Filters, Spin-On	
D15, D17, D19, D21, 180, 185, 190, 190XT	70239930V
7010, 7020, 7030, 7040, 7045, 7050, 7060, 7080, 8010, 8030, 8050, 8070	70267600V
190, 190XT, 200, 210, 220, 6060, 6070, 6080	70253952V

See specific model for engine and serial number breaks.



70240912V

MUO	Engine Oil Part No.	Hydraulic System Part No.	
ALLIS-CHALMERS, DEUTZ-ALLIS			
TRACTORS - GAS			
B	70240912V*	Not Required	
C	70240912V*	Not Required	
CA	70240912V*	Not Required	
WC	70240912V*	Not Required	
WF	70240912V*	Not Required	
WD	70240912V*	Not Required	
WD45	70240912V*	Not Required	
D10	70240912V*	70237000V	
D12	70240912V*	70237000V	
D14	70240912V*	Not Required	
D15	70237000V	70239930V*	
D17	70237000V (Eff. SN 24001)	70237000V	Prior to SN 68628
	70240912V* (Prior to SN 24001)	70239930V*	Eff. SN 68628
D19	70237000V	70237000V	Prior to SN 12020
		70239930V*	Eff. SN 12020
170	70237000V	70237000V	Prior to SN 1755845
175	70237000V	70237000V	
180	74027979V*	70237000V	Prior to Eng. SN 2D-92423
190	74027979V*	70253952V*	Eff. SN 25519
		70239930V*	Prior to 25519
190XT	74027979V*	70253952V*	Eff. SN 25519
		70239930V*	Prior to 25519

* Allis-Chalmers Brand Filter

Filters

MUO	Description	Part No.	Notes
ALLIS-CHALMERS, DEUTZ-ALLIS			
TRACTORS - DIESEL			
WD45	Oil Filter Spin-On	70240912V*	
	Element	70240912V*	
D15	Oil Filter Spin-On	NA	
	Hydraulic Filter	70239930V*	
D17	Oil Filter Spin-On	74027979V*	
	Hydraulic Filter	70237000V	Prior to SN 68628
		70239930V*	Eff. SN 68628
D19	Oil Filter Spin-On	74027979V*	
	Hydraulic Filter	70237000V	Prior to SN 12020
		70239930V*	Eff. SN 12020
D21	Oil Filter Spin-On	74027979V*	
	Hydraulic Filter	70239930V*	
170	Oil Filter Spin-On	70237000V	
	Hydraulic Filter	70237000V	
175	Oil Filter Spin-On	70237000V	
	Hydraulic Filter	70237000V	Prior to SN 1755845
180	Oil Filter Spin-On	74027979V*	
	Hydraulic Filter	70239930V*	Prior to SN 12800
185	Oil Filter Spin-On	74027979V*	
	Hydraulic Filter	70239930V*	
190	Oil Filter Spin-On	74027979V*	
	Hydraulic Filter	70239930V*	Prior to SN 25519
		70253952V*	Eff. SN 25519
190XT	Oil Filter Spin-On	74027979V*	
	Hydraulic Filter	70239930V*	Prior to SN 25519
		70253952V*	Eff. SN 25519
200	Oil Filter Spin-On	74037047V*	
	Fuel Filter	71367687V	
	Hydraulic Filter	70253952V*	
210	Oil Filter Spin-On	74027979V*	
	Hydraulic Filter	70253952V*	
220	Oil Filter Spin-On	74027979V*	
	Hydraulic Filter	70253952V*	
4W220	Oil Filter Spin-On	74035556V*	F/2000 & 649 Series
		74037047V*	F/3000 & 670 Series
6060	Oil Filter Spin-On	74027979V*	
	Hydraulic Filter	70253952V*	
6070	Oil Filter Spin-On	74027979V*	
	Hydraulic Filter	70253952V*	
6080	Oil Filter Spin-On	74027979V*	
	Hydraulic Filter	70253952V*	
7000	Oil Filter Spin-On	74035556V*	
	Fuel Filter	71367687V	
7010	Oil Filter Spin-On	74035556V*	
	Hydraulic Filter	70267600V*	Power Direct
		70269856V	Power Shift
7020	Oil Filter Spin-On	74057969V	
	Oil Filter Auxiliary	74035556V*	
	Fuel Filter	71367687V	
	Hydraulic Filter	70267600V*	

MUO	Description	Part No.	Notes
7030	Oil Filter Spin-On	74035556V*	
	Fuel Filter	71367687V	
	Hydraulic Filter	70267600V*	
7040	Oil Filter Spin-On	74037047V*	
	Fuel Filter	71367687V	
	Hydraulic Filter	70267600V*	
		70269856V	Eff. SN 5442 Power Shift
7045	Oil Filter Spin-On	74037047V*	
	Hydraulic Filter	70267600V	
7050	Oil Filter Spin-On	74035556V*	
	Fuel Filter	71367687V	
	Air Filter	NA	
	Safety/Inner	71183993V	
	Hydraulic Filter	70267600V*	
7060	Oil Filter Spin-On	74035556V*	
	Fuel Filter	71367687V	
	Air Filter	NA	
	Safety/Inner	71183993V	
	Hydraulic Filter	70267600V*	
		70269856V	Eff. SN 4087 Power Shift
7080	Oil Filter Spin-On	74035556V*	
	Fuel Filter	71367687V	Prior to SN 3600
	Hydraulic Filter	70267600V*	Prior to SN 2472
7580	Oil Filter Spin-On	74035556V*	
	Fuel Filter	71367687V	
8010	Oil Filter Spin-On	74035556V*	
	Hydraulic Filter	70267600V*	Prior to SN 49K-21508
8030	Oil Filter Spin-On	74037047V*	
	Hydraulic Filter	70267600V*	Power Direct
		70269856V	Power Shift
8050	Oil Filter Spin-On	74037047V*	
	Hydraulic Filter	70267600V*	Power Direct
		70269856V	Power Shift
8070	Oil Filter Spin-On	74037047V*	
	Hydraulic Filter	70267600V*	Power Direct
		70269856V	Power Shift
D4006	Oil Filter Spin-On	1174418V	
	Fuel Filter	1174423V	
	Air Filter	NA	
	Safety/Inner	4308634V	
	Hydraulic Filter	02311975V	Short
D4506	Oil Filter Spin-On	1174418V	
	Fuel Filter	1174423V	
	Air Filter	NA	
	Safety/Inner	4308634V	
	Hydraulic Filter	02311975V	Short
D5206	Oil Filter Spin-On	1174418V	
	Fuel Filter	1174423V	
	Air Filter	NA	
	Safety/Inner	4308634V	
	Hydraulic Filter	02311975V	Short

* Allis-Chalmers Brand Filter

FILTERS

Filters

MUO	Description	Part No.	Notes
TRACTORS - DIESEL CONTINUED			
D6006	Oil Filter Spin-On	1174418V	
	Fuel Filter	1174423V	
	Air Filter	NA	
	Safety/Inner	4308634V	
	Hydraulic Filter	02311975V	Short
D6206	Oil Filter Spin-On	1174418V	
	Fuel Filter	1174423V	
	Air Filter	NA	
	Safety/Inner	4308634V	
	Hydraulic Filter	02311975V	Short
D6806	Oil Filter Spin-On	1174418V	
	Fuel Filter	1174423V	
	Air Filter	NA	
	Safety/Inner	4308634V	
	Hydraulic Filter	02311975V	Short
D7206	Oil Filter Spin-On	1174418V	
	Fuel Filter	1174423V	
	Air Filter	NA	
	Safety/Inner	4308634V	
	Hydraulic Filter	02311975V	Short
D8006	Oil Filter Spin-On	1174421V	
	Fuel Filter	1174483V	Secondary
	Transmission	NA	
	Rear Axle	04306134V	
	Hydraulic Filter	2380014V 2311975V	Long Short
D9006	Oil Filter Spin-On	1174421V	
	Fuel Filter	1174483V	Secondary
D10006	Oil Filter Spin-On	1174421V	
	Fuel Filter	1174483V	Secondary
	Trans./Rear Axle	04306134V	
	Hydraulic Filter	2380014V 2311975V	Long Short
D13006	Oil Filter Spin-On	1174421V	
	Fuel Filter	1174483V	Secondary
	Hydraulic Filter	2380014V 2311975V	Long Short
	D4507	Oil Filter Spin-On	1174418V
Fuel Filter		1174423V	
Hydraulic Filter		04305722V	Cab
D5207	Oil Filter Spin-On	1174418V	
	Fuel Filter	1174423V	
	Hydraulic Filter	04305722V	Cab
D6207	Oil Filter Spin-On	1174418V	
	Fuel Filter	1174423V	
	Hydraulic Filter	04305722V	Cab
D6207C	Oil Filter Spin-On	1174418V	
	Fuel Filter	1174423V	
	Hydraulic Filter	04305722V	Cab

MUO	Description	Part No.	Notes
D6807	Oil Filter Spin-On	1174418V	
	Fuel Filter	1174423V	
	Hydraulic Filter	04305722V	Cab
D70007C	Oil Filter Spin-On	1174418V	
	Fuel Filter	1174423V	
	Hydraulic Filter	04305722V	Cab
D7807C	Oil Filter Spin-On	1174418V	
	Fuel Filter	1174423V	
	Hydraulic Filter	04305722V	Cab
DX90	Oil Filter Spin-On	1174421V	
	Fuel Filter	1174483V	Secondary
	Air Filter	NA	
	Safety/Inner	4319256V	
	Primary/Outer	4319257V	
DX110	Oil Filter Spin-On	1174421V	
	Fuel Filter	1174483V	Secondary
	Air Filter	NA	
	Safety/Inner	4319256V	
	Primary/Outer	4319257V	
DX120	Oil Filter Spin-On	1174421V	
	Fuel Filter	1174483V	Secondary
	Air Filter	NA	
	Safety/Inner	4319256V	
	Primary/Outer	4319257V	
DX130	Fuel Filter	1174483V	Secondary
	Air Filter	NA	
	Safety/Inner	4319256V	
	Primary/Outer	4319257V	
	Hydraulic Filter	04305722V	
DX140, 160			
DX3.10, 6240	Fuel Filter	1174483V	Secondary
	Air Filter	NA	
	Safety/Inner	71183993V	
	Primary/Outer	4319257V	
	Hydraulic Filter	04305722V	
DX 3.30, 6250	Oil Filter Spin-On	1174418V	
	Fuel Filter	1174423V 1174483V	
	Air Filter	NA	
	Safety/Inner	02243521V 04353066V	Under Hood Air Intake
	Primary/Outer	4353065V	Air Intake
DX 3.30, 6250	Hydraulic Filter	04305722V	Cab
	Fuel Filter	1174483V	
	Air Filter	NA	
	Safety/Inner	02243521V	Under Hood
	Hydraulic Filter	04305722V	Cab

FILTERS

Filters

MUO	Description	Part No.	Notes
ALLIS-CHALMERS, DEUTZ-ALLIS			

TRACTORS - DIESEL CONTINUED

DX3.50, 6260			
	Oil Filter Spin-On	1174418V	
	Fuel Filter	1174423V	
		1174483V	
	Air Filter	NA	
	Safety/Inner	02243521V	Under Hood
		04353066V	Air Intake
	Primary/Outer	04353065V	Air Intake
	Hydraulic Filter	04305722V	Cab
	Power Front Axle	4336385V	
DX3.70, 6265			
	Oil Filter Spin-On	1174418V	
	Fuel Filter	1174423V	
		1174483V	
	Air Filter	NA	
	Safety/Inner	02243521V	Under Hood
		04319256V	Air Intake
	Primary/Outer	04319257V	Air Intake
	Hydraulic Filter	04305722V	Cab
	Power Front Axle	4336385V	
DX3.90, 6275			
	Oil Filter Spin-On	1174418V	
	Fuel Filter	1174423V	
		1174483V	
	Air Filter	NA	
	Safety/Inner	02243522V	Under Hood
		04319256V	Air Intake
	Primary/Outer	04319257V	Air Intake
	Hydraulic Filter	04305722V	Cab
	Power Front Axle	4336385V	
DX4.70, 7085			
	Oil Filter Spin-On	1174418V	
	Fuel Filter	NA	Primary
		1174483V	Secondary
	Air Filter	NA	
	Safety/Inner	02243522V	Under Hood
		04319256V	Air Intake
	Primary/Outer	04319257V	Air Intake
	Hydraulic Filter	04305722V	
	Power Front Axle	4336385V	
DX6.30, 7110			
	Oil Filter Spin-On	1174421V	
	Air Filter	NA	
	Safety/Inner	4319256V	
	Primary/Outer	4319257V	
	Hydraulic Filter	4305722V	
	Power Front Axle	4336385V	

MUO	Description	Part No.	Notes
DX6.50, 7120			
	Fuel Filter	NA	Primary
		1174483V	Secondary
	Air Filter	NA	
	Safety/Inner	71183993V	
	Primary/Outer	4319257V	
	Hydraulic Filter	4305722V	
	Power Front Axle	4336385V	
DX7.10, 7145			
	Fuel Filter	NA	Primary
		1174483V	Secondary
	Air Filter	NA	
	Safety/Inner	71183993V	
	Primary/Outer	4319257V	
	Hydraulic Filter	4305722V	
	Power Front Axle	4336385V	
DX8.30, 7190, 6250V			
	Hydraulic Filter	4305722V	
	Oil Filter Spin-On	1174418V	
	Fuel Filter	1174423V	
	Air Filter	NA	
	Safety/Inner	2243521V	
	Hydraulic Filter	4399525V	
	Power Front Axle	4336385V	
6250V, 6260F, 6260LU, 6275F, 6275LU			
	Oil Filter Spin-On	1174418V	
	Fuel Filter	1174423V	
	Air Filter	NA	
	Safety/Inner	2243521V	
	Hydraulic Filter	4399525V	
	Power Front Axle	4336385V	



1447082V1

FILTERS

Fuel Components

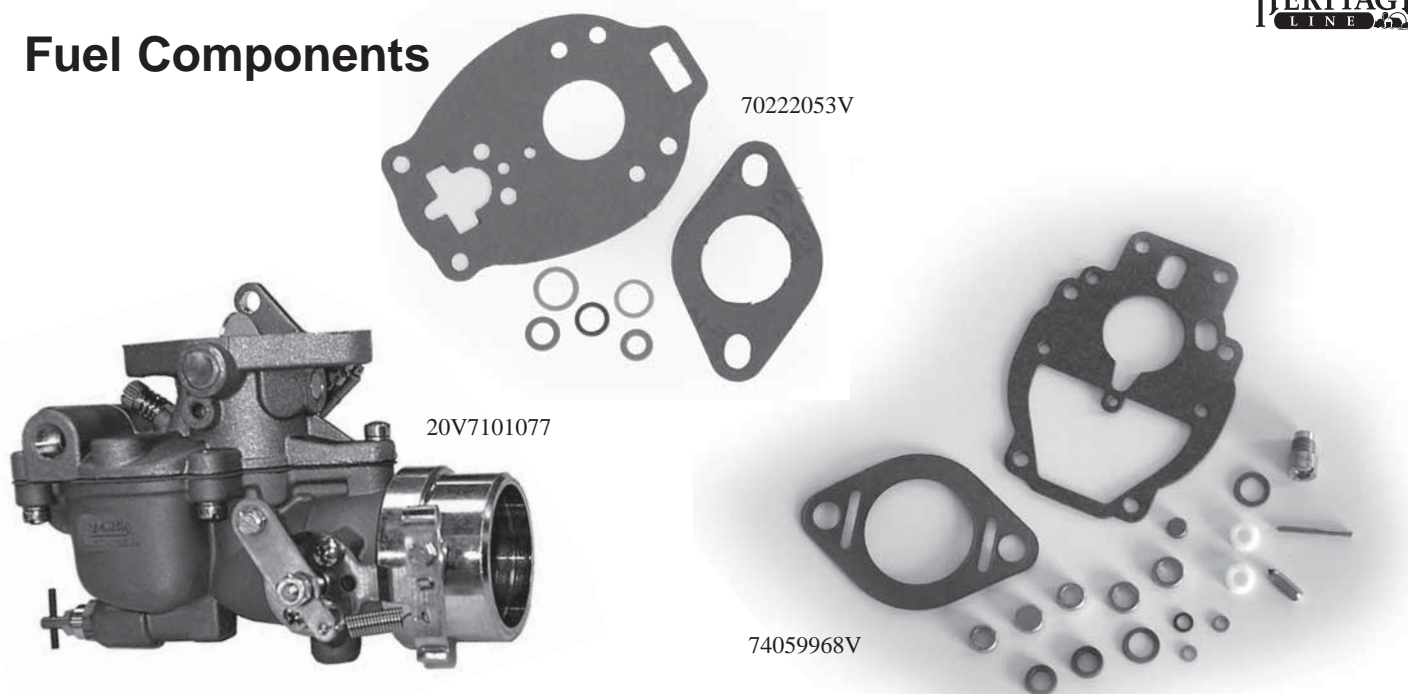

MUO	Manuf.	Outline Number	Carb. Assembly Part No.	Repair Kit Part No.	Gasket Kit Part No.
-----	--------	----------------	-------------------------	---------------------	---------------------

ALLIS-CHALMERS

CARBURETORS

B, C	Zenith	0-10697	70276283V	NA	70224008V
B, C	Marvel-Schebler	TAX-305	NA	NA	70222053V
CA	Zenith	0-11142	NA	70225614V	70224008V
CA	Marvel-Schebler	TSXU-828	NA	NA	70222053V
WC, WF	Zenith	0-7078	NA	NA	70224005V
WC, WF, WD	Zenith	0-9707	70276281V	NA	70224008V
WC, WF, WD	Marvel-Schebler	TSX-159	NA	70257095V	70222053V
WD45	Zenith	0-11588	NA	835924V91	NA
WD45	Marvel-Schebler	TSX-561	NA	70257100V	70226470V
	Marvel-Schebler	TSX-464	NA	70257100V	70226470V
	Marvel-Schebler	TSX-773	NA	70257100V	70226470V
WD45	Marvel-Schebler	TX-871	70276342V	70257100V	70226470V
G	Marvel-Schebler	TSV-13	NA	70800484V	70800483V
D10, D12	Zenith	0-12749	70275480V	70277283V	70224008V
D14, D15 (Prior to SN 9001)	Marvel-Schebler	TSX-815	20V7101077	70257097V	70222053V
	Marvel-Schebler	TSX-670	NA	70257097V	70222053V
	Marvel-Schebler	TSX-701	NA	70257097V	70222053V
D15 (Eff. SN 9001)	Marvel-Schebler	TSX-869	70276342V	70272984V	70226470V
	Marvel-Schebler	NA	NA	70220006V	NA
D17 (Prior to SN 24001)	Zenith	0-12217	70229342V	835924V91	NA
D17 (Eff. SN 24001)	Marvel-Schebler	TSX-871	70276342V	70257100V	70226470V
	Marvel-Schebler	TSX-464	NA	70257100V	70226470V
	Marvel-Schebler	TSX-773	NA	70257100V	70226470V
	Marvel-Schebler	TSX-561	NA	70257100V	70226470V
D19	Marvel-Schebler	TSX-848	74062496V	74056315V	NA
170	Zenith	0-13294	70249982V	70251785V	NA
175	Marvel-Schebler	TSX-928	70248868V	70251721V	70226470
180	Zenith	0-13416	NA	74059968V	74054026V
190 (Eff. SN 16869)	NA	NA	NA	NA	NA
2500 Engine	Zenith	NA	NA	74062473V	74046624V
2800 Engine	Zenith	NA	NA	74062473V	74046624V

Fuel Components

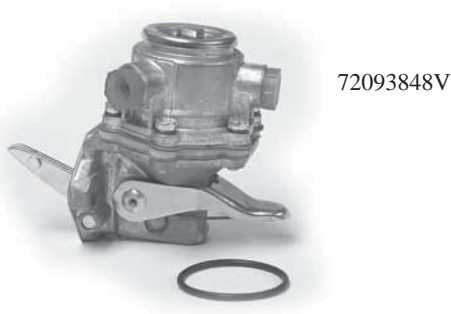
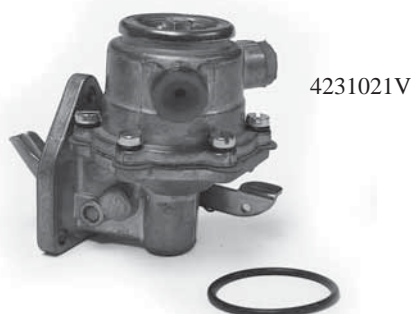

MUO	Pump w/Gasket	Repair Kit	Pump Gasket
ALLIS-CHALMERS, DEUTZ-ALLIS			

FUEL PUMP - GAS			
D19 (Prior to Eng. SN 399494, Except 399131-399237, 399253, 399294-399373)	74055406V	74055537V	74003813V
180, 190	74058966V	NA	70277021V
FUEL PUMP - DIESEL			
5040 for Tractors w/8035.01.306 or 8035.01.309 etched on the nameplate on engine, 5045, 5050 (Eff. Eng. SN 061732)	72093848V	NA	1904903
Vario Cab: 6240, 6250, DX3.30, 6260, DX3.50, 6265, DX3.70, 6275, DX3.90	4231021V	NA	NA
6250VF, 6260FV, 6275F, DX3.30VF, DX3.50VF, 7085, 7110, DX4.70, DX6.30 (Electric)			
7045 (Eff. SN 3732), 7060 (Eff. SN 7824)	70272241V	70272223V	NA
8010 (Prior to SN 2276) (Electric)	70272185V	NA	NA

MUO	Part No.
FUEL PUMP ASSEMBLY - HAND PRIMER	
D15, D21, 185, 180, 190, 190XT, 190XT III, 210, 220, 220FWA	74009409V
CARBURETOR FLOATS	
WD, WD45, D15, D17, 170, 175	70226456V

MUO	Bowl Part No.	Screen Part No.	Gasket Part No.
GLASS FUEL BOWLS			
B, WC (Threaded Bowl)	W2723137V	71151998V	70210188V
B, C (Bail Type)	70237945V	70235555V	70208362V
WC (Bail Type)	70237947V	70208325V	70208137V
G, WD, WD45D Gas, D10	70237945V	70235555V	70208362V
D15 (Prior to SN 9001)	70237945V	70235555V	70208362V
D15 (Eff. SN 9001)	70237947V	70208325V	70208137V
D17 (Prior to SN 42001)	70237945V	70235555V	70208362V
D17 (Eff. SN 42001), F2, K2	70237947V	70208325V	70208137V
D19 (Prior to SN 12000)	70237945V	70235555V	70208362V
D19 (Eff. SN 12000)	70237947V	70208325V	70208137V
D21, L2, M2 (D2900-D3500)	70237947V	70208325V	70208137V
160	72073642V	72073640V	72073641
170 Gas (Prior to SN 170-07500)	70237947V	70208325V	70208137V
170 Gas (Eff. SN 170-07500)	70237945V	70235555V	70208362V
170, 175 Diesel	1024386V1	NA	70208362V
180 Gas	70237945V	70235555V	70208362V
180 Diesel, 185, 190, 210, 220	70237947V	70208325V	70208137V
5020, 5020 FWD, 5030	72098414V	72098412	72098413V
5040, 5045, 5050, 6040, 6140	1039071V1	NA	NA



74009409V



1024386V1



1039071V1



70226456V

FUEL

Fuel Components

Part No.	MUO	Description
FUEL INJECTION GASKETS		
74025150V	D21, 180, 185, 190, 190XT, 190XT III, 200, 210, 220, 220FWA, 7000, 7010, 7020, 7030, 7040, 7045, 7050, 7060, 7080, 7580, 8010, 8030, 8050, 8070, 860 Cotton Stripper	Gasket, Injector Nozzle (12 Per Package)



2233272V

Part No.	MUO	Description
FUEL INJECTION NOZZLES		
72094061V	5040 (6 & 9 Speed), 5045, 5050	Injection Nozzle
2233272V	7120, DX6.50, 7145, DX7.10	Injection Nozzle
72089400V	5040 (8 & 12 Speed) (Melfin), 5045	Injection Nozzle
74007225V	7000 (Eff. SN 8001), 7010, 7020, 880 Cotton Harvester	Injection Nozzle
74036651V	4W220, 7080, 7580, 8030, 8050, 8070	Injection Nozzle (0.36mm Orifice)
2233085V	Vario Cab: 6240, 6250, DX3.30, 6260, 6265, DX3.70, 6275, DX3.90 Star Cab: 6260, DX3.50, 6265, DX3.70, 6275, DX3.90 6250VF, 6260FV, 6275F, DX3.30, DX3.50, 6150, 7085, 7110, DX4.70, DX6.30	Injection Nozzle

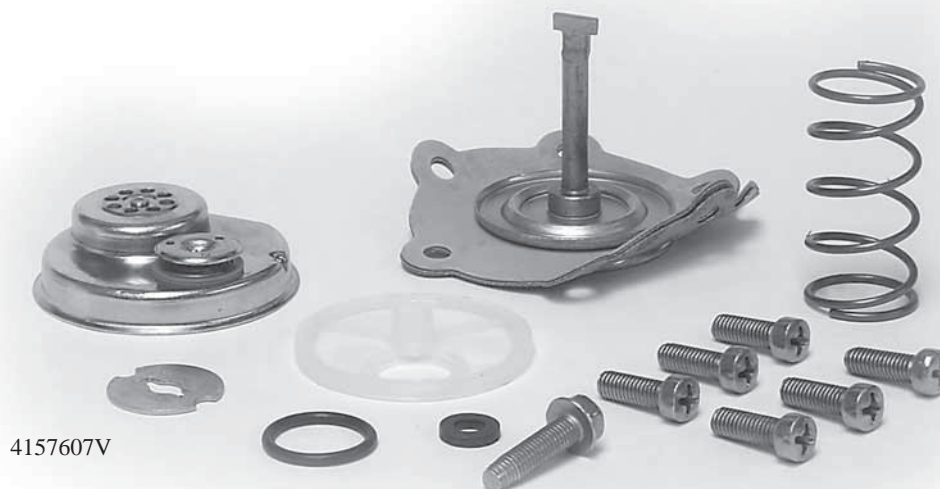

4157607V

Part No.	MUO	Description
FUEL INJECTION PUMP, REPAIR KITS		
1260049V	Vario Cab: 6240, 6250 (Prior to Eng. SN 6972351), 6260, 6265, 6275, DX3.30 (Prior to Eng. SN 6972351), DX3.70, DX3.90 Star Cab: 6260, 6265, 6275, DX3.50, DX3.70, DX3.90 6250VF, 6260FV, 6275F, DX3.30VF, DX3.50VF, 7085, 7110, DX4.70, DX6.30	
4157607V	Vario Cab: 6240, 6275, DX3.90 Star Cab: 6260, DX3.50 6250VF, 6260FV, 6275F, DX3.30VF, DX3.50VF	
4154689V	Vario Cab: 6240, 6250, 6260, 6265, 6275, DX3.70, DX3.90, DX3.30 (Prior to SN 6972351) Star Cab: 6260, 6265, 6275, DX3.50, DX3.70, DX3.90, 6250VF, 6260FV, 6275F, DX3.30VF, DX3.50VF, 7085, 7110, DX4.70, DX6.30	

Fuel Components

Part No. MUO

ALLIS-CHALMERS, DEUTZ-ALLIS CONTINUED

LIFT PUMP

4222104V91	170 (Prior to SN 236U93188), 175 (Prior to SN 248U8332)
3637290V91	170 (Eff. SN 236U93188), 175 (Eff. SN 248U8332)
3637307V91	6040

LIFT PUMP REPAIR KIT

1883344V92	170, 175
------------	----------

LIFT PUMP GASKET

3372182V	6150, 7120, DX6.50, 7145, DX7.10
3638782V1	170 (Prior to SN 236U93188), 175 (Prior to SN 248U8332)
737081V1	160, 6040



422104V92



1883344V92

Part No. MUO

CONTROL CABLES

70236115V	170, 175, 190, 190 XT, 190XT III (Prior SN 13015), 210, 220, 220 FWA, D15, D17 Series IV, D17 Prior to Series IV (Eff. SN 68500), D19	Fuel Shut-Off
70262489V	7000, 7010, 7020, 7030, 7040, 7050, 7060, 7080, 7580	Fuel Shut-Off

FUEL CAP

1244823V	7110, 7120, 7145, DX6.30, DX6.50, DX7.10
----------	--

1244823V



70262489V

Exhaust Systems

70229416V



70225323V

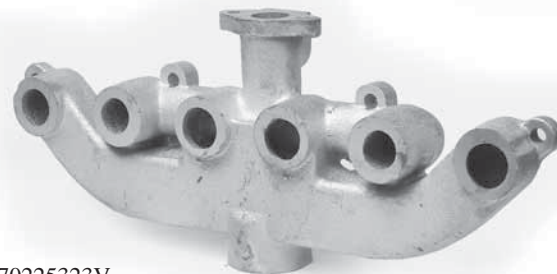

Part No. MUO

ALLIS-CHALMERS, DEUTZ-ALLIS, DEUTZ-FAHR

EXHAUST MANIFOLDS

70225323V	B, IB, C, CA	Intake & Exhaust Manifold Assembly
70257485V	170, 175, D17 Series IV, D17 Prior to Series IV (Eff. SN 32001)	Intake & Exhaust Manifold Assembly
70229416V	WD45 Gas, D17 Prior to Series IV (Prior to SN 3201) Gas and LPG	Intake & Exhaust Manifold Assembly
4152987V	7110, DX6.30	Exhaust Manifold Assembly
2242032V	D5506, D6006, D6206, D6806, D7206	Exhaust Manifold Assembly
740221V1	6040	Exhaust Manifold
4152987V	DX120 78 Series, DX130 78 Series, DX90 78 Series	Exhaust Manifold

EXHAUST GASKETS

74028190V	D19, D21, 180, 185, 190, 190XT, 190XT III, 200, 210, 220, 220 FWA, 4W220, 4W305, 7000, 7010, 7020, 7030, 7040, 7045, 7050, 7060, 7080, 7580, 8010, 8030, 8050, 8070, 8550	Conversion Kit, Turbo Intake Mounting (From Rayjay to Airesearch)
70277061V	180, 185 (Prior to SN 12800), 190, 190XT, 190XT III	Gasket Diesel, Intake & Exhaust Manifold
70277064V	180, 185 (Prior to SN 12800), 190, 190XT, 190XT III	Gasket Gas, Intake & Exhaust Manifold
70229958V	WC, WF, WD, WD45, D17, 170, 175	Gasket Set, Intake & Exhaust Manifold
98489690V	5040, 5045, 5050	Gasket Set, Intake & Exhaust Manifold

Exhaust Systems

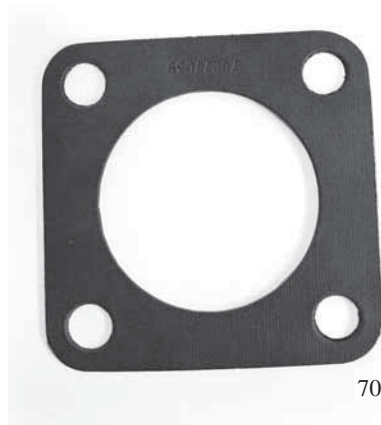

70277039V

Part No.	MUO	Description
EXHAUST GASKETS CONTINUED		
74025376V	D21, 210, 220, 220FWA, 4W220, 7030, 7040, 7045, 7050, 7060, 7080, 7580, 8030, 8050, 8070	Gasket, Air Outlet Elbow (Turbo)
70277039V	D21, 180, 185, 200, 210, 220, 220FWA, 4W220, 4W305, 6060, 6070, 7000, 7080, 7020, 7030, 7040, 7045, 7050, 7060, 7580, 8030, 8050, 8070, 880 Cotton Harvester	Gasket, Air Tube (Turbo)
3640556V1	170, 175	Gasket, Exhaust Manifold
74020090V	180, 185, 190, 190XT, 190XT III, 200, 7000, 7010, 7020, 8010, 860 Cotton Stripper, 880 Cotton Harvester	Gasket, Exhaust Manifold
4222050V1	6040	Gasket, Exhaust Manifold
74027014V	D21, 210, 220, 220FWA, 4W220, 7030, 7040, 7045, 7050, 7060, 7080, 7580, 8030, 8050, 8070	Gasket, Exhaust Manifold
4157247V	Vario Cab: 6240, 6250, 6260, 6265, 6275, DX3.30, DX3.70, DX3.90 Star Cab: 6260, 6265, 6275, DX3.50, DX3.70, DX3.90 6250VF, 6260VF, 6275F, DX3.30VF, DX3.50VF, DX3.50VF, 6150, 7145, 7085, 7110, 7120, DX7.10, DX4.70, DX6.30, DX6.50	Gasket, Exhaust Manifold
70203162V	D17, 170, 175	Gasket, Intake & Exhaust Manifold
70277412V	D21, 210, 220, 220FWD, 4W220, 7030, 7040, 7045, 7050, 7060, 7080, 7580, 8030, 8050, 8070	Gasket, Intake Manifold
71364756V	180, 185, 190, 190 XT, 190XT III, 200, 7000, 7010, 7020, 8010, 860 Cotton Stripper	Gasket, Intake Manifold
4157248V	Vario Cab: 6240, 6250, 6260, 6265, 6275, DX3.30, DX3.70, DX3.90 Star Cab: 6260, 6265, 6275, DX3.50, DX3.70, DX3.90 6250VF, 6260VF, 6275F, DX3.30VF, DX3.50VF, DX3.50VF, 6150, 7145, 7085, 7110, 7120, DX 7.10, DX4.70, DX6.30, DX6.50	Gasket, Intake Manifold
74022852V	180, 185 (Prior to SN 12800)	Gasket, Intake to Exhaust Manifold
70229337V	D10, D12, D14, D15, D17, D19, 170	Gasket, Manifold (#1 & #4)
70229338V	D17, D19, 170, 175	Gasket, Manifold (#1 & #4)
70203163V	D17, D19, 170, 175	Gasket, Manifold (Retainer)
4378883V	7110, DX6.30	Gasket, Muffler
4378888V	Vario Cab: 6240, 6250, 6260, 6265, 6275, DX3.30, DX3.70, DX3.90 Star Cab: 6260, 6265, 6275, DX3.50, DX3.70, DX3.90 7085, DX4.70	Gasket, Muffler
4222475V1	6040	Gasket, Muffler
72094474V	5040, 5045, 5050	Gasket, Muffler
4182520V	7085, 7120, 7145, DX4.70, DX6.50, DX7.10	Gasket, Return Line (Turbo), Asbestos-Free

Mufflers and Supports

Part No. MUO Description

ALLIS-CHALMERS, DEUTZ-ALLIS

MUFFLERS AND SUPPORTS

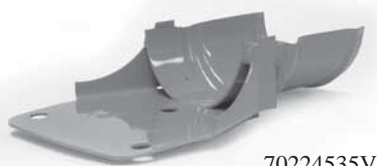

70224535V

4306587V	7110, DX6.30	Muffler
2165302V	10006, 8006, D10006, D8006	Horizontal Muffler
70229531V	WD, WD45, WD45D, D17 Prior to Series IV	Vertical Muffler
70224535V	WD, WD45, WD45D (Eff. SN 17786)	Muffler Support
70271755V	200 (Late), 7000 Diesel (Prior to SN 8553), 190 Diesel Turbo	Muffler

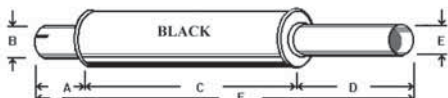

A	B	C	D	E	F	G
INLET LTH.	INLET I. D.	SHELL LTH.	OUTLET LTH.	OUTLET O. D.	O/A LTH.	LB/KG
3-1/2"	3"	32-1/2"	12"	3"	48"	16/7.26



79010606V	B, C, CA (Low Octane Engines)	Vertical Muffler				
A	B	C	D	E	F	G
INLET LTH.	INLET I. D.	SHELL LTH.	OUTLET LTH.	OUTLET O. D.	O/A LTH.	LB/KG
7"	1-3/8"	12-3/4"	9-1/4"	1-1/2"	29"	5/2.27

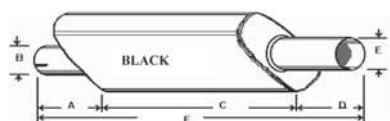

72099119V	5020, 5020 FWD, 5030 (21 HP, 21 HP FWA Eff. SN 8388) (26 HP Eff. SN 4066)	Muffler				
A	B	C	D	E	F	G
INLET LTH.	INLET I. D.	SHELL LTH.	OUTLET LTH.	OUTLET O. D.	O/A LTH.	LB/KG
BENT PIPE	B. PLATE	23"	3"	2"	36"	9/4.1

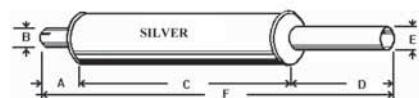

79010607V	WD Gas	Vertical Muffler				
A	B	C	D	E	F	G
INLET LTH.	INLET I. D.	SHELL LTH.	OUTLET LTH.	OUTLET O. D.	O/A LTH.	LB/KG
2-1/4"	1-5/8"	16-1/2"	10-1/4"	1-3/4"	29"	5/2.27

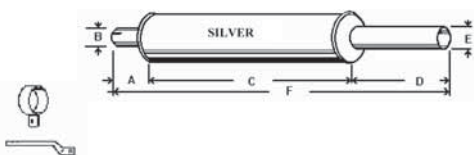

79010608V	B, C, CA - Through Hood, D10, D12, D14, D15 Gas (Prior to SN 9001)	Vertical Muffler				
A	B	C	D	E	F	G
INLET LTH.	INLET I. D.	SHELL LTH.	OUTLET LTH.	OUTLET O. D.	O/A LTH.	LB/KG
2-1/2"	1-3/8"	16-1/2"	10"	1-1/2"	29"	5/2.27

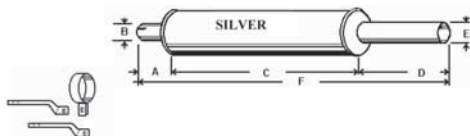

79010609V	WD45 Gas, D17 Gas, LP (Prior to SN 32000)	Vertical Muffler				
A	B	C	D	E	F	G
INLET LTH.	INLET I. D.	SHELL LTH.	OUTLET LTH.	OUTLET O. D.	O/A LTH.	LB/KG
2-1/2"	1-5/8"	16-1/2"	10"	1-3/4"	29"	7/3.18



79010610V	D17 Gas, LP (Eff. SN 32001 - 42000)	Vertical Muffler				
A	B	C	D	E	F	G
INLET LTH.	INLET I. D.	SHELL LTH.	OUTLET LTH.	OUTLET O. D.	O/A LTH.	LB/KG
3/4"	1-15/16"	17"	9-1/4"	2"	29"	6/2.72

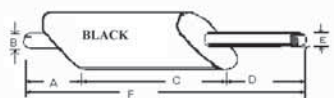

79010612V	D17 Gas (Eff. SN 42001)	Vertical Muffler				
A	B	C	D	E	F	G
INLET LTH.	INLET I. D.	SHELL LTH.	OUTLET LTH.	OUTLET O. D.	O/A LTH.	LB/KG
4-3/4"	1-15/16"	16-1/4"	8"	2"	29"	7/3.18

Mufflers and Supports

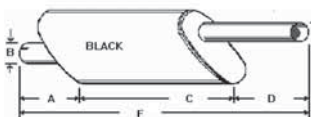
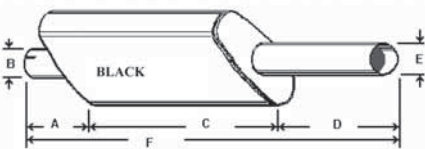
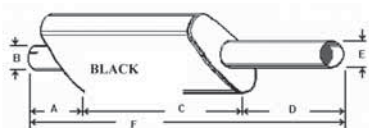
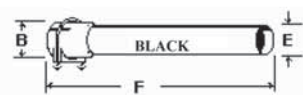
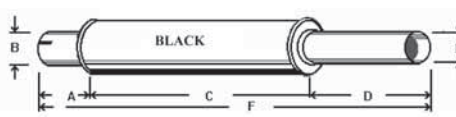
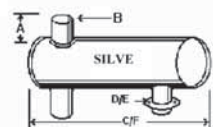
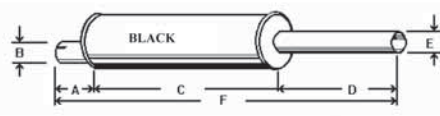
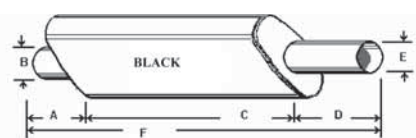
Part No.	MUO	Description				
MUFFLERS AND SUPPORTS CONTINUED						
79010614V	D15 Gas (Eff. SN 9001)	Vertical Muffler				
A	B	C	D	E	F	G
INLET LTH.	INLET I. D.	SHELL LTH.	OUTLET LTH.	OUTLET O. D.	O/A LTH.	LB/KG
3-1/4"	1-3/4"	12-1/2"	12-1/2"	1-3/4"	27"	8/3.63
						
79010616V	170, 175 Gas	Vertical Muffler				
A	B	C	D	E	F	G
INLET LTH.	INLET I. D.	SHELL LTH.	OUTLET LTH.	OUTLET O. D.	O/A LTH.	LB/KG
3-1/2"	1-15/16"	16-1/2"	14"	2"	34"	8/3.63
						
79010617V	180 Gas/Diesel, 185 Diesel	Vertical Muffler				
A	B	C	D	E	F	G
INLET LTH.	INLET I. D.	SHELL LTH.	OUTLET LTH.	OUTLET O. D.	O/A LTH.	LB/KG
2-3/4"	2-3/8"	16-1/4"	15"	2"	34"	11/5
						
79010620V	D21 Diesel, 190 Gas, 190XT Diesel	Muffler - Straight Pipe				
A	B	C	D	E	F	G
INLET LTH.	INLET I. D.	SHELL LTH.	OUTLET LTH.	OUTLET O. D.	O/A LTH.	LB/KG
N/A	3"	N/A	N/A	3"	40"	5/2.27
						
79010621V	190XT, 200 (Early), 210, 220 Diesel	Vertical Muffler				
A	B	C	D	E	F	G
INLET LTH.	INLET I. D.	SHELL LTH.	OUTLET LTH.	OUTLET O. D.	O/A LTH.	LB/KG
4-1/2"	3"	28-1/2"	7"	3"	40"	13/5.9
						
79010623V	190 Gas/Diesel (Eff. SN 19000) (1964-68)	Horizontal Muffler				
A	B	C	D	E	F	G
INLET LTH.	INLET I. D.	SHELL LTH.	OUTLET LTH.	OUTLET O. D.	O/A LTH.	LB/KG
2"	2-3/8"	18"	2-3/4"	2-3/4"	18"	10/4.54
						
79010624V	160 Perkins Diesel, 6040 Diesel	Vertical Muffler				
A	B	C	D	E	F	G
INLET LTH.	INLET I. D.	SHELL LTH.	OUTLET LTH.	OUTLET O. D.	O/A LTH.	LB/KG
2-1/2"	1-11/16"	19-3/4"	12-3/4"	1-3/4"	35"	5/2.27
						
79010625V	7000 (Eff. SN 8553), 7010, 7020, 7030, 7040, 7045, 7050, 7060 All Diesel	Vertical Muffler				
A	B	C	D	E	F	G
INLET LTH.	INLET I. D.	SHELL LTH.	OUTLET LTH.	OUTLET O. D.	O/A LTH.	LB/KG
4"	3"	32-1/4"	11-3/4"	3"	48"	17/7.71
						

Mufflers and Supports

Part No. MUO Description

ALLIS-CHALMERS, DEUTZ-ALLIS CONTINUED

MUFFLERS AND SUPPORTS CONTINUED



79010626V	7085, 7580 Diesel	Vertical Muffler				
A	B	C	D	E	F	G
INLET LTH.	INLET I. D.	SHELL LTH.	OUTLET LTH.	OUTLET O. D.	O/A LTH.	LB/KG
5"	4"	18"	26"	4"	49"	25/11.34

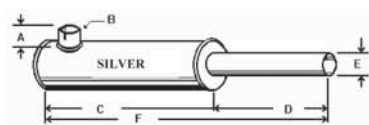

79010628V	B	Horizontal Muffler				
A	B	C	D	E	F	G
INLET LTH.	INLET I. D.	SHELL LTH.	OUTLET LTH.	OUTLET O. D.	O/A LTH.	LB/KG
2-1/4"	2-3/8"	19"	8"	2-1/4"	27"	6/2.72

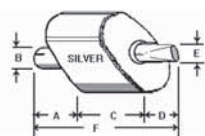

79012173V	B, C, CA - Under Hood Muffler	Vertical Muffler				
A	B	C	D	E	F	G
INLET LTH.	INLET I. D.	SHELL LTH.	OUTLET LTH.	OUTLET O. D.	O/A LTH.	LB/KG
1"	1-3/8"	4-1/4"	3-3/4"	BENT PIPE	9"	3/1.36

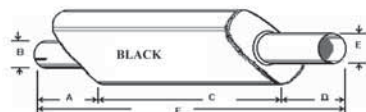

79012175V	6060, 6070, 6080	Vertical Muffler				
A	B	C	D	E	F	G
INLET LTH.	INLET I. D.	SHELL LTH.	OUTLET LTH.	OUTLET O. D.	O/A LTH.	LB/KG
3"	3"	18-1/2"	24-1/2"	3"	46"	15/6.8

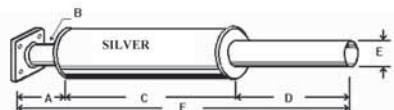

79015986V	D15 Diesel (Prior to SN 9001), D17 Diesel (Prior to SN 38964)	Vertical Muffler				
A	B	C	D	E	F	G
INLET LTH.	INLET I. D.	SHELL LTH.	OUTLET LTH.	OUTLET O. D.	O/A LTH.	LB/KG
3"	B. PLATE	16-1/2"	6-1/2"	2-1/4"	26	5/2.27

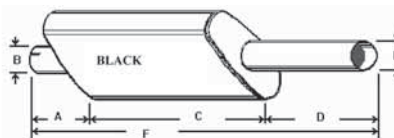

79015987V	D15 Diesel (Eff. SN 9001), D17 Diesel (Eff. SN 38964)	Vertical Muffler				
A	B	C	D	E	F	G
INLET LTH.	INLET I. D.	SHELL LTH.	OUTLET LTH.	OUTLET O. D.	O/A LTH.	LB/KG
3"	2-3/8"	16"	8"	2"	27"	8/3.63



79015988V	190 Gas (Eff. SN 19001)	Vertical Muffler				
A	B	C	D	E	F	G
INLET LTH.	INLET I. D.	SHELL LTH.	OUTLET LTH.	OUTLET O. D.	O/A LTH.	LB/KG
3"	2-3/8"	28-1/2"	18-1/2"	2-1/2"	50"	12/5.44

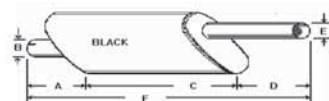

79015989V	D10, D12 Gas (Eff. SN 9001)	Vertical Muffler				
A	B	C	D	E	F	G
INLET LTH.	INLET I. D.	SHELL LTH.	OUTLET LTH.	OUTLET O. D.	O/A LTH.	LB/KG
7/8"	1-3/8"	16-1/4"	13-1/2"	1-1/2"	33-1/4"	7/3.18

Mufflers and Supports

Part No.	MUO	Description				
MUFFLERS AND SUPPORTS CONTINUED						
79015993V	D19 Gas	Vertical Muffler				
A	B	C	D	E	F	G
INLET LTH.	INLET I. D.	SHELL LTH.	OUTLET LTH.	OUTLET O. D.	O/A LTH.	LB/KG
2-3/4"	2-3/8"	16-1/2"	7-3/4"	2"	27"	7/3.18
79015994V			170, 175 Diesel, 180 Gas	Vertical Muffler		
A	B	C	D	E	F	G
INLET LTH.	INLET I. D.	SHELL LTH.	OUTLET LTH.	OUTLET O. D.	O/A LTH.	LB/KG
3/4"	2-3/8"	16-1/4"	15"	2-1/4"	34"	8/3.63

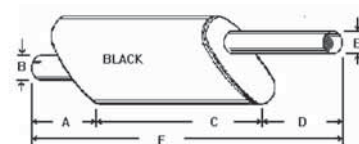
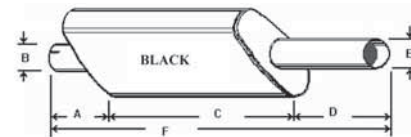

Universal Exhaust Accessories

RAIN CAPS Bright Finish

Part No.	Fits pipe O.D.
70244381V	For 1-1/2" O.D. Pipe
70244342V	For 1-3/4" O.D. Pipe
70236922V	For 2" O.D. Pipe
70253310V	For 1-3/4" O.D. Pipe
70252842V	For 2-1/2" O.D. Pipe
70244343V	For 2-7/8" O.D. Pipe
1498008V1	For 3" O.D. Pipe
70244344V	For 3" O.D. Pipe
70275328V	For 3-1/4" O.D. Pipe



70256539V

CURVED EXHAUST EXTENDERS

Part No.	Inside Diameter	Overall Length
79023416V	1-1/2"	18"
79023417V	1-3/4"	18"
79023418V	2"	18"
79023419V	2-1/4"	18"
79023420V	2-1/2"	18"
79023421V	2-3/4"	18"
79023422V	3"	18"
79023423V	2-5/8"	18"
79023424V	3-1/2"	20"
79023425V	3-3/4"	20"
79023426V	4"	20-1/2"
79023427V	4-1/8"	20-1/2"
79023428V	4-1/2"	20-1/2"
79023429V	5"	20-1/2"

MUFFLER CLAMPS

Saddle-Type Clamps

Part No.	Fits pipe O.D.
79023401V	For 1-1/2" Pipe
79023402V	For 1-5/8" Pipe
79023403V	For 1-3/4" Pipe
79023404V	For 1-7/8" Pipe
79023405V	For 2" Pipe
79023406V	For 2-1/4" Pipe
79023407V	For 2-1/2" Pipe
79023408V	For 2-5/8" Pipe
79023409V	For 2-3/4" Pipe
79023410V	For 3" Pipe
79023411V	For 3-1/4" Pipe
79023412V	For 3-1/2" Pipe
79023413V	For 4" Pipe
79023414V	For 4-1/2" Pipe
79023415V	For 5" Pipe
70256539V	For 3-1/2" O.D. Pipe
70269408V	For 4" O.D. Pipe
1092639V1	For 2-3/4" O.D. Pipe
166206AV	For 3-1/2" O.D. Pipe
1498008V1	For 3-1/2" O.D. Pipe
70269408V	For 4" O.D. Pipe
20V7003002	For 5" O.D. Pipe
70253311V	For 2.38" O.D. Pipe
192791V91	For 2.20" O.D. Pipe

Universal Exhaust Accessories

Part No.	Inside Diameter
BLACK STRAIGHT PIPES - 24" LONG PIPE	
79023430V	1-1/2"
79023431V	1-3/4"
79023432V	2"
79023433V	2-1/4"
79023434V	2-3/8"
79023435V	2-1/2"
79023436V	2-5/8"
79023437V	2-3/4"
79023438V	3"
79023439V	3-1/2"
79023440V	3-3/4"
79023441V	4"
79023442V	4-1/2"
79023443V	5"

Part No.	Inside Diameter
BLACK STRAIGHT PIPES - 48" LONG PIPE	
79023444V	1-1/2"
79023445V	1-3/4"
79023446V	2"
79023447V	2-1/4"
79023448V	2-3/8"
79023449V	2-1/2"
79023450V	2-5/8"
79023451V	2-3/4"
79023453V	3"
79023454V	3-1/2"
79023455V	3-3/4"
79023456V	4"
79023457V	4-1/2"
79023458V	5"

Air Intake

Part No.	MUO	Description
ALLIS-CHALMERS, DEUTZ-ALLIS		
AIR CLEANER HOSES		
70243175V	180, 185 (Prior SN 12800), 185 (Eff. SN 12800), 190, 109XT, 190XT III	Air Cleaner Hose Diesel
70250281V	190, 190XT, 190XT III	Air Hose To Carburetor
70240866V	190, 190XT, 190XT III, 200, 7000 (Prior to SN 8001), D21, 860 Cotton Stripper, 880 Cotton Harvester	Hose, Air Cleaner Tube To Heater Housing
GASKETS		
74338943V	D21, 210, 220, 220FWA, 4W220, 7030, 7040, 7045, 7050, 7060, 7080, 7580, 8030, 8050, 8070	Gasket, Diffuser
BREATHER VALVE		
2239105V	7085, DX4.70	Diaphragm (Breather Valve)
COLD WEATHER STARTING AID		
893501V91	160 (Prior to SN 0143067), 170, 175	Heater, Air Intake Manifold



2239105V

Air Intake



4318399V



1693129V1



70651270V



71125804V



70651270V

Part No.	MUO	Description
PRECLEANERS		
71306480V	Vario Cab: 6240, 6250, 6260, 6265, 6275, DX3.30, DX3.70, DX3.90 Star Cab: 6260, 6265, 6275, DX3.50, DX3.70, DX3.90 D4507, D5207, D6207, D6507, D6507C, D7007, D7007C, D7207	Pre-Cleaner Assembly
4318399V	7085, DX4.70, 7120, DX6.50, 7145, DX7.10, D1006, D13006, DX110 76 Series, DX120 76 Series, DX120 78 Series, DX130 76 Series, DX130 78 Series, DX140 76 Series, DX90 76 Series, DX90 78 Series	Pre-Cleaner Assembly
4318403V	7145, 7120, DX7.10, DX6.50, 7085, DX4.70, D10006, D13006, DX110 76 Series, DX120 76 Series, DX120 78 Series, DX130 76 Series, DX130 78 Series, DX140 76 Series, DX90 76 Series, DX90 78 Series	Pre-Cleaner Assembly
1693129V1	6240VC, DX3.10, 6250VC, DX3.30, 6260 SC, DX3.50, 7085, DX4.70, D4507, D5207, D6207, D6507, D6506C, D7007, D7007C, D7207	Pre-Cleaner Assembly
3380636V1	7085, DX4.70, 7120, DX6.50, 7145, DX7.10, D1006, D13006, DX76 Series, DX110 76 Series, DX120 76 Series, DX120 78 Series, DX130 76 Series, DX130 78 Series, DX140 76 Series, DX90 76 Series, DX90 78 Series	Pre-Cleaner Assembly
70651270V	170, 175, 180, 185, 190, 190XT, 190XT III, 200, 210, 220, 220FWA, 6060, 6070, 6080, 7000, 7010, 7020, 7030, 7040, 7045, 7050, 7145, DX7.10, D21, 7085, 7110, 7120, DX4.70, DX6.30, DX6.50	Pre-Cleaner Bowl (Plastic)
71125804V	Vario Cab: 160, 6040, 6240, 6250, 6260, 6275, DX3.30, DX3.90 Star Cab: 6260, 6265, 6275, DX3.50, DX3.70, DX3.90	Pre-Cleaner Bowl (Plastic)
1508881V1	6240, 6240VC, DX3.10, 6250VC, DX3.30, 6260SC, DX3.50, 6260VC, DX3.50, 7085, DX4.70, D10006, D13006, D4507, D5207, D6207, D6507, D6507C, D7007, D7007C, D7207, D7807, D7807C, D8006	Pre-Cleaner Bowl (Plastic)

Cooling Systems



70270151V



70228545V



4151103V



70258541V

Part No.	MUO	Description
----------	-----	-------------

ALLIS-CHALMERS, DEUTZ-ALLIS

BLOWER MOTOR - AIR CONDITIONING

70275685V	6060 (Eff. SN 10306), 6080 (Eff. SN 10306)	
-----------	--	--

RADIATOR CAP

70254891V	B, IB, C, CA, WC (Eff. SN 74330), WF (Eff. SN 1904), WD, WD45, WD45D, D10, D12 Series II, D14, D15, D17, D19, D21, 170, 175, 180, 185, 190, 190XT, 190XT III, 200, 210, 220, 220FWA, 7000, 7010, 7020, 7030, 7040, 7045, 7050, 7060, 7080, 7580	
-----------	--	--

70228545V	WC, WF, WD, WD45, WD45D	
-----------	-------------------------	--

RADIATORS

70228585V	WC, WD, WD45 Gas	
-----------	------------------	--

70233232V	B, C, CA, D10, D12	
-----------	--------------------	--

70270151V	7060 (Eff. SN 6001)	
-----------	---------------------	--

HYDRAULIC BLOWER

4151103V	7145, DX7.10, 7085, DX4.70, 7110, DX6.30, 7120, DX 6.50	Coupling, Clutch (Hydraulic Blower)
----------	--	--

RADIATOR HOSES

70258541V	4W220, 7580	Hose, Lower
-----------	-------------	-------------

70243015V	190, 190XT, 190XT III (Prior to SN 14450)	Hose, Lower
-----------	---	-------------

70248233V	180, 185, 190, 190XT, 190XT III (Eff. SN 14450)	Hose, Lower
-----------	---	-------------

Cooling Systems



70243014V



4182519V



70277294V



70228542V

Part No.	MUO	Description
RADIATOR HOSES CONTINUED		
70243014V	180, 185, 190, 190XT, 190XT III	Hose, Upper
70267816V	7030, 7040, 7045, 7050, 7060, 7580, 7080	Hose, Upper
GASKETS		
4182519V	7085, 7120, 7145, DX4.70, DX6.50, DX7.10	Gasket, Blower Pipe
4222057V1	160	Gasket, Upper Radiator
70277028V	D15, D17	Gasket, Water Outlet
70277038V	D21, 210, 220, 220FWA, 4W220, 7030, 7040, 7050, 7060, 7080, 7580, 8030, 8050, 8070,	Gasket, Intercooler Core to Thermostat Housing
70277294V	WC, WF, WD, WD45, WD45D, D17, 170, 175	Gasket, Water Manifold
745106V1	170, 175	Gasket, Thermostat
70277062V	180, 185 (Prior to SN 12800) Gas, 190, 190XT, 190XT III, 200	Gasket, Thermostat Housing
70277063V	D21, 180, 185, 190, 190XT, 190XT III, 200, 210, 220, 220FWA, 4W220, 7000, 7030, 7040, 7045, 7050, 7060, 7080, 7580, 8010, 8030, 8050, 8070	Gasket, Water Inlet Pipe
70277032V	D17, D19	Gasket, Water Pump To Block
70228542V	WC, WF, WD, WD45, WD45D (Prior to SN 289000), D10, D12S, D14, D15, D17, 170, 175	Gasket, Thermostat
70230643V	B, IB, C, CA, WD, WD45, WD45D (Prior to SN PU-97614), D10, D12 Series II, D14	Gasket, Thermostat
70228125V	D10, D12 Series II, D14, D15	Gasket, Thermostat Cover

Cooling Systems

Part No.	MUO	Description
ALLIS-CHALMERS, DEUTZ-ALLIS CONTINUED		
GASKETS CONTINUED		
71364762V	D21, 180, 185, 200, 210, 220, 220 FWA, 4W220, 7000, 7010, 7020, 7030, 7040, 7045, 7050, 7060, 7080, 8010, 8030, 8050, 8070	Gasket, Thermostat Housing
74023504V	180, 185, 190, 190XT, 190XT III, 200, 7000, 7010, 7020, 8010	Gasket, Thermostat Housing
74513722V	WD45 (Eff. Eng. SN 121524), D17 (Eff. Eng. SN 117087-117104) D17 (Eff. Eng. SN 119938), D19	Gasket, Thermostat Housing
71364767V	D21, 180, 185, 190, 190XT, 190XT III, 200, 210, 220, 220FWA, 4W220, 4W305, 6060, 6070, 6080, 7000, 7010, 7020, 7030, 7040, 7045, 7050, 7060, 7080, 7580, 8010, 8030, 8050, 8070, 8550	Gasket, Thermostat
4222057V1	160, 6040	Gasket, Upper Thermostat
74023554V	180, 185, 190, 190XT, 190XT III, 200, 7000, 7010, 7020, 8010	Gasket, Water Outlet
70277125V	D17 (Eff. Eng. SN 117087-117104) D17 (Eff. Eng. SN 119938)	Gasket, Water Outlet
70203061V	B, IB, C, WC, WF, WD, WD45, WD45D, D17, 170, 175	Gasket, Water Pump to Block
74026887V	D21, 5040, 5045, 5050	Gasket, Water Outlet
74026887V	180, 185 (Eff. SN 2G-13863 & 2D-49082), 190, 190XT, 190XT III, 200, 210, 220, 220FWA, 4W220, 7000, 7030, 7040, 7045, 7050, 7060, 7080, 7580, 8010, 8030, 8050, 8070	Gasket, Water Pump
74335456V	180, 185, 190, 190XT, 190XT III	Gasket, Thermostat (Dynaseal)

Cooling Systems



71312851V

Part No.	MUO	Description
SENDING UNITS		
71312851V	860 Cotton Stripper, 880 Cotton Harvester	Sending Unit, Water Temperature, 1/2 NPT



70268708V



4823211V

Part No.	MUO
THERMOSTATS	
70268708V	7030, 7040, 7045, 7050, 7060, 7580, 7080
1446165V91	170, 175, 6040
4823211V	5040, 5045, 5050
74025103V	D17, D19, D21, 180, 185, 190, 190XT, 190XT III, 200, 210, 220, 220FWA, 4W220, 6060, 6070, 6080, 7000, 7010, 7020, 7030, 7040, 7045, 7050, 7060, 7080, 7580, 8010, 8030, 8050, 8070, 860 Cotton Stripper, 880 Cotton Harvester
4189704V	7145, 7085, 7110, 7120, DX4.70, DX6.30, DX6.50, DX7.10

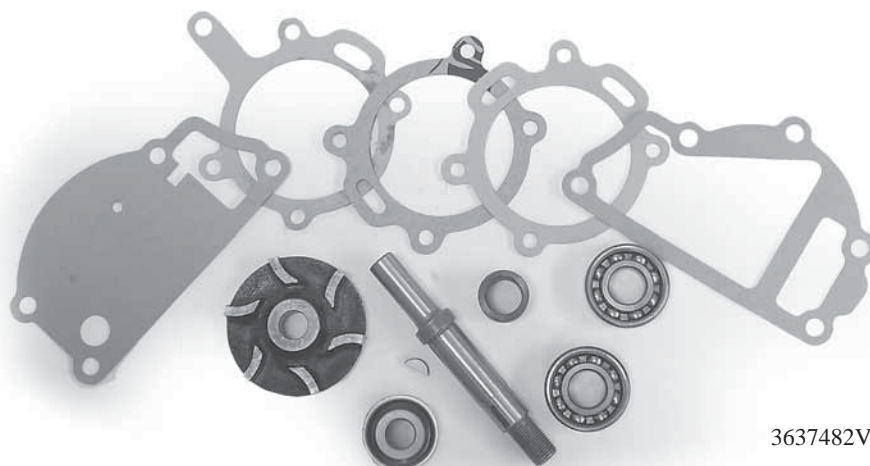

3637482V91

Part No.	MUO	Description
WATER PUMPS		
79016822V	WC, WF, WD, WD45	Water Pump Assembly
WATER PUMP REPAIR KITS		
79003714V	170, 175 (Eff. SN 236U70098080 & SN 248U9346)	Kit, Water Pump (w/Ceramic Seal)
3637482V91	170, 175 Diesel (Eff. SN 236U70098080 & SN 248U9346)	Kit, Water Pump (w/Ceramic Seal)
731774V91	160	Water Pump Repair Kit

Front Axle and Steering

MUO	Part No. Spindle (L)	Upright (Dia. Spec.)	Part No. Spindle (R)	Upright (Dia. Spec.)	Description
ALLIS-CHALMERS					
SPINDLES					
D14 Roll Shift Axle	70237434V	12"	70237434V	12"	5 Bolt Hub
D15 Roll Shift Axle	70237434V	12"	70237434V	12"	5 Bolt Hub
D15 (Eff. SN 22414)	70270044V	11.7"	70270044V	11.7"	Standard
D15 (Eff. SN 22414)	70270043V	16.35"	70270043V	16.35"	High Clearance
D17 Roll Shift Axle (Prior to SN 83272)	70237434V	12"	70237434V	12"	5 Bolt Hub
D17 Roll Shift Axle	70244059V	12"	70244059V	12"	Cane Tractor
D17 Roll Shift Axle (Eff. SN 83273)	70270043V	16.35"	70270043V	16.35"	High Clearance
D17 Roll Shift Axle (Eff. SN 83273)	70270044V	11.7"	70270044V	11.7"	Standard
D19 Roll Shift Axle	70262782V	14"	70262782V	14"	Hi Clearance
170, 175 Roll Shift Axle (Prior to SN 170-7500, 175-2035)	70270038V	12"	70270038V	12"	12 Degree Standard
170, 175 Roll Shift Axle (Prior to SN 170-7500, 175-2035)	702700400V	12"	702700400V	12"	10 Degree Standard
170, 175 Roll Shift Axle (Prior to SN 170-7500, 175-2035)	70244059V	12"	70244059V	12"	Cane Tractors
170, 175 Roll Shift Axle (Prior to SN 170-7500, 175-2035)	70270043V	12"	70270043V	12"	10 Degree Hi Clearance
180, 185 (Prior to SN 12800)	70262782V	14"	70262782V	14"	Hi Clearance
180, 185 (Prior to SN 12800)	70270044V	11.7"	70270044V	11.7"	Standard
185 (Eff. SN 12800)	70262782V	14"	70262782V	14"	Hi Clearance
185 (Eff. SN 12800)	70270038V	12"	70270038V	12"	12 Degree Standard
185 (Eff. SN 12800)	70270044V	11.7"	70270044V	11.7"	Standard
190, 190XT, 190XT III	70262782V	14"	70262782V	14"	10 Degree
190, 190XT, 190XT III	70262799V	14"	70262799V	14"	12 Degree
190, 190XT, 190XT III	70244059V	18.5"	70244059V	18.5"	Hi Clearance
200	70262782V	14"	70262782V	14"	Hi Clearance
200	70244059V	18.5"	70244059V	18.5"	Cane Tractors
5015, 5215 HST, 5215 Synchro-Shift	72100886V	9.5"	3284558V91	9.5"	
5020, 5020 FWD, 5030	72098428V	11.5"	72098429V	11.5"	
5045	72090684V	13"	72090685V	13"	
5050	72090684V	13"	72090685V	13"	
5220 Synchro-Shift, 5230 Synchro-Shift	72102816V	10.8"	72102816V	10.8"	
5670 (Prior to SN 1500), 5670 (Eff. SN 1500), 5680	72231479V	15"	72231478V	15"	
6060, 6070 2WD	70263173V	15.5"	70263173V	15.5"	96" Tread
6060, 6070 2WD	70263173V	15.5"	70263173V	15.5"	96" Tread
6080 2WD	70263173V	15.5"	70263173V	15.5"	96" Tread
7000	70270050V	10 Degrees	70270050V	10 Degrees	Service with matched set
7000	70261052V	12 Degrees	70261052V	12 Degrees	Service with matched set
7000, 7010, 7020, 7030, 7040, 7045, 7050, 7060, 7080	70267779V		70267780V		Heavy-Duty Front Axle
7010, 7020, 7045, 7060	70262663V		70262662V		Hi Clearance
8010, 8030, 8050	70262663V		70262662V		Hi Clearance
8010, 8030, 8050, 8070	70267779V		70267780V		Heavy-Duty Front Axle

Front Axle and Steering

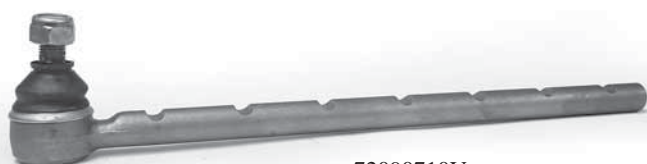

72090710V



72093231V



72090449V



72090115V



72093230V



72091309V



70256144V



70254662V



72090448V

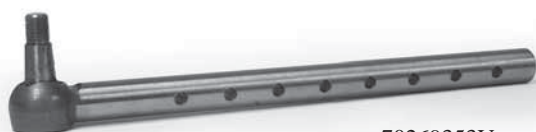

70269353V



70254661V

Part No.	MUO	Description
ALLIS-CHALMERS, DEUTZ-ALLIS		
TIE ROD ENDS		
72090710V	5045, 5050	Tie Rod End w/ Stem - 2WD
72093230V	5045, 5050	Tie Rod Assembly, Includes Nut and Boot
70256144V	170, 175	Tie Rod End w/ Stem
72090448V	5040	Tie Rod Tube
72090708V	5045, 5050	Tie Rod Tube
72090449V	5040	Tie Rod End-Threaded
72091309V	5050	Tie Rod Assembly
72093231V	5050, 6060, 6060FWA	Tie Rod End-Threaded
4358268V	Vario Cab: 6240, 6250, 6260, 6265, 6275, DX3.30, DX3.70, DX3.90 Star Cab: 6260, 6265, 6275, DX3.50, DX3.70, DX3.90	Tie Rod End
72090115V	5045, 5050	Tie Rod End-Threaded
4358286V	Vario Cab: 6240, 6250, 6260, 6265, 6275, DX3.10, DX3.30, DX3.50, DX3.70, DX3.90 Star Cab: 6260, 6275, DX3.50, DX3.70, DX3.90-Star Cab	Tie Rod End w/ Tube
70269353V	7000, 7010, 7020, 7030, 7040, 7045, 7050, 7060, 7080, 8010, 8030, 8050, 8070	Tie Rod End w/ Stem
70254662V	D17 (Eff. SN 42001), D19, 180, 185, 190, 190XT, 190XT III, 200	Tie Rod End w/ Stem (50" Minimum Tread)
70254661V	CA, D14, D15, D17, (Prior to SN 42001), D19, 180, 185, 190, 190XT, 190XT III, 200	Tie Rod End w/ Tube (50" Minimum Tread)

Front Axle and Steering



70265527V



72094252V



4351104V



1810503V92



70256031V

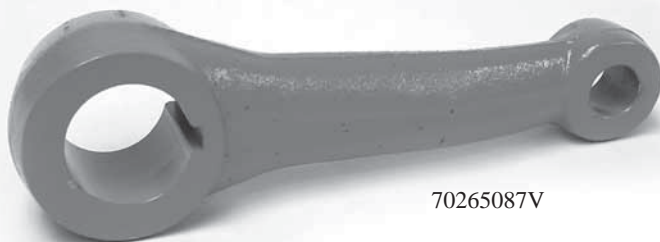

70265087V

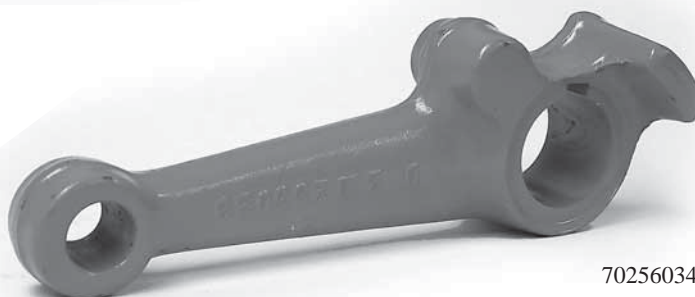

70256034V

Part No.	MUO	Description
----------	-----	-------------

ALLIS-CHALMERS, DEUTZ-ALLIS CONTINUED

TIE ROD ENDS

2311220V	7085, DX4.70, D10006, D13006, D6507C, D6806, D7007, D7007C, D7206, D7207, D7807, D7807C, D8006, DX90 76 Series, DX90 78 Series	Tie Rod End (Telescopic Axle)-Threaded
70265527V	7000, 7010, 7020, 7030, 7040, 7045, 7050, 7060, 7080, 8010, 8050, 8070	Tie Rod End LH-Threaded
72093532V	6080 (Prior to 6235)	Tie Rod End LH and RH-Threaded
72094252V	6080 (Eff. SN 6235)	Tie Rod End LH and RH
70256151V	170, 175 Roll Shift Axle, 6060, 6070 2WD	Tie Rod End LH and RH-Threaded
72093531V	6080 (Prior to SN 6235)	Tie Rod Assembly

STEERING ARMS

70265087V	7000, 7010, 7020, 7030, 7040, 7045, 7050, 7060, 7080, 8010, 8030, 8050, 8070	Arm, Steering RH and LH
70256031V	170, 175, 6060, 6070	Arm, Steering LH
70256034V	170, 175, 6060, 6070	Arm, Steering RH

UNIVERSAL JOINT

4311251V	2002/3/4, DX110 76 Series, DX120 76 Series, DX120 78 Series, DX90 76 Series, DX90 78 Series, Intrac 2002, Intrac 2003, Intrac 2004	U-Joint
----------	--	---------

POWER STEERING SEAL REPAIR KITS

1810503V92	6124, 6144S	Seal Kit, Steering Orbital Pump
------------	-------------	---------------------------------

POWER STEERING LINKAGE

4351104V	8010, 8030, 8050, 8070, 7085, DX4.70	Pivot Pin (Upper Steering Pin)
4358287V	Vario Cab: 6240, 6250, 6260, 6265, 6275, DX3.10, DX3.30, DX3.50, DX3.70, DX3.90 Star Cab: 6260, 6265, 6275, DX3.50, DX3.70, DX3.90	Hinge, Joint (Steering Cylinder)-Threaded

Front Axle and Steering

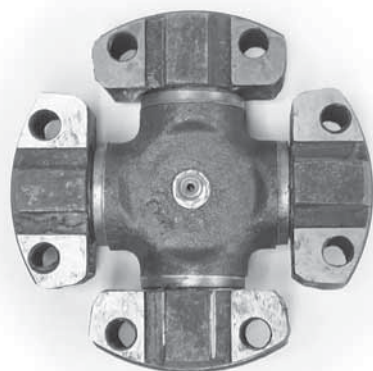

4315375V



4344814V

Part No.	MUO	Description
WHEEL BEARING KIT		
70228458V	WD, WD45, WD45D, D10, D12, D14	Wheel Bearing Kit
70263800V	D17, D19, 160, 170, 175, 180, 185, 190, 190XT, 190XT III, 200, 6060 2WD, 6070 2WD, 6080 2WD, 7000	Wheel Bearing Kit
70247803V	210, 220	Wheel Bearing Kit
1440634V1	5220 HST, 5220, 5230 Synchro-Shift, 6140	Wheel Bearing
70272748V	8010, 8030, 8050, 8070	Wheel Bearing
1110001V	Vario Cab: 6140, 6240, 6250, 6260, 6265, 6275, DX3.30, DX3.70, DX3.90 Star Cab: 6260, 6265, 6275, DX3.50, DX3.70, DX3.90 7145, 7085, 7110, 7120, DX7.10, DX4.70, DX6.30, DX6.50	Wheel Bearing
70247803V	210, 220, 220FWA	Wheel Bearing
FRONT AXLE FINAL DRIVE		
4315375V	8010, 8030, 8050, 8070	Spider & Bearing Assembly, U-Joint (Front Axle)
70272606V	8010, 8030, 8050, 8070	Spider & Bearing Assembly (w/ 8 Capscrews)
9962244V	5050, 6060, 6070, 6080	Spider & Bearing Assembly (Front Wheel Assist)
70272800V	8010FWA, 8030FWA, 8050FWA, 8070FWA	Bearing, Pinion (Ring Gear & Pinion Shaft)

3-Pt. Hitch and PTO



3400600V

Part No.	MUO	Description
ALLIS-CHALMERS, DEUTZ-ALLIS		
3-PT. HITCH-LIFT ARM COMPONENTS		
3400600V	Vario Cab: 6240, 6250, DX3.30 6250VF, 6260FV, 6275F, DX3.30VF, DX3.50VF	Ball (Cat I & II), Lift Arm
395574V1	6060, 6070, 6080	Bearing (Lift Screw for the top-link adjustment)
4308246V	7110, DX6.30	Connecting Rod Bar
70928809V	4W220, 4W305, 7010, 7020, 7030, 7040, 7045, 7050, 7060, 7080, 7580, 8010, 8030, 8050, 8070, 8550	Seal, Relief Valve Assembly (Lift Shaft Housing)

3-Pt. Hitch and PTO

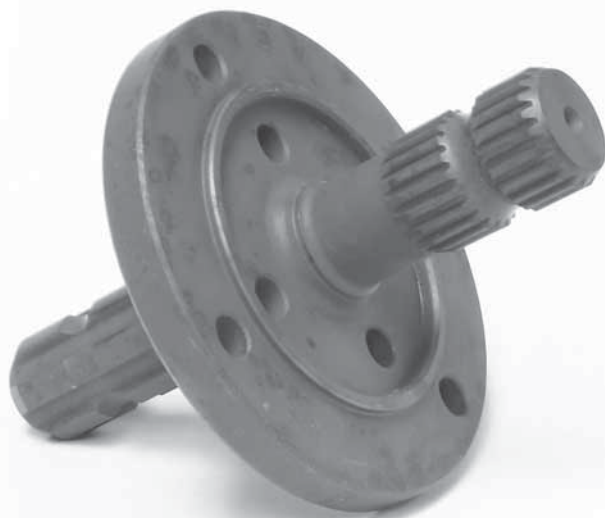

70255802V

Part No. MUO Description

ALLIS-CHALMERS, DEUTZ-ALLIS CONTINUED

DRIVELINE

70276115V	7580	Spider Bearing Assembly (Driveline)
70276116V	7580	Spider Bearing Assembly (Driveline)
70276117V	4W220, 7580	Spider Bearing Assembly (Driveline)
70255802V	170, 180, 185 (Prior to SN 12800), 190, 190XT, 200	2-Speed PTO Output Shaft
70260704V	175, 180, 185, 7000	2-Speed PTO Output Shaft (w/ Shuttle Clutch)
5149242V	6080	Output Shaft (1000 RPM), 21 Splines



1172625V



1440635V1

PTO BEARINGS AND SEALS COMPONENTS

1172625V	Star Cab: 6265, 6275, DX3.70, DX3.90 6265, 6275, DX3.90, 7110, 7120, 7085, DX6.30, DX6.50, DX4.70	Seal, Shaft (Front PTO/Transmission)
1109048V	4W220, 4W305, 5015, 5215 HST, 5215 Synchro-Shift, 7010, 7020, 7030, 7040, 7050, 7060, 7080, 7580, 8010, 8030, 8050, 8070	Bearing, w/ Shield (1000 RPM Shaft)
4304717V	7085, DX4.70 (Prior to SN 7434/3000 2WD and Prior to SN 7435/3000 4WD), 7110, DX6.30 (Prior to SN 7438/3000-7439/3000), 7120, DX6.50 (Prior to SN 7440/3000 & 7441/3000)	Bearing, Double Stub Shaft (Rear PTO)
2389720V	7085, DX4.70 (Prior to SN 7434/3000 2WD and Prior to SN 7435/3000 4WD), 7110, DX6.30 (Prior to SN 7438/3000-7439/3000)	Bearing, Tap, Roller (PTO Shaft)
1140823V	WC, WF	Bearing, Ball
1440635V1	7110, 7120, DX6.30, DX6.50	Bearing, Transmission Shaft, Front PTO
834218V1	6060FWA, 6070FWA, 6080FWA	Bearing, Shift Control
1109956V	6065 ROPS Vario Cab: 6240, 6250, 6260, 6265, 6275, DX3.30, DX3.70, DX3.90 Star Cab: 6260, 6265, 6275, DX3.50, DX3.70, DX3.90 6250VF, 6260FV, 6275F, DX3.30VF, DX 3.50VF	Bearing, Rear PTO Shaft
1110003V	7145, DX7.10	Bearing, Rear PTO (2 Speed)

Brakes

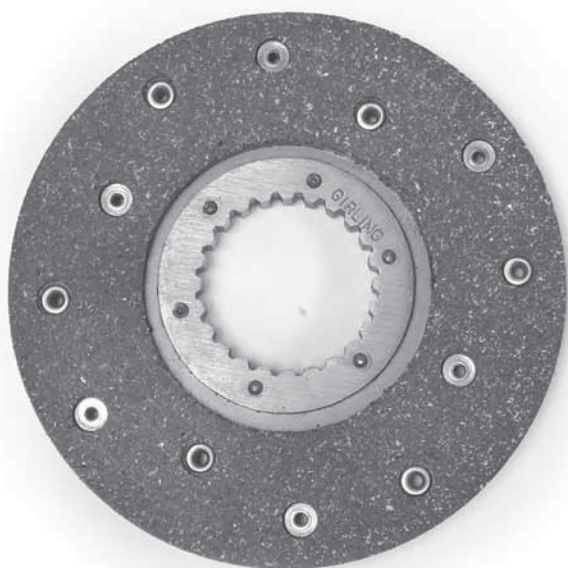

4377280V



4388716V



4377345V

Part No.	MUO	Description
BRAKE CYLINDER		
4388716V	Vario Cab: 6265, 6275, DX3.70, DX3.90 Star Cab: 6265, 6275, DX3.70, DX3.90	Brake Cylinder, RH
BRAKE DISCS		
4377280V	7120, DX6.50, DX76 Series, DX130 76 Series, DX130 78 Series	Brake Disc
2383780V	7120, DX6.50	Brake Disc
4399879V	D4507	Brake Disc
72092196V	6080 - Foot Control	Brake Disc - Friction
72093445V	6080	Brake Wear Plate - Fixed
SEAL, BRAKES		
5169561V	6080	Seal, Brake Foot Control
5169562V	6080	Seal, Brake Foot Control
CALIPER REPAIR KIT		
4377345V	7085, 7110, DX6.30, DX4.70	Kit, Repair (Single Caliper)

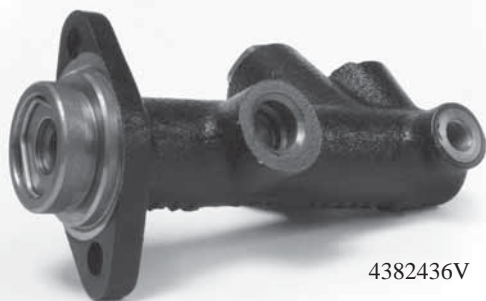

4382436V



86502678V

MASTER CYLINDER		
4382436V	Vario Cab: 7085, DX4.70 (Prior to SN 7434/0677 2WD) (Prior to SN 7435/2766 4WD), 6265, DX3.70	
4382438V	7120, DX6.50	
3384685V3	6124, 6144S	
STRUTS		
86502678V	6060, 6070, 6080	Strut
BRAKE ACTUATOR ASSEMBLY		
2383780V	7120, DX6.50, DX76 Series, DX130 76 Series, DX130 78 Series	Actuator Assembly

Clutch Components



For clarity, Heritage part numbers are shown in bold.

- All Heritage Clutch parts are new, not remanufactured
- Sets Includes Cover/Pressure Plate Assembly and Clutch Disc
- Bearings are not included in the Clutch Set

Since all major clutch repairs involve splitting the engine and transmission, it is recommended that you replace the cover assembly, drive plate and bearings if either the cover or disc is replaced.

TEST METHOD FOR CLUTCH SLIPPAGE

If the parking brake is applied and the transmission gears are shifted to top speed and the engine stops, the clutch is normal. If the engine does not stop, the clutch is slipping.

MUO	Heritage Part No.	OEM Part No.	Item	Size	Type	Flywheel Spec.	Spline Depth-# Teeth	Friction	Release Bearing Part No.	Pilot Bearing Part No.
-----	-------------------	--------------	------	------	------	----------------	----------------------	----------	--------------------------	------------------------

ALLIS-CHALMERS, DEUTZ-ALLIS

CLUTCH SET

B, C, CA, IB w/Rigid Disc	79022304	70226262	Cover	8.5"	Push	Flat			70204829	70205756
		70226729	Disc				1.125"-10 R	Woven		
B, C, CA, IB w/Dampened Disc	79022303	70226262	Cover	8.5"	Push	Flat			70204829	70205756
		79019101	Disc				1.125"-10 D	Woven		
D10 Prior to SN 3501, D12 Prior to SN 3001	79022302	70228926	Cover	9.0"	Push	Flat			70235079	70205756
		70236105	Disc				1.125"-10 D	Woven		
D10 Prior to SN 3501, D12 Prior to SN 3001 w/Button Disc	79022300	70247745	Cover	9.0"	Push	Flat			70235079	70205756
		70253187	Disc				1.125"-10 D	4-pad		
D10 Eff. SN 3501, D12 Eff. SN 3001	79022299	70228926	Cover	9.0"	Push	Flat			70204829	70205756
		70246660	Disc				1.250"-24 D	Woven		
D10 Eff. SN 3501, D12 Eff. SN 3001 w/Button Disc	79022298	70247745	Cover	9.0"	Push	Flat			70204829	70205756
		70248239	Disc				1.250"-24 D	4-pad		
D14, D15 w/Button Disc	79022300	70247745	Cover	9.0"	Push	Flat			70235079	70205756
		70253187	Disc				1.125"-10 D	4-pad		
D15G, D15D	79022296	70252548	Cover	10"	Push	1.188"			70235079	70205756
		70226764	Disc				1.250"-10 D	Woven		
D17 Prior to Series IV, Prior to SN 75000	79022295	70229344	Cover	11"	Push	1.437"			70235079	70205756
		70232241	Disc				1.250"-10 D	Woven		
D17 Prior to Series IV, Prior to SN 75000 w/Button Disc	79022294	70229344	Cover	11"	Push	1.437"			833084M1	70205756
		70247859	Disc				1.250"-10 D	4-pad		
D17 Series IV, Eff. SN 75001	79022292	70242572	Cover	11"	Push	1.437"	2.000"-30 Fixed		833084M1	70205756
		70247859	Disc				1.250"-10 D	4-pad		
D19	79022291	70247860	Cover	11"	Push	1.437"			833084M1	70205756
		70232241	Disc				1.250"-10 D	Woven		
D19 w/Button Disc	79022289	70247860	Cover	11"	Push	1.437"			833084M1	70205756
		70247859	Disc				1.250"-10 D	4-pad		
D21	79022287	70245984	Cover	14"	Push	2.052"	2.000"-15 Fixed		NA	NA
		70254769	Disc				1.375"-10 D	6-pad		
G	79022286	70222948	Cover	6.5"	Push	Flat			833084M1	70205756
		70800662	Disc				0.875"-10 R	Woven		
G138, G160	79022285	70228926	Cover	9"	Push	Flat			70204829	70205756
		70207784	Disc				1.125"-10 R	Woven		

Clutch set includes pressure plate and clutch disc unless otherwise noted.

D=Dampened
R=Rigid

Clutch Components

MUO	Heritage Part No.	OEM Part No.	Item	Size	Type	Flywheel Spec.	Spline Depth-# Teeth	Friction	Release Bearing Part No.	Pilot Bearing Part No.
CLUTCH SET CONTINUED										
G226 w/Button Disc	79022284	70247860	Cover	11"	Push	1.437"			70204829	70205756
		70241255	Disc				1.250-10 D	4-pad		
WC, WD, WD45,	70226764V	70216791	Cover	10"	Push	1.188"			833084M1	70205756
WF Early	Cover Only	70226764	Disc				1.250-10 D	Woven		
WC, WD,	79022282	70230506	Cover	10"	Push	1.188"			833084M1	70205756
WD45, WF Late	Cover Only	70226764	Disc				1.250-10 D	Woven		
170, 175 Less IPTO	79022289	70247860	Cover	11"	Push	1.437"			70235079	70205756
		70247859	Disc				1.250-10 D	4-pad		
170, 175 w/IPTO	79022292	70242572	Cover	11"	Push	1.437"	2.000-30 Fixed		70235079	70205756
		70247859	Disc				1.250-10 D	4-pad		
180, 185 Prior to SN 12800, 190	79022281	70255689	Cover	12"	Push	1.437"			833084M1	70205756V
		70247071	Disc				1.250-10 D	4-pad		
180, 185 Eff. SN 12800, 190, 190XT, 190XT III, 200	79022280	70255689	Cover	12"	Push	1.437"			72100765	72100764
		70261029	Disc				1.250-10 D	4-pad		
210, 220	79022287	70245984	Cover	14"	Push	2.052"	2.000-15 Fixed		72098054	K3352
		70254769	Disc				1.375-10 D	6-pad		
5015, 5215	7285056V	72085056	Cover	184mm	Push	Flat			72098054	K3352
		72101480	Disc				19mm-10 D	Woven		
5020, 5030 Single-Stage Clutch	79022279	72098568	Cover	215mm	Push	Flat			72089415	71135350
		72098360	Disc				25mm-13 D	Woven		
5020, 5030 Dual-Stage Clutch	3711469V91	3711469	Cover	8.5/8.5	Push	2mm			72089415	70263013
		3438914	Disc				19mm-10	Woven		
							36mm-19	Woven		
5040 6 & 9 speed, Early Production	30V3052249	72902073	Dual Cover	10/10	Push	Flat			72094287	Foot Release
		30-3052249	Trans Disc				40mm-14 R	Woven		
		72902071V	PTO Disc				25mm-10 R	Woven		
	Discs Only									
5040 6 & 9 speed, Late Production	30V3052249	72902073	Dual Cover	10/10	Push	1.140"			72093894	Hand Release
		30-3052249	Trans Disc				40mm-14 R	Woven		
		72902071V	PTO Disc				25mm-10 R	Woven		
	Discs Only									
5040 8 & 12 speed, 5045, 5050 w/6-Bolt Flywheel, Early Production	79022028	30-3010945	Cover	11/11	Push	Flat			72094287	Foot Release
		514715	PTO Disc				45mm-14 R	5-pad		
							25mm-10 R	Woven		
5040 8 & 12 speed, 5045, 5050 w/12-Bolt Flywheel, Late Production	79022018	72094463	Cover	11/11	Push	2mm			72091001	Hand Release
		72091671	PTO Disc				45mm-14 R	5-pad		
							25mm-10 R	Woven		
5230 Dual-Stage Clutch	3711469V	3711469	Cover	8.5/8.5	Push	2mm			72103232	NA
		3438914	Disc				36mm-19 R	Woven		
							19mm-10 R	Woven		
6040, 6060, 6070 w/12-Bolt Flywheel	79022018	72094463	Cover	11/11	Push	2mm			NA	70937250
		72091671	PTO Disc				45mm-14 R	5-pad		
							25mm-10 R	Woven		
7000 Prior to SN 8001	79022276	70260462	Cover	12"	Push	1.437"			833084M1	70205756
		70261029	Disc				1.250-10 D	4-pad		
7000 Eff. SN 8001 Torque Limiter	79022275	70261248	Cover	12"		1.437"			NA	70226859
		70261029	Disc				1.250-10 D	4-pad		

Clutch set includes pressure plate and clutch disc unless otherwise noted.

D=Dampened
R= Rigid

Clutch Components

MUO	Heritage Part No.	OEM Part No.	Item	Size	Type	Flywheel Spec.	Spline Depth-# Teeth	Friction	Release Bearing Part No.	Pilot Bearing Part No.
-----	-------------------	--------------	------	------	------	----------------	----------------------	----------	--------------------------	------------------------

ALLIS-CHALMERS, DEUTZ-ALLIS CONTINUED

CLUTCH SETS CONTINUED

7010, 7020, 7040, 7045, 7050, 7060, 8010 Powershift Trans	79022274	70269622 70268718	Cover Disc	12"		1.437"			4383379	4330107
7030, 7050, 7080, 7580 Torque-Limiting Disc	70269728V Disc Only	70269728	Cover Disc	12"		0.178"		1.375"-20 D 4-pad	NA	NA
7010, 7020, 7040, 7045, 7060, 8010, 8030, 8050, 8070 Power Director	70269728V Disc Only	70269728	Cover Disc	12"		0.178"		1.5"-23 D 4-pad	NA	NA
9130, 9150 Dealer: See Tech Note Included w/ clutch set	79022273	1041842M1 72160745	Cover Disc		Push	1.187"		1.75"-27 D 6-pad	72160065	1138894
9435, 9455 w/DDA Series 40 Engine, DT466 IH and 72505483 Flywheel Dealer: See Tech Note Included w/ clutch set	79022268	72163225 72163039 72161808 72163039	Cover Disc, Trans Side (Within Cover Assembly) Intermediate Plate (Within Cover Assembly) Disc, Engine Side	13/13	Push Flat Adapter (Attached to Cover Assembly)			1.75"-27 D 6-pad 1.75"-27 D 6-pad	72505831	72505492
4W220 Torque-Limiting Disc	70269728V	70269728	Cover Disc	12"		0.178"		1.5"-23 D 4-pad	NA	NA

Clutch set includes pressure plate and clutch disc unless otherwise noted.

D=Dampened
R=Rigid

Part No.	MUO	Description
CLUTCH ASSEMBLIES		
4360390V	7120, DX6.50 (Eff. SN 7440/0065-7440/0114, 7441/0358-7441/0744)	Single Clutch, Assembly (w/Load Switch)
4385900V	7145, DX7.10	Clutch Assembly
4392376V	6240 (Eff. SN 7722/1519 - 7726/0193), 6250, 6260, DX3.30-Vario Cab, 6275 F, 6260, DX3.50 Star Cab Only	Dual Clutch Assembly
4371470V	D3006	Clutch Assembly
4386629V	6250V, 6260F, 6260L, 6275F, 6275L, 7085, DX4.70, 7110, DX6.30	Dual Clutch Assembly

Part No.	MUO	Description
RELEASE BEARINGS		
4383378V	7085, DX4.70, 7110, DX6.30	
4383379V	6150, 7145, DX7.10, 7085, DX7.10, 7110, DX6.30 (3rd Design Eff. SN 7438/0329-3233, 2nd Design Eff. SN 7439/2577 - 4026), 7120, DX6.50	
70937250V	7110, DX6.30, 6240, 6260, 6265, DX3.70, 6275, DX3.90-Vario Cab, 6260, DX3.50, 6265, DX3.70, 6275, DX3.90, 6250, DX3.30VF, 6260, DX3.30FV, 6275F	
71195913V	6250, DX3.30-Vario Cab, 6080, 6250VF, 6260FV, DX3.30VF, DX3.50FV, 6275F	

Clutch Components



4383379V



4378769V

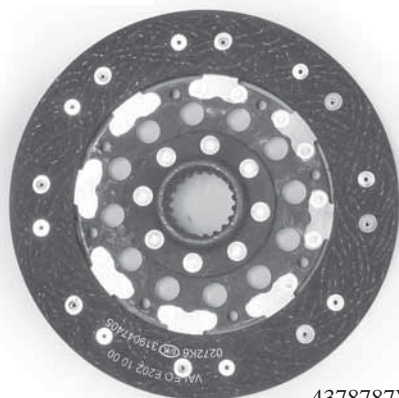

4378787V

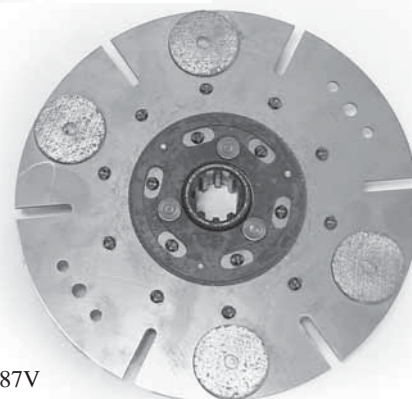

70253187V

Part No.	MUO	Description
RELEASE BEARINGS CONTINUED		
4383378V	7085, DX4.70, 7110, DX6.30	
4383379V	6150, 7145, DX7.10, 7085, DX7.10, 7110, DX6.30 (3rd Design Eff. SN 7438/0329-3233, 2nd Design Eff. SN 7439/2577-4026), 7120, DX6.50	
70937250V	7110, DX6.30, 6240, 6260, 6265, DX3.70, 6275, DX 3.90-Vario Cab, 6260, DX3.50, 6265, DX3.70, 6275, DX3.90, 6250 DX3.30VF, 6260DX3.30FV, 6275F	
71195913V	6250, DX3.30-Vario Cab, 6080, 6250VF, 6260FV, DX3.30VF, DX3.50FV, 6275F	
CLUTCH DISCS		
72094507V	5040	Clutch Disc, Facing & Rivets (12 Rivet holes)
4359406V	7120, DX6.50 (Prior to SN 7440/0065 & 7441/0358)	Disc, Clutch (w/ Load Switch)
4378233V	6275F	Disc, Clutch
4378763V	6240 (Eff. SN 7722/0519-7726/0193), 6250, 6260, DX3.30-Vario Cab, 6250V, 6260F, 6260, DX3.50-Star Cab, D5206, D5207, D5506, D6206, D6207, D6507, D6507C	Dual Clutch Disc
4378769V	6275F, 6275L	Dual Clutch Disc
4378787V	6240 (Prior to SN 7722/0517-7726/0191-Vario Cab), 6035, D3607, D3006, D4006, D4506, D4507	Dual Clutch Disc
4386637V	7085, DX4.70, 7110, DX6.30	Clutch Disc
4378779V	7085, DX4.70	PTO Disc
70253187V	D10 (Prior to SN D10-3501) D12 (Prior to SN 3001), D14	Disc Assembly, Driven
72091671V	5040 (8 & 12 Speed), 5045, 5050 (Eff Tractor SN 574157), 6060, 6070	Plate, Driven Clutch
FOOT RELEASE REPAIR KIT		
1140823V	D14	Bearing, Clutch Shaft

Transmission Components



1138480V



70276826V



1109058V

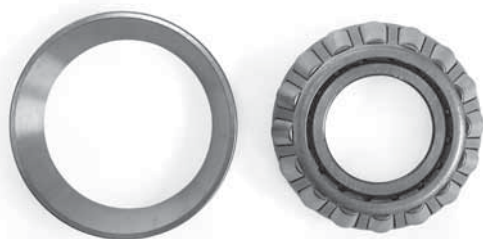

1101386V



1126121V

Part No.	MUO	Description
ALLIS-CHALMERS, DEUTZ-ALLIS		
TRANSMISSION COMPONENTS		
3009853V1	6140	Bearing, (Hi & Lo Range Gears & Shaft)
1138480V	7110, DX6.30 (Prior to SN 7438/3233-7439/4026)	Bearing, Change Speed Gear Box (Drive Quill)
3009853V1	5040 (8 & 12 Speed) (Eff. SN 475807)	Bearing, Differential & Final Drive, RH
70276826V	6045, 6085, 7010, 7020, 7040, 7045, 7060, 8010 (Prior to SN 2291), 8030 (Prior to SN 2727), 8070	Bearing, Transmission (Front Bearing)
71117404V	7085, DX4.70 (Eff. SN 7434/3439, 7435/4574), 7110, DX6.30 (Eff. SN 7438/3233-7439-4026)	Bearing, Transmission
1109058V	5660, 5650	Bearing, Transmission (Main Shaft)
1138480V	6265, DX3.70, 6275, 3.90-Star Cab, 6265, DX3.70, 6275, DX 3.90- Vario Cab, 7085, DX4.70 (5 Speed, Prior to SN 7434/34396 & 7435/4574)	Bearing, Transmission Input shaft Assembly
1101386V	7145, DX7.10	Bearing, Transmission, Change Speed Gear Box (Main Shaft)
185251V1	7010, 7020, 7040, 7045, 7060, 8010, 8030, 8050, 8070	Cone Bearing, Rear, Transmission
185252V1	7010, 7020, 7040, 7045, 7060, 8010, 8030, 8050, 8070	Cup Bearing, Rear, Transmission
1126121V	7085, 7110, 7120, DX4.70, DX .30, DX6.50	Differential Gear - Bottom (59-1/2") (151.13cm)
4314677V	6265, 6275, DX3.70, DX3.90-Star Cab, 6265, 6275, DX3.70, DX3.90-Vario Cab	Gear 18T (Intermediate Shaft)
70276826V	5660, 5650	Bearing, Transmission

Rear Axle



195160V1



70528519V

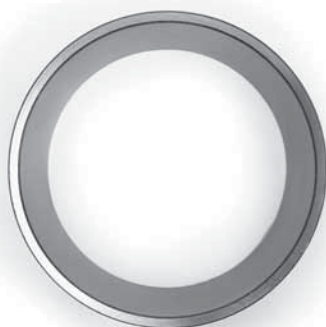

195160V1



72090424V

Part No.	MUO	Description
BEARINGS		
195160V1	WC, WF, D19, 190, 190XT (Prior SN 9001)	Bearing, Final Drive Gear
391336V1	6265, 6275, DX3.70, DX3.90-Star Cab, Vario Cab	Bearing, Intermediate Shaft
70528519V	4650, 4660, 4W305, 5015, 5020 (Hi & Lo Range, 21hp 8-Speed (Prior to SN 5020-02691), 5020 FWD, 5030, 5050 FWA, 5215 HST, 5215 Synchro-Shift, 5220 HST, 5660, 5650 (16x8 Transmission), 6045, 6080, 6105, 6140	Bearing, Main Shaft (Transmission)
195160V1	175, 180, 185	Bearing, Outer, Rear Axle
391337V1	6140	Bearing, Rear Differential
1440640V1	5220 HST, 5220 Synchro-Shift	Bearing, Rear Differential
3009853V1	5050 (Eff. Tractor SN 568766)	Bearing, Rear Differential
195160V1	7010, 7020, 7030, 7040, 7045, 7050, 7060, 7080, 8010, 8030, 8050	Bearing, Transmission
195160V1	4W-220, 7580	Bearing, Transmission Drop Box
72090067V	5020, 5020FWD, 5030, 5660, 5670 (Prior SN 1500), 5680 (Prior to SN 1501), 6060, 6070, 6085, 6090, 6670, 6680, 6690, 8610, 8630S	Taper Roller Bearing, Rear Differential
72090067V	5040 (Prior to Tractor SN 475807), 5050 (Prior to Tractor SN 568766)	Taper Roller Bearing, Rear Differential, LH
SEALS		
70244961V	WC (Prior to WC-74330), WF (Prior to WF-1336)	Oil Seal (Belt Pulley)
70244961V	D10, D12S, D15	Oil Seal (Rear Axle)
677346V	5040, 5045, 5050	Seal (Type 2) Final Drive Gear
72094099V	6060, 6070	Seal, Axle
72090424V	5040 (6 & 9 Speed), 5045, 5050 (Eff. Tractor SN 575730)	Seal, Differential
70206450V	B, IB, C, CA	Seal, Oil (Rear Axle)
70271736V	D17, 170, 175, 180, 185	Seal, Oil (Rear Axle)
70261958V	B, IB, C, CA, D10, D12S, D14, D15	Seal, Oil, Pinion Shaft, Inner
72093243V	5040, 5045, 5050	Seal, PTO Output
72093445V	6080	Spacer, Final Drive Housing

Hydraulics

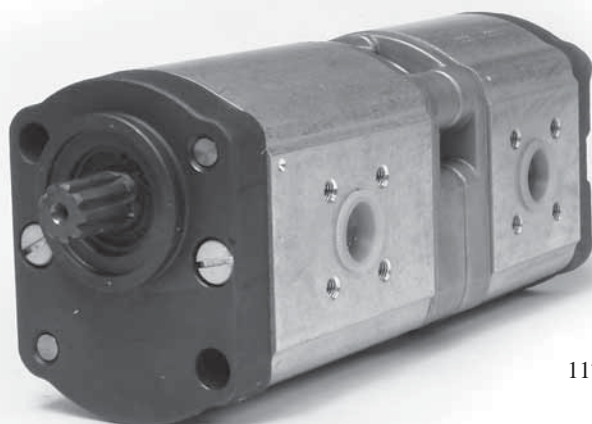

1176451V



4329742V



4360637V

Part No. MUO

ALLIS-CHALMERS, DEUTZ-ALLIS

HYDRAULIC PUMP ASSEMBLIES

1176452V	6240, 6250, DX3.30, 6260-Vario Cab, 6260, DX 3.50-Star Cab, 7120, DX6.50
5179722V	5040, 5045, 5050 (Eff. Tractor SN 593658)
1174210V	7085, DX4.70
1176451V	7110, DX6.30, 7120, DX6.50
1176000V	6275F, 6275L, 6265, DX3.70, 6275, DX3.90-Star Cab, 6265, DX3.70, 6275, DX3.90-Vario Cab
1175656V	6240-Vario Cab
4329742V	7085, DX4.70, 7110, DX6.30

MAIN HYDRAULIC CONTROL UNIT

4360637V	6150, 6240, 6250, DX3.30, 6260, 6265, DX3.70, 6275, DX3.90-Vario Cab, 6250VF, DX3.30VF, 6260, DX3.50VF, 6275F
----------	---

From the Allis-Chalmers™ Parts Marketing Archives

A look through the Allis-Chalmers™ Parts photo files from the 1970s reveals certain themes that still apply today.

The More Things Change...

Brands change with the times. Technology is a moving target. And what defines a successful parts manager involves more than just getting out from behind the parts counter.

Brand. The Allis-Chalmers™ brand evolved over the 20th century, from the A-C Milwaukee emblem of the first half, to the Allis-Chalmers™ triangle introduced in the mid-1960s. In 1990, to reflect the new corporation, A-C orange was paired with an updated triangle.

In 2006, the AGCO logo underwent yet another update, with an ‘out-of-the-box’ red triangle. Future Heritage® parts catalogs will feature this logo paired with a new AGCO® Parts signature.

Technology. In 1970, the Allis-Chalmers™ “Instant Data” Microfiche Reader was state-of-the-art. The Card-based Parts Control System promised to modernize a dealer’s Parts Record System. And an order pad was the way to order parts.

Today, an AGCO dealer orders parts electronically. The dealer’s Business System integrates order records with dealer inventory, producing a myriad of management reports. And the AGCO Epsilon® System publishes and distributes parts books and manuals to AGCO dealers and distributors worldwide.

Parts Personnel. In 1970, a parts manager was urged to come out from behind the counter to sell more parts (*top*). Proper parts manager attire included a shirt and tie. And a parts manager was expected to know everything about a customer and a customer’s equipment when that customer came to the counter.

Today, business attire has relaxed. However, a parts manager is still expected to sell parts, whether in front of or behind the counter. And he or she is still expected to know their customer and their customer’s equipment when that customer comes to the counter. Seems some things don’t change.

For more things that don’t change, see the following pages.

Editor Note: Several photo file cabinets dating from the 1950s through the 1980s somehow escaped being purged during the Allis-Chalmers Parts move from Milwaukee, Wis., to Batavia, Ill.

We share some of these photos here for your enjoyment.

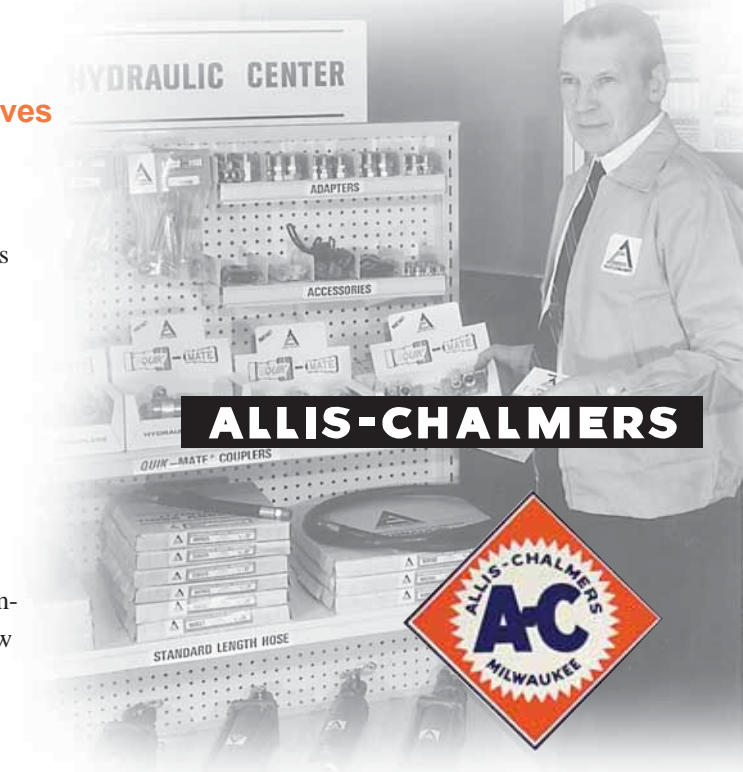

Order Pad



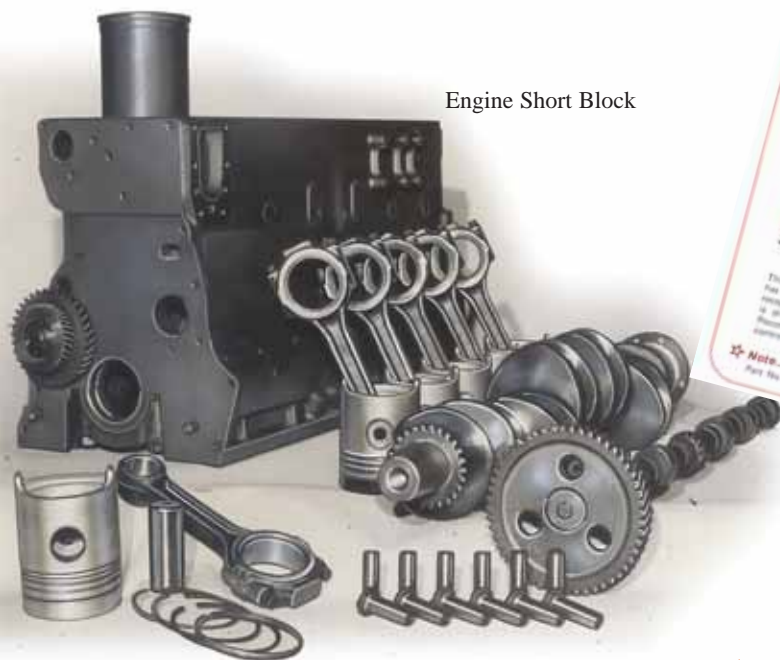

Engine Short Block



Power Plant

...The More Things Stay the Same.

POP displays and merchandising translate to increased sales.

Product variety means more customer value and increased sales.

Toys and clothing support the brand, and help increase sales.



Point-of-purchase (POP)
Display Early 1970s



A-C Paint
Corporate Orange



A-C Brand Grain Moisture Tester

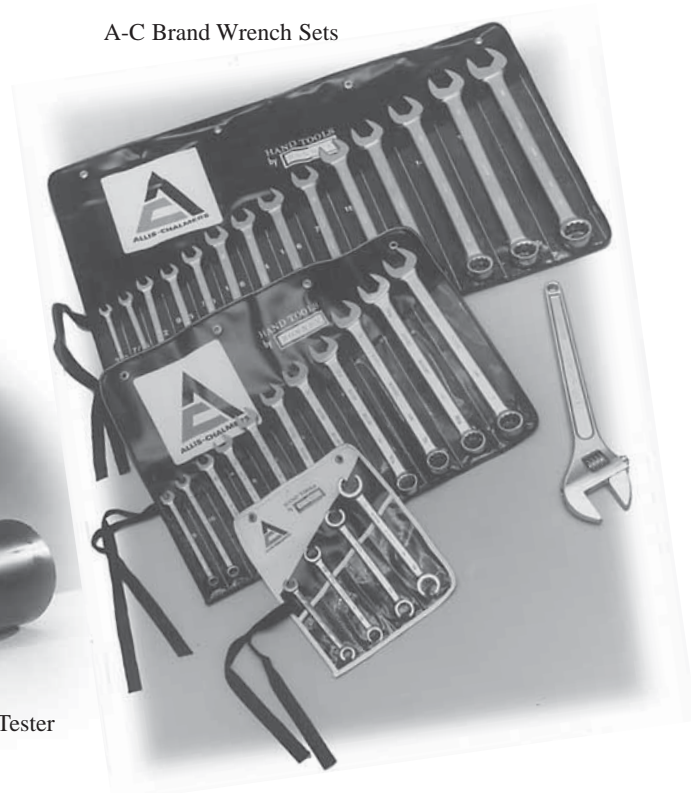

A-C Brand Wrench Sets



Lubricants and Chemicals



A-C Brand Battery

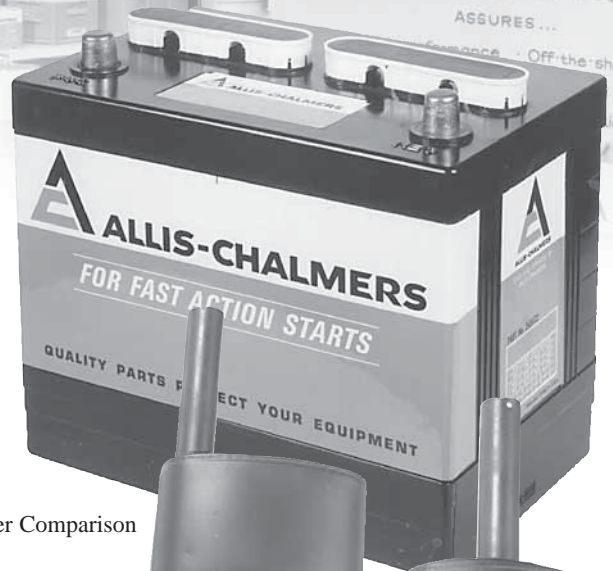

Muffler Comparison

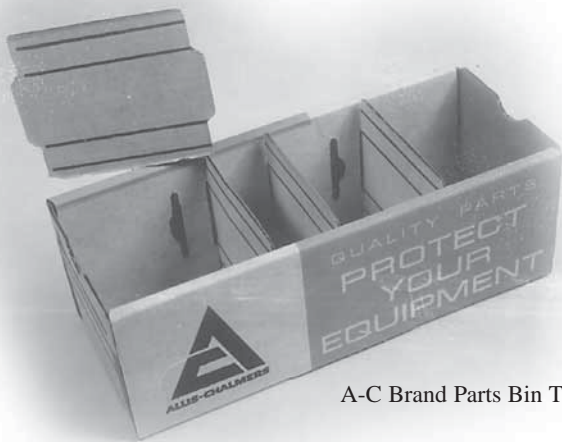

A-C Brand Parts Bin Tray

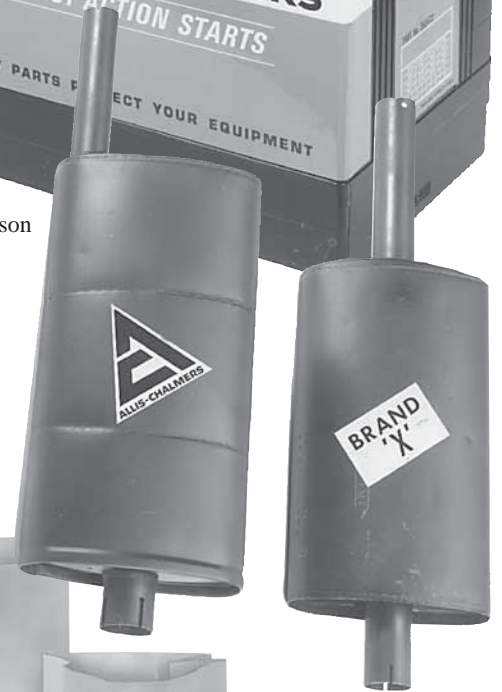

A-C Brand Retail Bags

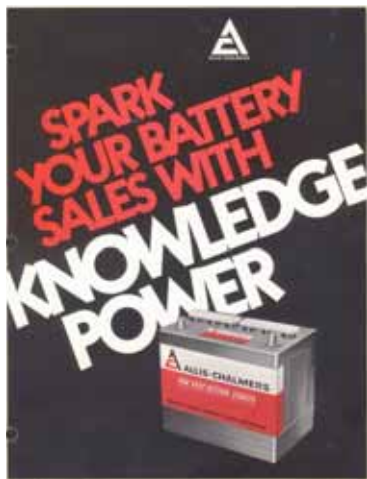

Sales Literature



circa 1990

Just One of 1000s of Ways

To Keep Your Allis-Chalmers™ Tractor Running Like New.



Get Original Quality At An Attractive Price.

The expanded AGCO® Heritage® parts line now includes O.E.-approved parts for a wider range of older tractors, including Allis-Chalmers™, Deutz-Allis, AGCO®-Allis and Deutz-Fahr. We've got every area covered, from clutch, electrical, engine and transmission, to cab kits, decals and paint. Only Heritage® parts are designed to the original and backed by a full 12-month warranty.

Whether you farm, collect, or both, you'll appreciate the quality and price of Heritage® parts, available from participating AGCO Dealers.



Original Quality. Original Performance. One-Year Warranty.

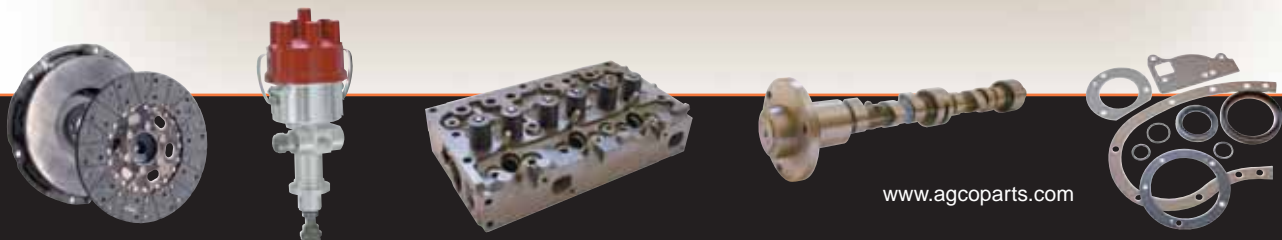

www.agcoparts.com

Deutz-Fahr® is a registered trademark of Same Deutz-Fahr S.p.A.

Watch for the Entire Heritage® Parts Catalog Collection

